

nord drum
virtual analog drum synthesizer

User Manual

Nord Drum



CAUTION - ATTENTION

RISK OF ELECTRIC SHOCK
DO NOT OPEN
RISQUE DE SHOCK ELECTRIQUE
NE PAS OUVRIR



The lightning flash with the arrowhead symbol within an equilateral triangle is intended to alert the user to the presence of uninsulated voltage within the products enclosure that may be of sufficient magnitude to constitute a risk of electric shock to persons.

Le symbole éclair avec le point de flèche à l'intérieur d'un triangle équilatéral est utilisé pour alerter l'utilisateur de la présence à l'intérieur du coffret de "voltage dangereux" non isolé d'ampleur suffisante pour constituer un risque d'électrocution.



The exclamation mark within an equilateral triangle is intended to alert the user to the presence of important operating and maintenance (servicing) instructions in the literature accompanying the product.

Le point d'exclamation à l'intérieur d'un triangle équilatéral est employé pour alerter l'utilisateur de la présence d'instructions importantes pour le fonctionnement et l'entretien (service) dans le livret d'instructions accompagnant l'appareil.

CAUTION: TO REDUCE THE RISK OF ELECTRIC SHOCK
DO NOT REMOVE COVER (OR BACK).
NO USER SERVICEABLE PARTS INSIDE.
REFER SERVICING TO QUALIFIED PERSONNEL.

ATTENTION: POUR EVITER LES RISQUES DE CHOC ELECTRIQUE, NE PAS ENLEVER LE COUVERCLE.
AUCUN ENTRETIEN DE PIECES INTERIEURES PAR L'USAGER.
CONFIER L'ENTRETIEN AU PERSONNEL QUALIFIE.
AVIS: POUR EVITER LES RISQUES D'INCIDENTE OU D'ELECTROCUTION, N'EXPOSEZ PAS CET ARTICLE A LA PLUIE OU L'HUMIDITE.

Instructions pertaining to a risk of fire, electric shock or injury to persons.

IMPORTANT SAFETY INSTRUCTIONS

SAVE THESE INSTRUCTIONS

Warning - When using electric products, basic precautions should always be followed, including the following:

- 1) Read these instructions.
- 2) Keep these instructions.
- 3) Heed all warnings.
- 4) Follow all instructions.
- 5) Do not use this apparatus near water.
- 6) Clean only with dry cloth.
- 7) Do not block any ventilation openings. Install in accordance with the manufacturer's instructions.
- 8) Do not install near any heat sources such as radiators, heat registers, stoves, or other apparatus (including amplifiers) that produce heat.
- 9) Do not defeat the safety purpose of the polarized or grounding-type plug. A polarized plug has two blades with one wider than the other. A grounding type plug has two blades and a third grounding prong. The wide blade or the third prong are provided for your safety. If the provided plug does not fit into your outlet, consult an electrician for replacement of the obsolete outlet.
- 10) Protect the power cord from being walked on or pinched particularly at plugs, convenience receptacles, and the point where they exit from the apparatus.
- 11) Only use attachments/accessories specified by the manufacturer.
- 12) Use only with the cart, stand, tripod, bracket, or table specified by the manufacturer, or sold with the apparatus. When a cart is used, use caution when moving the cart/apparatus combination to avoid injury from tip-over.
- 13) Unplug this apparatus during lightning storms or when unused for long periods of time.
- 14) Refer all servicing to qualified service personnel. Servicing is required when the apparatus has been damaged in any way, such as power-supply cord or plug is damaged, liquid has been spilled or objects have fallen into the apparatus, the apparatus has been exposed to rain or moisture, does not operate normally, or has been dropped.



Additional Safety Information

No naked flame sources, such as lighted candles, should be placed on the apparatus;

Do not use the apparatus in tropical climates.

WARNING: To reduce the risk of fire or electric shock, do not expose this apparatus to rain or moisture.

The apparatus shall not be exposed to dripping or splashing and that no objects filled with liquids, such as vases, shall be placed on the apparatus.

The mains plug is used as the disconnect device and shall remain readily operable.

Il convient de ne pas placer sur l'appareil de sources de flammes nues, telles que des bougies allumées;

L'appareil n'est pas destiné à être utilisé sous un climat tropical.

L'appareil ne doit pas être exposé à des égouttements d'eau ou des éclaboussures et de plus qu'aucun objet rempli de liquide tel que des vases ne doit être placé sur l'appareil.

Lorsque la prise du réseau d'alimentation est utilisée comme dispositif de déconnexion, ce dispositif doit demeurer aisément accessible.

Trademarks: The Nord logo is trademark of Clavia DMI AB. All other trademarks mentioned in this publication are the properties of their respective holders.

Specifications and appearances are subject to change without notice.

Copyright © Clavia DMI AB



Nord Drum User Manual

1 Stand holder & connections

Attaching the stand holder	4
Connections	4
MIDI In, MIDI Out	4
Trig Inputs CH1 - CH4	5
Power	5

2 Getting Started

Connecting pads	6
Adjust Input Sensitivity	6
Threshold	6
Play the Demo	7
MIDI Channel Learn	7
MIDI Note Learn	7
Four Modes	7
Basic editing	8
The Red parameters	8
Solo Edit	8
Memory Protect	9
Storing	9

3 Reference

The Panel	10
Program Store button	10
Input Trig Level LEDs	10
Channel Select button	10
Sound Init	11
Shit/Exit button	11
Dial	11
Trig button	11
Parameter buttons	11
Noise Parameters	11
Color	11
Filter/Type	11
Sweep/Time	11
Decay/Gate	12
Mixer Parameters	12
Tone, Noise, Click Level	12
Channel level	12
Tone Parameters	12
Wave	12
Filter/Punch	12
Sweep/Time	12
Decay/Gate	13
Pitch	13
Bend Range/Bend Time	13
Click Parameters	13
Type	13
Decay/Gate	13
Shift Parameters	13
Copy	13
Paste	14
Prog Dump	14
MIDI Ch	14
MIDI Note	14
Trig Type	14
Inp Thres	15
Inp Sens	15
MIDI Operation	15
Storing the memory content	15
Receive MIDI Dumps	16
Updating the Operating System	16

APPENDIX

Factory Soundbank	17
-----------------------------	----

1 Stand holder & connections

Attaching the stand holder

The stand holder makes it possible to mount the Nord Drum on a stand that is equipped with a clamp. The stand holder with its diameter of 23 millimeter is designed to fit with most general purpose clamps.

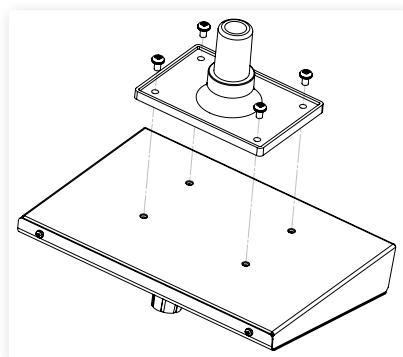

Connections

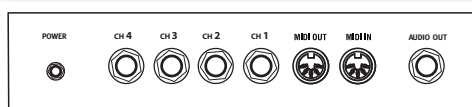

Audio Out

The Audio output is a line level, mono signal on a 1/4" jack.

- ⚠ *Always turn on the Nord Drum first and the sound system last, and the reverse order when you wish to turn it off again.*
- ⚠ *The Nord Drum is capable of producing sounds with a very wide and rapidly changing dynamics and frequency ranges. Be careful when you use the unit and when you edit the sounds. Keep the level at moderate settings, in order not to overload a connected sound system by making drastic changes with the available parameters.*

MIDI In

Connect the MIDI Input to a drum pad or sequencer if you want to control the sounds in the Nord Drum via MIDI. The MIDI Input is also used to update the unit with new operating systems.

MIDI Out

Connect the MIDI Output to a computer or sequencer if you want to use the Program Dump feature to transfer the settings to the sounds in the Nord Drum via MIDI. A performance on pads connected to the Trig Inputs will also be transmitted as MIDI notes.

Trig Inputs CH 1 – CH 4

Connect a suitable signal source to the Trig Input ¼" jacks. These inputs can be used with a variety of different signals. The sensitivity and the threshold of the inputs can be adjusted by using the Inp Sens and Inp Thres parameters, read more about this in the following chapter.

The Nord Drum has been tested with many different pads during the development. The Trig Inputs are designed to be very versatile and to accept many different kinds of signals. They are able to provide you with a very fast and dynamic response.

If you experience double triggered sounds, flams or a slow response from the Nord Drum, make sure that you adjust the Trig Type, Inp Thres and Inp Sens parameters. Read more on how to adjust these settings this on page 6 and page 14.

Power

Connect the Nord Drum power supply to the Power input. If the original supply is not available, use only a 12 volt DC, 250 mA adapter, with a barrel type plug that has the positive current on the tip. The outer diameter of the plug is 5.5 millimeter and the inner diameter is 2.1 millimeter.

2 Getting Started

Connecting pads

- 1 Connect a pad to one of the four Trig Inputs on the Nord Drum. The Trig Inputs can be used with mono or stereo connections.

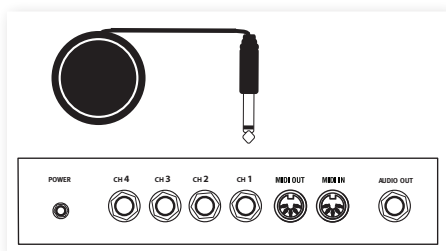

In general, the factory sounds use Channel 1 for Bass drum sounds, channel 2 for Snare, channel 3 for Hi tom and channel 4 for Lo Tom.

Adjust Input sensitivity

- 1 Strike the pad, listen to the sound from the Nord Drum and look at the Input Trig Level LEDs for that particular channel. The LEDs indicate the strength of the incoming trigger signal.
- 2 The red LED should be lit a bit longer when you hit the pad with your strongest force.

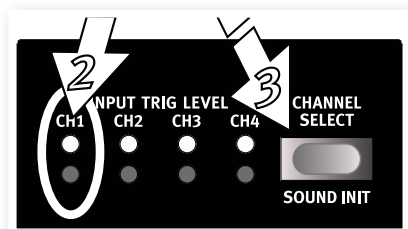

- 3 Press the Channel Select button to move the solid green LED to the channel that the pad is connected to. This is called to move the Edit focus, you set the unit to be ready to change the settings on that particular channel.
- 4 Hold Shift and press the Inp Sens button on the Nord Drum panel. The red LED above the button will start to blink to indicate that the parameter printed below the second row is active for editing.
- 5 Strike the pad and adjust the Input sensitivity by turning the Dial to match the pad response and your striking force.



Threshold

If you have several pads or other pieces in your kit that are mounted on the same hardware, use the Inp Thres parameter to eliminate any unwanted, accidental triggers from other units.

- 1 Select the Channel that is receiving the unwanted triggers.
- 2 Hold Shift and press the Inp Thres button.



- ③ Strike the pad or drum that causes the unwanted triggers and raise the Inp Thres value with the dial until the Nord Drum channel stops triggering.
- ④ Strike the pad that should trigger the Nord Drum to verify that the new Inp Thres setting has not changed the desired response.

Play the Demo

- ① Press the Program, Channel Select and Trig buttons simultaneously to start the Demo playback.
- ② Turn the Dial while the demo is playing to listen to the various sounds in the Factory soundbank.
- ③ Press Shift/Exit to stop the playback.

MIDI Channel Learn

If you wish to control the Nord Drum with a MIDI controller, the MIDI channel and the notes that this controller transmits can be automatically assigned by the Nord Drum to trigger the four channels.

- ① Connect a MIDI pad or other MIDI controller to the MIDI Input on the Nord Drum.
- ② Press Shift and the MIDI Ch button and scroll with the Dial until you reach “L r n”.

❗ *The LED above the MIDI Ch button will flash to indicate that you are editing System parameters.*

- ③ Transmit a MIDI note or other message from the MIDI controller. The incoming channel will be displayed in the LED.

❗ *The Nord Drum can only receive on one MIDI channel at a time.*

MIDI Note Learn

- ① Connect a MIDI pad or other MIDI controller to the MIDI Input on the Nord Drum.
- ② Press the Channel Select button on the Nord Drum to select one of the channels.
- ③ Hold Shift and press the MIDI Note button. Turn the dial until you reach the setting after 127, “L r n”.
- ④ Strike the pad on the MIDI unit that you wish to assign to the selected Nord Drum channel.

The note number that the MIDI pad transmitted will be assigned to this Nord Drum channel and will be shown in the display.

- ⑤ Repeat steps 2, 3 and 4 to assign the other three channels to the additional MIDI note numbers that the MIDI unit transmits.
- ⑥ Press the Program button to Exit the System edit mode.

Four Modes

When the display shows the letter P followed by a number, this is the Program Mode. Turn the Dial to select any of the 99 programs.

When one of the red LEDs in the two rows below the LED is lit and the display shows one or two sets of numbers, this is the Edit Mode where you can change the settings of the selected parameter with the Dial.

The Solo Edit Mode is active if you hold Shift and press the Row Select/Solo Edit button. Only the component that is currently being edited will be heard when you trigger the channel.

When one of the lower row LEDs are flashing, this means that the System Mode is active where the parameter printed below the second row button is adjustable with the Dial.

Basic editing

The Nord Drum has 4 channels, it can produce 4 simultaneous sounds. Each one of the channels has a complete and identical set of parameters.

A sound in the Nord Drum is made with a blend of up to three components: Noise, Tone and Click. Each one of these components has their individual set of parameters.

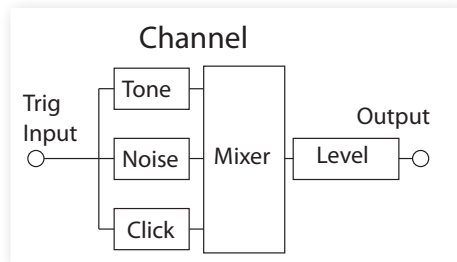

- 1 Use the Trig button in the lower right corner to play the sound on one channel at a time. Triggering sounds from the panel are made with a fixed velocity.

💡 *If you have pads connected, these can be used as well and will make the sounds respond to the velocity of your playing.*

- 2 Press the Channel Select button repeatedly to select one of the four channels.

The channel parameters are accessed with the grid of two rows with eight buttons.

- 3 A parameter is selected by simply pressing a button. This will activate Edit Mode and the display will show parameter values.

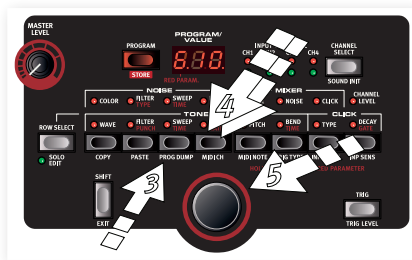

- 4 To change the row to the lower set of parameters, double-tap on a parameter button or use the Row Select button to the left.
- 5 Turn the Dial to change the setting of a parameter.
- 6 Press the Channel Select button repeatedly to select which one of the four channels to edit.

The Red parameters

Eight of the buttons have additional parameters assigned to them, indicated with red text. These are displayed with dual values in the display with the red parameter to the left.

- 1 The additional left value is changed by holding down the parameter button and then turning the Dial.

Solo Edit

The Solo Edit feature can be used to playback only the Noise, Tone or Click components when you select the parameters for these. This allows you to edit the parameters and only hear the particular component you are working with in isolation.

- 1 Hold Shift and press the Row Select/Solo Edit to activate the Solo Edit mode.



- 2 Strike a pad or use the Trig button to hear only the component that is currently being edited.

 If the Channel Level parameter is selected, all components will be heard.

- 3 Press the Program button to exit the Solo and Edit mode. The LED will show a P followed by a program number.

Memory Protect

When the Nord Drum is shipped from the factory, storing programs to the memory is not possible until you turn off the Memory protection. This is done with one of the System parameters.

 If the Memory Protect is On, the display will show "P r t" when you try to Store a Program

- 1 Hold Shift and press repeatedly on the Prog Dump button until "P On" is shown in the display.
- 2 Turn the Dial to the "P On" setting.

This will allow you to store programs until this parameter is set to On again.

- 3 Exit the System mode by pressing the Program button.

Storing

When a Program has been changed, this is indicated with a dot to the right of the program number.

If you select another program, your edits will be lost. If you want to keep any changes you have made, you have to Store the edited program.

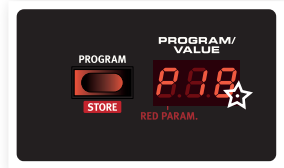

- 1 Hold Shift and press the Program/Store button.
- 2 The display will start to blink.



- 3 Press Program/Store again without turning the Dial to store the edited program to the current location.

Storing to a new location

- 1 Hold Shift and press the Program/Store button. The display will start to blink.
- 2 Use the Dial to pick a location for the new Program.
- 3 Confirm your intentions by pressing Store a second time.

This method can also be used to make copies of a Program.

3 Reference

The Panel

Master Level

The Master Level controls the overall output level of the Nord Drum. This is not a programmable control.



Program/Store button

Press the Program button to exit any other mode and to enter the Program mode. The LED display will show a P followed by a number. There are 99 programs in the Nord Drum.

- ❗ *If a program has been edited but not yet stored, this will be indicated by a dot in the lower right corner of the LED.*

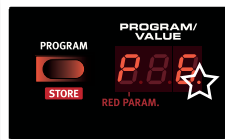

Storing a program

Storing a Program is described on page 9.

Program/Value LED display

Program mode is indicated with a P, followed by a number between 1 and 99.



Edit mode is when a parameter in the Nord Drum is selected. The presentation of the settings will be made with numbers and/or symbols. Some parameters have dual settings, one indicated to the right and the other to the left in the display.

When you want to change one of the red parameters, hold down the parameter button and turn the dial.



Solo Edit mode is activated by holding Shift and pressing the Row Select/Solo Edit button. The Solo Edit LED will blink and only the component that is being edited will be heard.

System mode is when the System parameters are selected by holding Shift and pressing a parameter button.

Input Trig Level LEDs

The Input LEDs will flash to indicate the activity in the four channels. A solid green LED indicates that a channel is selected for editing.

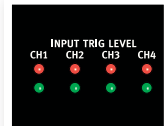

The upper LEDs are red and will flash briefly when a trigger input receives a strong signal. It will be lit up in a longer duration when the input receives an optimal, as-hard-as-you-can-strike signal.

Channel Select button

Press the Channel Select button repeatedly to select the channel to be triggered with the Trig button on the panel and/or to be edited with the parameters.



- 💡 *You can use pads to quickly select the channel to edit, if no channel has been previously selected with the Channel Select button. If the button has been used to manually select a channel, press the Program button once to get back to the quick-select-edit-channel-by-pads mode (QSECBP™).*

Sound Init

Hold Shift and press the Channel Select button to reset all the parameters of this channel to default values.

Shift/Exit Button

The Shift button is used together with the buttons to access additional parameters. These additional parameters are identified with the text below the buttons.

The Shift button can also be used to Exit a Store operation, if you change your mind about storing a program.

Dial

The Dial is used to select programs and to change the setting of a selected parameter.

Trig button

Use the Trig button to trigger a selected channel from the unit itself. Hold Shift and the Trig button to be able to adjust the Trig button's velocity level with the Dial.

Parameter buttons



The parameters are accessed with the row of eight buttons. Edit mode is activated as soon as you press one of these buttons.

If a button activates a parameter in the upper row, a quick double-tap on the same button or by pressing the Row Select button will move the edit focus to the lower row parameters.

Hold down a button and turn the Dial to edit a red parameter.

Noise Parameters

There are several types of noise to choose from. The noise filter and sweep parameters can be used to sculpt the sound of the noise.

Color

Use the Color parameter to change the sound of the Noise. Values below 0 will have more bass content, values above 0 will have less.

Range: -10 - 10

Filter/Type

The Noise Filter is a Low Pass filter, it allows you to control how much of the high frequency noise to be filtered out of the sound. The lower you set the value, the duller the noise will become.

The second parameter is the Filter Type. There are 7 different types, each with an increasing amount of resonance that gives the filter a different sound quality. The Type setting is changed by holding the button, while turning the dial.

Filter Range: 0 - 99. Range Type: 1 - 7

Sweep/Time

The Sweep/Time parameters opens up the noise filter a bit with an envelope when you trigger the sound. The Sweep parameter sets how much the filter should be opened up and it is velocity sensitive.

The Time parameter sets the duration of the envelope. The Time setting is proportional to the Decay (see below) and is changed by holding the button, while turning the dial. A setting of 9 makes this envelope have the same duration as the Decay.

Range Sweep: 0 - 10. Range Time: 0 - 9



Decay/Gate

The Decay parameter allows you to set the length of the Noise. A higher value means a longer noise.

The Gate parameter controls if the noise should gradually decay (the “n” setting), have a “soft knee” characteristic (“S”) or decay very rapidly (“G”). The Gate parameter is changed by holding the button, while turning the dial.

Range Decay: 0 - 50. Range Gate: n, S, G

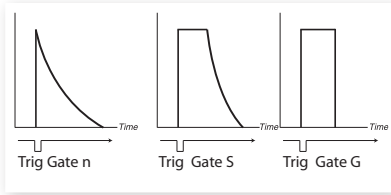

Mixer Parameters

Use the Mixer parameters to mix the separate noise, click and tone levels. The channel level sets the overall output of the sound.



Tone, Noise, Click

These parameter set the level of the individual Tone components in the channel.

Ranges: 0 - 10

Channel Level

This sets the overall loudness of the selected channel.

Range: 0 - 99

Tone Parameters

The Tone component can be described as the body of the sound. Start by selecting a waveform and then use the other parameters to get the tone as you want it.



Wave

There are several different waveforms in the Nord Drum, each with its own characteristic. Some have distinctive pitches, others are of a more metallic variety. “An” are analog waves, “b” have a drum-like personality and the “c” waves are “percussive”.

Range: An 1-3, b 1-9, c 1-5

Filter/Punch

The filter is a lowpass filter that can make the Tone duller. A setting of 99 is a fully opened filter, 0 is a closed filter.

Punch adds an short, velocity controlled attack portion to the waveform.

Range Filter: 0 - 99. Range Punch: 0 - 9

Sweep/Time

The Sweep/Time parameters open up the Tone filter a bit with an envelope when you trigger the sound. The Sweep parameter sets how much the filter should be opened up and it is velocity sensitive.

The Time parameter sets the duration of the envelope. The Time setting is proportional to the Decay (see below) and is changed by holding the button, while turning the dial. A setting of 9 makes this envelope have the same duration as the Decay.

Range Sweep: 0 - 10. Range Time: 0 - 9

Decay/Gate

The Decay sets the length of the Tone. The higher the value, the longer the sound.

The Gate parameter controls if the tone should gradually decay (the “n” setting), have a “soft knee” characteristic (“S”) or decay very rapidly (“G”). See the illustration on page 12. The Gate parameter is changed by holding the button, while turning the dial.

Range Decay: 0 - 50. Range Gate: n, S, G

Pitch

Use the pitch control to set the pitch of the Tone. The pitch is set in half steps of semitones and shown in the LED as MIDI Note Numbers. A setting of 69.0 equals A = 440 hz.

Range: 11.0 - 98.5

Bend Range/Bend Time

The Bend parameter bends the pitch of the Tone. The Bend has two directions – a negative value bends up, a positive values bends down. The amount of Bend is set with the first parameter, this is feature is also velocity sensitive.

The Bend Time parameter sets the duration of the bend. The Time setting is proportional to the Tone Decay and is changed by holding the button, while turning the dial. A setting of 9 makes this envelope have the same duration as the Decay.

Range Bend: -9 / 30. Bend Time: 0 - 9

Click Parameters

The Click is a sharp transient at the very beginning of a sound.

Type

There are several different Click types in the Nord Drum, each with a different characteristic. The n-clicks are noise waveforms with different characters, the c-clicks are still made from noise but with an

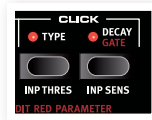

added attack. The t-clicks are more of a pitched variety.

Range: n1 - n9, c1 - c9, t1 - t9

Decay/Gate

The Decay sets the length of the Click. The higher the value, the longer the sound.

The Gate parameter controls if the noise should gradually decay (the “n” setting), have a “soft knee” characteristic (“S”) or decay very rapidly (“G”). See the illustration on page 12. The Gate parameter is changed by holding the button, while turning the dial.

Range Decay: 0 - 20. Range Gate: n, S, G

Shift Parameters

The second row has an additional set of parameters that are accessed by holding the Shift button while pressing the corresponding button.



The first two of these parameters are immediate actions (Copy and Paste), the rest are Global settings and features.

☼ *The System settings will remain in the unit after it has been turned off with one exception. Local will always revert to On when the unit is turned on..*

Copy

This function allows you to copy all the settings of the selected channel. The copy can be pasted to another channel in the same program or to a channel in another program of your choice by using Paste. The copied settings will remain in a memory buffer until you perform another copy or turn the unit off.

Paste

After you have copied a channel, and selected another program and/or channel as a destination, use this function to paste the settings. The same copied settings can be pasted to several destinations, one at a time if you wish.

Prog Dump

The Prog Dump button has three functions, Memory Protect, Dump One and Dump All. These are accessed by repeatedly pressing the Prog Dump button.

Memory Protect is set to On when the Nord Drum leaves to factory to protect the programs in the memory from being accidentally overwritten.

Dump One allows you to dump the current program from the Nord Drum as MIDI Sys Ex data. Use this to create safety copies of your individual programs or to share them with other Nord Drum users. The transmission is activated by pressing the Program button when "ONE" is shown in the display.

Dump All transmits all the 99 programs in the Nord Drum memory as MIDI Sys Ex data. The transmission is activated by pressing the Program button when "ALL" is shown in the display.

The transmission and receiving operations are described in the MIDI Operation chapter on page 15.

MIDI Ch

The MIDI Ch button has three functions. MIDI Channel, Local On/Off and Program Change Receive On/Off. These are accessed by repeatedly pressing the MIDI Ch button.

MIDI Channel: Set the Nord Drum to receive MIDI on a MIDI channel of your choice. The last entry is the Learn feature, when incoming MIDI data will determine which MIDI channel the Nord Drum should respond to.

Range: 1 - 16, Off, L r n

Local On/Off is indicated as L On or L Of. Use Local Off if you use the Nord Drum in a situation where a sequencer is echoing back notes and data.

Range: L On, L Of

Program Change can be set to Off, Send only, Receive only and both Send and Receive. Set this to receive if you want to change the programs on the Nord Drum from a MIDI controller

Range: P Of, P S, P r, P Sr

MIDI Note

Each of the four channels can be manually assigned to respond to an incoming MIDI note.

MIDI Learn Mode is the last setting. When this is selected an incoming MIDI note will be automatically set to the selected channel. The received note number will be displayed in the LED.

Range: 0 - 127, L r n

Trig Type

The Trig Type buttons provide access to 2 parameters, Trig Type and Dyn Response Curve. These are accessed by repeatedly pressing the Trig Type button. T

Trig Type: The different Trig Types that allows you to match the response of the Nord Drum to the output from your pad or drum trigger.

The trigger output from different types of pads and manufacturers varies a lot. The setting of the Trig Type parameter should be matched to suit the output from the pads you use.

The Input Trig Level LEDs provides information on the trigger signals from the pads. The green LED will indicate that a trigger signal is received. The red LED will blink quickly when the trigger signal is 6 dB below the maximum and it will be lit up in a longer duration when the maximum signal is fed to the Trig Input. To optimize the dynamic

response, make sure that only your hardest strike lights up the red LED with the longer duration.

Here is a list of some of the pads and acoustic triggered drums that have been used during the development of the Nord Drum. Other pads will work, just try the different Trig Types and settings to determine which one is the best for your needs.

Trig Type	Pads, drums
Pd1	Roland rubber pads (PD8 etc.)
Pd2	Yamaha pads (TP65 etc.)
Pd3	Mesh pads
Ac1	Trigger fitted to kick, snare
Ac2	Trigger fitted to high, mid toms
Ac3	Trigger fitted to low toms

⚠ *Roland and Yamaha are trademarks of their respective owners and are not affiliated or associated with Clavia. These trademarks are mentioned here only as a reference to products that can be used with the Nord Drum*

Range: Pd1, Pd2, Pd3, Ac1, Ac2, Ac3

Dynamics: Press the Trig Type button a second time to select the dynamic setting. “Dn1” is a linear response to the velocity on the pads. Try “Dn2” if you want a “hotter” response.

Range: Dn1, Dn2

Inp Thres

Use this setting to make sure that a pad mounted on the same hardware or other input device does not accidentally trigger a channel. If striking a pad that is connected to channel 2 also triggers the sound on channel 1, raise the threshold on channel 1.

Range: 0 - 99

Inp Sens

Use this setting to match the output signal of the pad or input device connected to the Trig Input of the selected channel. Adjust this to make sure

that only your hardest strike lights up the red LED in its longer duration on the Input Trig Level LEDs.

Range: 0 - 99

MIDI Operation

The four channels of the Nord Drum are triggered by incoming MIDI Notes 36, 38, 59 and 47 when the unit is shipped from the factory.

This assignment is compatible with the General MIDI Specification for Bass drum 1, Snare drum 1, Hi tom 1 and Mid tom 1. If you prefer other notes this can be changed in the MIDI Note setting, read more on this on page 14.

Storing the memory content

By using MIDI Sys Ex dumps, you can store all or individual programs on a computer. The dumps have to be recorded to a sequencer or by using one of the many, free MIDI applications that can receive, save and also transmit MIDI data.

💡 *Windows users can do this with MIDI Ox (www.midiox.com), Mac OSX users can use the SysEx Librarian from Snoize Productions (www.snoize.com).*

① Make sure that the receiver is ready to receive and that the MIDI Out from the Nord Drum is connected to a MIDI In on a MIDI interface connected to the computer.

② Press Shift and the Prog Dump button repeatedly until ONE or ALL is shown in the display.

One means the current program, all means all the 99 programs in the Nord Drum.

③ Start the transmission by pressing the Program button. After the transmission is complete, Ok will be shown briefly in the display.

- 4 Check the receiving application and make sure that the data is there. Save the file with a meaningful name on a nice place on the hard drive.

❗ *Transmitting data will not affect the content in the Nord Drum.*

Receive MIDI Dumps

- 1 Make sure that your sequencer or MIDI application is ready to transmit a Sys Ex package and that the MIDI Out from the MIDI interface on the computer is connected to the MIDI In on the Nord Drum.
- 2 Start the transmission. The Nord Drum will automatically receive incoming MIDI Sys Ex messages that it is compatible with.

If the Sys Ex package contains all the 99 programs, the entire memory in the Nord Drum will be replaced by the content of the Sys Ex package, except for any edited program that was in the edit buffer when the transmission started.

If the Sys Ex package contains one program, this program will be placed in the edit buffer of the Nord Drum. You have to Store this program to a location in the memory, if you want to keep it in the unit.

Updating the Operating System

The OS in the Nord Drum may be updated if the functionality is subject to improvements.

This is achieved by using a MIDI transmission from a computer by using an Update Utility that can be downloaded from the www.norddrum.com web site. The Update Utility is available for Windows or Mac OSX computers, make sure you download the one that matches your computer.

You will need a MIDI interface attached to the computer in order to perform this.

- 1 Connect the MIDI in and the MIDI Out from the Nord Drum to the MIDI Out and MIDI in on the MIDI interface.
 - 2 Double click on the OS utility to run the Updater.
- ❗ *The Windows version of the utility is a zipped archive when you download it from the website. This archive has to be expanded with an application like WinRAR before the actual utility is ready to be used.*
- 3 Select the MIDI ports you wish to use.

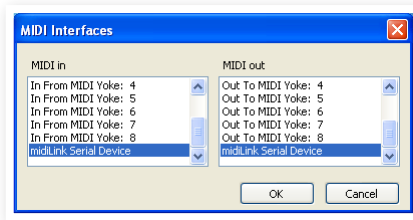

The Update Utility will display the current OS version in the connected Nord Drum.

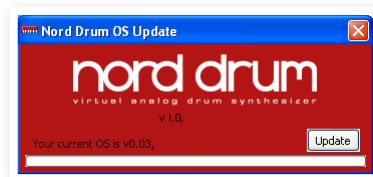

- 4 Click on the Update button to transfer the new OS to the unit.

Website

Please check in from time to time on the www.norddrum.com website for OS updates, additional programs and other things that may become available.

4 Appendix

Factory Soundbank

There are 99 Programs locations in the Nord Drum. The locations numbered P80 to P99 are empty, to allow you to immediately store your own edits without having to worry about overwriting any programs that you might have liked.

The entire memory content can be saved as a MIDI Sys Ex file on a computer, using the methods described on page 16 in this manual. A MIDI Sys Ex file that is a copy of the Factory Soundbank can be found on the www.norddrum.com website.

	Style	Name	Cat.
P1	Retro	Monologue	Drums
P2	Real	Classic Vistalite	Drums
P3	Retro	Blue House	Kit
P4	Real	Brushford	Kit
P5	Real	Bebop delux	Drums
P6	Retro	Always Hip Hop	Kit
P7	Real	Gran Casa Timp	Drums
P8	Retro	Thanx to Burgees	Drums
P9	FX	Reso Sweep	Perc
P10	Retro	Vince Gate	Drums
P11	Retro	UnoDosKickHat	Kit
P12	Real	Spectrum	Drums
P13	Real	Ateiste	Drums
P14	Retro	Noisy Barrel Orchestra	Drums
P15	Retro	Higgins Particle Hat	Kit
P16	Retro	Clothed Funk Kit	Kit
P17	Ethno	Komal Melodic	Perc
P18	Ethno	Lalalatin	Perc

P19	Retro	Bend Down Disco	Perc
P20	Retro	Flying Dront Circus	Kit
P21	Ethno	Tribunal	Perc
P22	Real	King Kong Karma	Kit
P23	FX	Training with Komal	Perc
P24	Retro	Tiny Tiny Pic	Kit
P25	Ethno	Red Beat	Perc
P26	Retro	beatPerlife	Kit
P27	Retro	Piccolosim	Perc
P28	Real	Acoustic Flower King	Kit
P29	FX	Apostasy Steam Noise	Perc
P30	FX	DoReMinor Melodic	Perc
P31	FX	Must Bend Tolotto	Drums
P32	Ethno	Sambalasalala	Perc
P33	FX	Kiss the Click	Perc
P34	Retro	Sweep Type 4tonight	Drums
P35	FX	Noise Click Trap	Kit
P36	Real	Bend Timpanic	Drums
P37	Retro	dododrum	Kit
P38	FX	Fast Sweep Melodic	Drums
P39	Ethno	Bella Balinese	Perc
P40	FX	Noisy Royalty	Drums
P41	Ethno	Steely Melodic	Drums
P42	Real	Soft Acoustic	Drums
P43	Real	Tubular Bells & Triangle	Perc
P44	Ethno	Ultra Tribal Dance	Perc
P45	Retro	HeaHihat	Kit
P46	FX	Click Gate and Vinyl	Kit
P47	Real	Double Snare	Kit
P48	Real	Hells Bells	Perc
P49	Real	Rototsthile	Drums
P50	Retro	Melodic Technocrat	Kit
P51	Real	Dull Dusty	Drums
P52	FX	Retrophile Gated Noise	Drums

P53	Ethno	Real Cuba Conga Cola	Perc
P54	Retro	Retrograd	Drums
P55	FX	GasaGate	Perc
P56	Real	Clap Trap	Drums
P57	Real	Krimsonite	Drums
P58	Real	Serious Decay	Kit
P59	Ethno	Dry Tribe	Drums
P60	FX	Cinematikino	Perc
P61	FX	Toy Ambulance	Kit
P62	Retro	Neophile	Drums
P63	Retro	Stabby Hip Hop	Kit
P64	Real	Retro Noise Reverb	Drums
P65	Retro	Ulam Spiral	Drums
P66	Retro	Sawkas Jungle Heat	Kit
P67	Retro	Knick Knock Knack	Drums
P68	Real	Bright Click Brush	Drums
P69	Retro	New Romantic Tight	Kit
P70	FX	Intergalactic Battle	Perc
P71	Retro	Nosampled Drum	Drums
P72	Retro	Poor Tone	Kit
P73	FX	Clicks&Pops	Drums
P74	FX	Fat Gated Chattanooga	Drums
P75	Real	RetroReal Snap Snare	Drums
P76	Ethno	Slitz Box	Perc
P77	Ethno	Real Tommy Steel	Perc
P78	FX	Macro Sweeper	Kit
P79	FX	Darwins Sex Machine	Kit
P80	Real	Apparatorium	Drums
P81			
P82			
P83			
P84			
P85			
P86			
P87			
P88			
P89			
P90			

P91			
P92			
P93			
P94			
P95			
P96			
P97			
P98			
P99			

Styles

Real: “Acoustic”.

Retro: Machine or old school sounds.

Ethno: World Music

FX: Weird tweaks and FX.

Categories

Drums: Kick, Snare, Tom1 Tom2. Use these together with acoustic hi-hat & cymbals

Percussion: Made for 4 pads, for the standup percussionist.

Kit: Kick, Snare, Tom, Hi-hat. Use these with a sequencer application.

FCC Information (U.S.A.)

1. IMPORTANT NOTICE: DO NOT MODIFY THIS UNIT!

This product, when installed as indicated in the instructions contained in this manual, meets FCC requirements. Modifications not expressly approved by Clavia may void your authority, granted by the FCC, to use the product.

2. IMPORTANT: When connecting this product to accessories and/ or another product use only high quality shielded cables. Cable/s supplied with this product **MUST** be used. Follow all installation instructions. Failure to follow instructions could void your FCC authorization to use this product in the USA.

3. Note: This equipment has been tested and found to comply with the limits for a Class B digital device, pursuant to Part 15 of the FCC Rules. These limits are designed to provide reasonable protection against harmful interference in a residential installation. This equipment generates, uses, and can radiate radio frequency energy and, if not installed and used in accordance with the instructions, may cause harmful interference to radio communications. However, there is no guarantee that interference will not occur in a particular installation. If this equipment is found to be the source of interference to radio or television reception, which can be determined by turning the equipment off and on, the user is encouraged to try to correct the interference by one or more of the following measures:

- Reorient or relocate the receiving antenna.
- Increase the separation between the equipment and receiver.
- Connect the equipment into an outlet on a circuit different from that to which the receiver is connected.
- Consult the dealer or an experienced radio/TV technician for help.

This device complies with Part 15 of the FCC Rules. Operation is subject to the following two conditions:

- (1) this device may not cause harmful interference, and
- (2) this device must accept any interference received, including interference that may cause undesired operation.

Unauthorized changes or modification to this system can void the users authority to operate this equipment.

This equipment requires shielded interface cables in order to meet FCC class B Limit.

For Canada

NOTICE

This Class B digital apparatus meets all requirements of the Canadian Interference-Causing Equipment Regulations.

AVIS

Cet appareil numérique de la classe B respecte toutes les exigences du Règlement sur le matériel brouilleur du Canada.

DECLARATION OF CONFORMITY Compliance Information Statement

Model Name : Nord Drum

Type of Equipment : Digital Drum unit

Responsible Party :Clavia DMI AB

Address : P.O. BOX 4214. SE-102 65 Stockholm Sweden

Telephone : +46-8-442 73 60

