

**nord lead 3 nord rack 3**  
performance synthesizer performance synthesizer



Part No. 2700,2101

# **OWNER'S MANUAL**

**SOFTWARE VERSION 1.2x**

BY CLAVIA DMI AB

 <p style="margin: 0;"><b>CAUTION AVIS</b></p> <p style="margin: 0;">RISK OF ELECTRIC SHOCK DO NOT OPEN</p> <p style="margin: 0;"><i>RISQUE DE SHOCK ELECTRIQUE NE PAS OUVRIR</i></p> 
<p><b>CAUTION: TO REDUCE THE RISK OF ELECTRIC SHOCK DO NOT REMOVE COVER (OR BACK). NO USER SERVICEABLE PARTS INSIDE. REFER SERVICING TO QUALIFIED PERSONNEL.</b></p> <p><i>ATTENTION: POUR EVITER LES RISQUES DE CHOC ELECTRIQUE, NE PAS ENLEVER LE COUVERCLE. AUCUN ENTRETIEN DE PIECES INTERIEURES PAR L'USAGER. CONFIER L'ENTRETIEN AU PERSONNEL QUALIFE. AVIS: POUR EVITER LES RISQUES D'INCIDENTE OU D'ELECTROCUTION, N'EXPOSEZ PAS CET ARTICLE A LA PLUIE OU L'HUMIDITET.</i></p>



The lightning flash with the arrowhead symbol within an equilateral triangle is intended to alert the user to the presence of uninsulated voltage within the products enclosure that may be of sufficient magnitude to constitute a risk of electric shock to persons.

*Le symbole éclair avec le point de flèche à l'intérieur d'un triangle équilatéral est utilisé pour alerter l'utilisateur de la présence à l'intérieur du coffret de "voltage dangereux" non isolé d'ampleur suffisante pour constituer un risque d'électrocution.*

The exclamation mark within an equilateral triangle is intended to alert the user to the presence of important operating and maintenance (servicing) instructions in the literature accompanying the product.



*Le point d'exclamation à l'intérieur d'un triangle équilatéral est employé pour alerter l'utilisateur de la présence d'instructions importantes pour le fonctionnement et l'entretien (service) dans le livret d'instructions accompagnant l'appareil.*

Instructions pertaining to a risk of fire, electric shock or injury to persons.

## IMPORTANT SAFETY INSTRUCTIONS

### SAVE THESE INSTRUCTIONS

Warning - When using electric products, basic precautions should always be followed, including the following:

1. Read all the instructions and observe the graphic symbols above before using the product.
2. Do not use this product near water - for example near a bathtub, washbowl, kitchen sink, in a wet basement, near or in a swimming pool, a swamp or the like.
3. This product should be used only with a cart or a stand that is recommended by the manufacturer.
4. This product, either alone or in combination with an amplifier and headphones or speakers may be perfectly capable of producing sound levels that could cause permanent hearing loss. Do not operate for a long period of time at a high volume level or at a level that is uncomfortable. If you experience any hearing loss or ringing in the ears, you should consult an audiologist.
5. The product should be located so that its location or position does not interfere with or obstruct its normal flow of ventilation.
6. The product should be located away from heat sources such as radiators, heat registers or other products that produce heat.
7. The product should be connected to a power supply only of the type described in these operation instructions or as marked on the product.
8. The power supply cord of the product should be unplugged from the outlet when the product is left unused for a long period of time.
9. Care should be taken so that objects do not fall, or liquids are not spilled into the enclosure through openings.
10. The product should be serviced by qualified service personnel when:
  - A. The power supply cord has been damaged; or
  - B. Objects have fallen or liquids have been spilled onto the product; or
  - C. The product has been exposed to rain; or
  - D. The product does not appear to operate normally or exhibits a marked change in performance; or
  - E. The product has been dropped or the enclosure has been damaged.
11. Do not attempt to service the product beyond those means described in this operating manual. All other servicing should be referred to qualified service personnel.

**Trademarks:** The Nord Lead logo is registered trademark of Clavia DMI AB. All other trademarks mentioned in this publication are the properties of their respective holders.

Specifications and appearances are subject to change without notice.

Copyright by Clavia DMI AB, 2001



## TABLE OF CONTENTS

<b>1. INTRODUCTION .....</b>	<b>7</b>
<b>WELCOME .....</b>	<b>7</b>
<b>ABOUT THIS MANUAL .....</b>	<b>7</b>
Reading the manual in Adobe Acrobat Reader.....	7
<b>CLAVIA ON THE INTERNET .....</b>	<b>7</b>
<b>2. OVERVIEW .....</b>	<b>8</b>
<b>NORD LEAD 3 AND RACK 3 FRONT PANELS.....</b>	<b>8</b>
Left (Top) panel section.....	8
Right (bottom) panel section .....	9
<b>NORD LEAD 3 AND RACK 3 REAR PANEL.....</b>	<b>9</b>
Connections .....	10
Connecting pedals .....	10
<b>NORD LEAD 3 BLOCK DIAGRAM .....</b>	<b>11</b>
<b>ADVANCED SUBTRACTIVE SYNTHESIS.....</b>	<b>11</b>
<b>3. GETTING STARTED .....</b>	<b>12</b>
<b>BASIC MIDI SETTINGS .....</b>	<b>12</b>
Note Trig (Nord Rack 3).....	13
<b>SELECTING PROGRAMS .....</b>	<b>13</b>
<b>USING THE SLOTS .....</b>	<b>13</b>
<b>LAYERING .....</b>	<b>14</b>
Activating Slots.....	14
Deactivating Slots.....	14
Polyphony .....	14
Replacing a Program in the layer.....	14
<b>KEYBOARD SPLIT .....</b>	<b>15</b>
Setting the Split Point.....	15
Combining Split and Layer.....	16
<b>PERFORMANCES .....</b>	<b>17</b>
<b>ALTERNATING BETWEEN PROGRAM MODE AND PERFORMANCE MODE</b>	<b>17</b>
<b>POLYPHONIC AND MONOPHONIC OPERATION .....</b>	<b>17</b>
Unison.....	18
<b>PITCH STICK AND MODULATION WHEEL .....</b>	<b>18</b>
Pitch Stick (Nord Lead 3 only) .....	18
Pitch Bend range settings.....	18
Modulation Wheel and Mod Wheel MIDI data .....	19
Master Tune.....	19
<b>USING A SUSTAIN PEDAL .....</b>	<b>20</b>
<b>USING A CONTROL (EXPRESSION) PEDAL.....</b>	<b>20</b>
<b>THE ‘PANIC’ BUTTON.....</b>	<b>20</b>

<b>4. EDITING PROGRAMS .....</b>	<b>21</b>
<b>EDITING A PROGRAM .....</b>	<b>21</b>
The knobs with circular LED graphs .....	21
The buttons .....	22
<b>EDITING A PROGRAM IN A LAYER.....</b>	<b>22</b>
<b>REVERTING TO THE ORIGINAL PROGRAM.....</b>	<b>22</b>
<b>USING ‘SOUND INIT’ AND ‘FM INIT’ .....</b>	<b>22</b>
<b>MUTING PARAMETER SECTIONS .....</b>	<b>23</b>
<b>STORING A PROGRAM .....</b>	<b>23</b>
Storing without changing the Program name.....	24
Storing with the possibility to select Category and/or change the Program name .....	24
<b>SEARCHING FOR AND LOADING PROGRAMS.....</b>	<b>26</b>
Search for a Program in a specific Category.....	26
Search for a Program in alphabetical order .....	27
<b>COPYING PROGRAMS .....</b>	<b>27</b>
From one memory location to another.....	27
From one Slot to another .....	28
<b>DELETING PROGRAMS .....</b>	<b>28</b>
<b>DOWNLOADING PROGRAMS VIA MIDI.....</b>	<b>28</b>
<b>5. MORPH GROUPS .....</b>	<b>29</b>
<b>ASSIGN PARAMETERS TO A MORPH GROUP.....</b>	<b>29</b>
<b>DEASSIGN PARAMETERS FROM A MORPH GROUP .....</b>	<b>31</b>
<b>COPY A MORPH GROUP TO ANOTHER SOURCE.....</b>	<b>31</b>
<b>A WORD ABOUT KEYBOARD MORPH.....</b>	<b>31</b>
<b>A WORD ABOUT CONTROL PEDAL MORPH.....</b>	<b>31</b>
<b>MORPHING CLOCK-SYNCHED PARAMETERS .....</b>	<b>31</b>
<b>6. PERFORMANCES .....</b>	<b>32</b>
<b>WHAT IS A PERFORMANCE? .....</b>	<b>32</b>
<b>RECALLING A PERFORMANCE.....</b>	<b>32</b>
<b>CREATING A PERFORMANCE .....</b>	<b>33</b>
Selecting Programs for the Slots.....	33
Editing.....	33
Solo single sounds in a Performance.....	33
Keyboard Split.....	34
<b>STORING A PERFORMANCE.....</b>	<b>36</b>
Storing without changing the name .....	36
Storing with the possibility to change the name .....	36
Naming single sounds in Performances.....	38
<b>EXTRACTING SINGLE SOUNDS FROM A PERFORMANCE.....</b>	<b>39</b>
Extract a sound and save it as a Program .....	39
Extract a sound, rename it and save it as a Program .....	39
<b>DELETING PERFORMANCES .....</b>	<b>40</b>

<b>EXITING PERFORMANCE MODE.....</b>	<b>40</b>
<b>WHAT A PERFORMANCE CONTAINS.....</b>	<b>41</b>
For each Slot.....	41
For the entire instrument.....	41
<b>DOWNLOADING PERFORMANCES VIA MIDI.....</b>	<b>41</b>
<b>7. PANEL REFERENCE.....</b>	<b>42</b>
<b>LFO 1 &amp; 2.....</b>	<b>42</b>
Rate.....	42
Waveform.....	44
Destination.....	45
Amount.....	46
Env/KB snc.....	46
Mono.....	46
LFO behavior in Mono mode.....	46
LFO modulation table.....	48
<b>MODULATION ENVELOPE.....</b>	<b>49</b>
Attack.....	49
Decay/Release.....	49
Destination.....	50
Amount.....	51
Repeat.....	52
Mod Envelope modulation table.....	52
<b>OSCILLATOR 1 &amp; 2.....</b>	<b>53</b>
Waveform selector, Shape and Sync.....	53
Oscillator Sync.....	60
<b>OSCILLATOR 2.....</b>	<b>63</b>
Waveform selector, Shape and Sync.....	63
KBT off.....	66
Fine tune.....	67
Coarse tune.....	67
The Pitch LED Display.....	67
<b>OSCILLATOR MODULATION.....</b>	<b>70</b>
Modulation amount.....	70
Mode.....	70
<b>OSCILLATOR MIXER.....</b>	<b>77</b>
Osc Mix.....	77
Oscillator Mixer Noise (Noise3).....	77
<b>AMPLIFIER ENVELOPE.....</b>	<b>78</b>
Attack.....	79
Decay.....	79
Sustain.....	80
Release.....	80
ADSR Envelope behavior.....	80
<b>OUTPUT LEVEL.....</b>	<b>81</b>
<b>FILTER OVERVIEW.....</b>	<b>82</b>

<b>FILTER ENVELOPE .....</b>	<b>82</b>
Attack.....	83
Decay.....	83
Sustain .....	83
Release .....	83
Velocity, EnvAmt and Invert .....	83
<b>SINGLE FILTER MODES .....</b>	<b>84</b>
Frequency1 .....	85
Filter slope (roll-off).....	85
Resonance.....	85
Filter type .....	87
KB Track.....	89
<b>MULTI FILTER MODES .....</b>	<b>90</b>
Freq2/Dist .....	90
Multi Filter type .....	91
Osc2Byp/Noise3 only.....	96
Filt.Env.....	96
<b>THE LEFT (TOP) PANEL SECTION .....</b>	<b>97</b>
Arpeggio .....	97
Vibrato .....	105
Glide (portamento) .....	106
Voice mode.....	106
Polyphonic Legato with polyphonic Glide .....	108
Unison.....	109
Keyboard Split.....	110
Octave Shift.....	111
Note Trig (Nord Rack 3).....	112
Chord Memory.....	112
Stack.....	113
KB Hold.....	114
Panic.....	115
Pitch Stick (Nord Lead 3).....	115
Pitch bend range.....	115
Modulation Wheel.....	116
Active Device.....	116
<b>MENU FUNCTIONS.....</b>	<b>117</b>
Master Clock .....	117
MIDI.....	119
Dump One.....	122
Synth .....	123
FM Init.....	129
Sound .....	130
Sound Init .....	132
<b>USEFUL FUNCTIONS.....</b>	<b>133</b>
Monitor .....	133
Copy & Paste.....	133
Mute.....	134
Special information in the Display .....	135

<b>8. FACTORY PRESETS AND OS.....</b>	<b>137</b>
<b>FLASH MEMORY.....</b>	<b>137</b>
<b>FACTORY PRESETS.....</b>	<b>137</b>
Restoring the factory presets .....	137
<b>OS UPGRADES.....</b>	<b>137</b>
<b>9. BASIC MIDI FUNCTIONS.....</b>	<b>138</b>
<b>ABOUT THE MIDI IMPLEMENTATION .....</b>	<b>138</b>
Note On/Off.....	138
Pitch Bend.....	138
Controllers.....	138
Aftertouch .....	138
Program Change.....	139
Bank Select .....	139
MIDI SysEx (System Exclusive).....	139
<b>USING NORD LEAD 3 WITH A SEQUENCER .....</b>	<b>139</b>
Connections .....	139
Local On/Off.....	139
MIDI channels .....	140
Program Change & Bank Select.....	140
Controllers.....	140
MIDI Clock .....	141
Some notes about Controllers and “Chasing” .....	141
<b>PROGRAM/PERFORMANCE SYSEX DUMPS .....</b>	<b>141</b>
Send a single Program/Performance Dump .....	141
Send a Bank Dump .....	142
Receive a Bulk Dump .....	142
<b>10. MIDI IMPLEMENTATION.....</b>	<b>143</b>
<b>MIDI CONTROLLER LIST .....</b>	<b>143</b>
<b>SYSTEM EXCLUSIVE IMPLEMENTATION .....</b>	<b>147</b>
General Message format.....	147
Program Dumps .....	147
Patch (Program) Dump Request.....	150
Performance Dump .....	151
Performance Dump Request.....	154
All Controllers Request (Message Type \$40) .....	155
Program and Performance data formats .....	155
Patch (Program) dump format.....	156
Morph group parameter list.....	158
Performance data format.....	159
<b>MIDI IMPLEMENTATION CHART.....</b>	<b>160</b>
<b>INDEX.....</b>	<b>161</b>





# 1. INTRODUCTION

## WELCOME

We'd first like to thank you for purchasing the Nord Lead 3/Nord Rack 3 Advanced Subtractive Performance Synthesizer. Nord Lead 3 is the third generation of the Nord Lead series. With the first Nord Lead back in 1995, Clavia introduced the 'Virtual Analog' concept: analog synthesis emulated in real-time by digital signal processors. With Nord Lead 3 'Virtual Analog' is not a correct definition anymore - it can do so much more. The Nord Lead 3 sound engine offers a combination of traditional shapable analog waveforms and an extremely user-friendly 2 or 4 operator FM engine. It's about all you need to create most types of electronic sounds. Add to this the new adjustable Unison to beef up the sound without reducing the poly-phony. But not all the magic lies in the sound generation. A major part is in the front panel. With Nord Lead 3 Clavia introduces the industry's most user-friendly and intuitive user interface. Rotary encoders combined with circular LED graphs give you total and immediate control. Creating and editing sounds has never been easier. With Nord Lead 3 the 'Virtual Analog' synthesizer steps up to the next level. Welcome to the 'Advanced Subtractive Performance Synthesizer'.

## ABOUT THIS MANUAL

If you have some basic knowledge about programmable analog synthesizers, you probably won't need this manual much. If you don't have that much experience of synthesis, there are detailed descriptions and graphs explaining the theoretics behind the different "modules" of the Nord Lead 3. The manual is arranged mainly as a reference manual describing all the functions of Nord Lead 3. In many cases you'll get tips on how to practically use the functions, alone and also together with other functions. Every function described in this manual also applies to the rack version of Nord Lead 3, the Nord Rack 3, unless otherwise is stated.

Every time this manual wants your attention to an object on the synthesizer, the name of that object will be printed LIKE THIS, e.g. 'click on the STORE button'. The backlit LCD on Nord Lead 3 is always referred to as the DISPLAY. Whenever there is a reference to the 'keyboard', that reference will also apply to any incoming MIDI notes to the Nord Lead 3 instrument.

## READING THE MANUAL IN ADOBE ACROBAT READER

This manual is also available in the digital PDF-file format. It can be downloaded, free of charge, from Clavia's web site at <http://www.clavia.se>. When reading the manual as PDF-file, you will need Adobe Acrobat Reader 4.0 or later. This program can be downloaded, free of charge, at <http://www.adobe.com>. With Adobe Acrobat Reader it is possible to use special navigation features like hyperlinks. This means that you can click with the mouse on a word or sentence and automatically get to the location indicated by the word/sentence. To better show what words or sentences are hyperlinked in this manual, these words are written in magenta.

## CLAVIA ON THE INTERNET

If you have access to the Internet, you're very welcome to visit <http://www.clavia.se>. There you will find the latest information about Nord Lead 3 and other Clavia products. In the future you'll also be able to download new Nord Lead 3 sounds and software upgrades, free of charge.

# 2. OVERVIEW

## NORD LEAD 3 AND RACK 3 FRONT PANELS

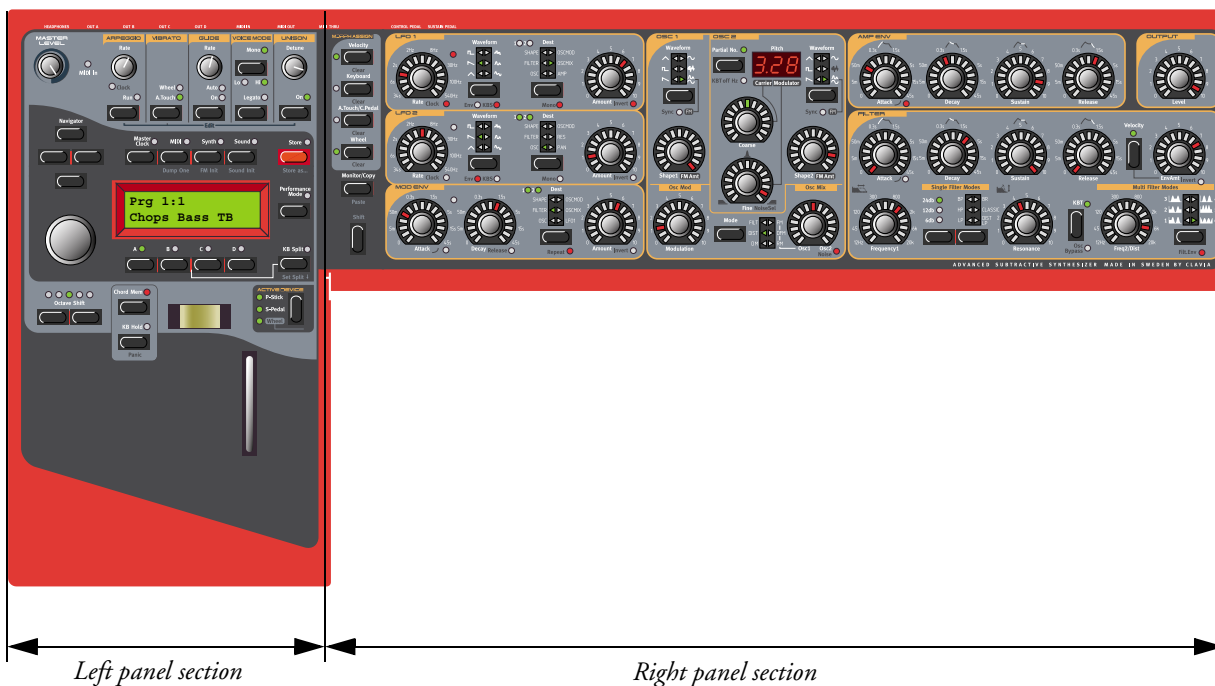

### LEFT (TOP) PANEL SECTION

#### MASTER LEVEL

The MASTER LEVEL knob controls the output level of all four OUT jacks and the HEADPHONES output. The MASTER LEVEL knob does not send or receive any MIDI CC# but is used to control the entire instrument's output level. (For info on how to control the level(s) of the individual sounds and via MIDI, please refer to "Output Level" on page 81).

**NAVIGATOR BUTTONS, ROTARY DIAL AND DISPLAY**

Below the MASTER LEVEL knob is a set of four buttons, the NAVIGATOR buttons. These are used to navigate in the DISPLAY and to select different functions. Below the NAVIGATOR buttons is the ROTARY DIAL. With the ROTARY DIAL you can select sounds, enter various kind of data etc.

**SLOT BUTTONS**

Below the DISPLAY are the four SLOT buttons (A, B, C and D). You can load one sound in each of the Slots at a time.

**PERFORMANCE CONTROLS**

Below the DISPLAY section you find various performance controls, such as the PITCH STICK (not Nord Rack 3), MOD WHEEL (not Nord Rack 3), CHORD MEMORY, HOLD and ACTIVE DEVICE.

**RIGHT (BOTTOM) PANEL SECTION****MORPH ASSIGN BUTTONS**

The four MORPH ASSIGN buttons are used when you want to control several parameters in a sound from single control sources.

**THE SHIFT BUTTON**

Below the MORPH ASSIGN buttons is the SHIFT button. It's used to alternate parameter functions and also to activate various other functions.

**SOUND PARAMETERS**

All parameters (knobs and buttons) surrounded by yellow frames are used for creating and controlling sounds. Here you also find the new type of intuitive knobs combined with circular LED graphs that make creating and editing sounds extremely easy.

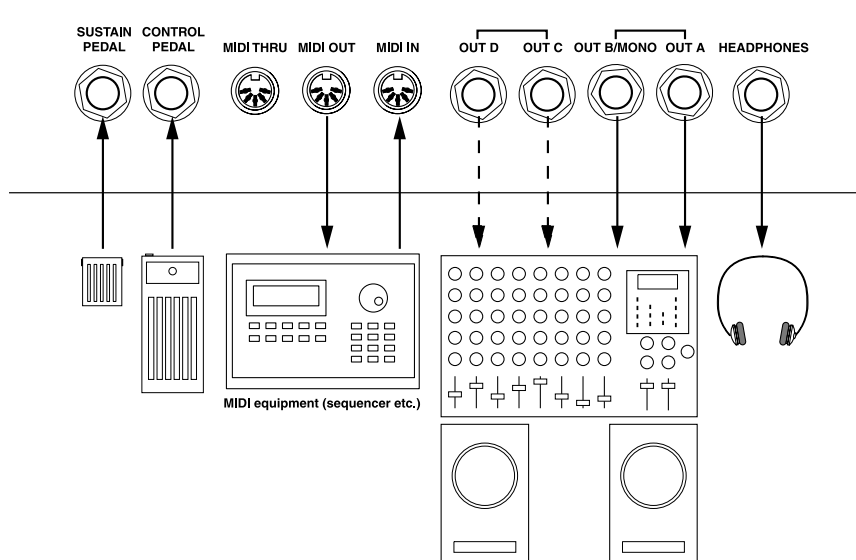
**NORD LEAD 3 AND RACK 3 REAR PANEL**

## CONNECTIONS

- Make all connections before turning on your power amplifier!
- If you are using a Nord Lead 3 together with a MIDI keyboard, connect a MIDI cable from MIDI Out on the keyboard to MIDI IN on the Nord Lead 3.
- All signal cables used with the Nord Lead 3 must be shielded.
- All four mono outputs (OUT A, OUT B, OUT C, OUT D) are line level and unbalanced. If you want the sum of the signals on one separate output only, use OUT B.
- If you connect the Nord Lead 3 in stereo to your audio equipment, you should use OUT A in pair with OUT B or OUT C in pair with OUT D.

## CONNECTING PEDALS

The Nord Lead 3 has two pedal inputs, one for a sustain pedal and one for a control pedal (an expression-type pedal, used to control various parameters). Connect the pedals as shown in the figure below:

- When connecting an expression-type pedal to the Control Pedal input, you should use a stereo cable (Tip-Ring-Sleeve). Please note that the pedal must have a stereo output jack. The resistance range of the Control Pedal should be 10 kOhm to 50 kOhm.

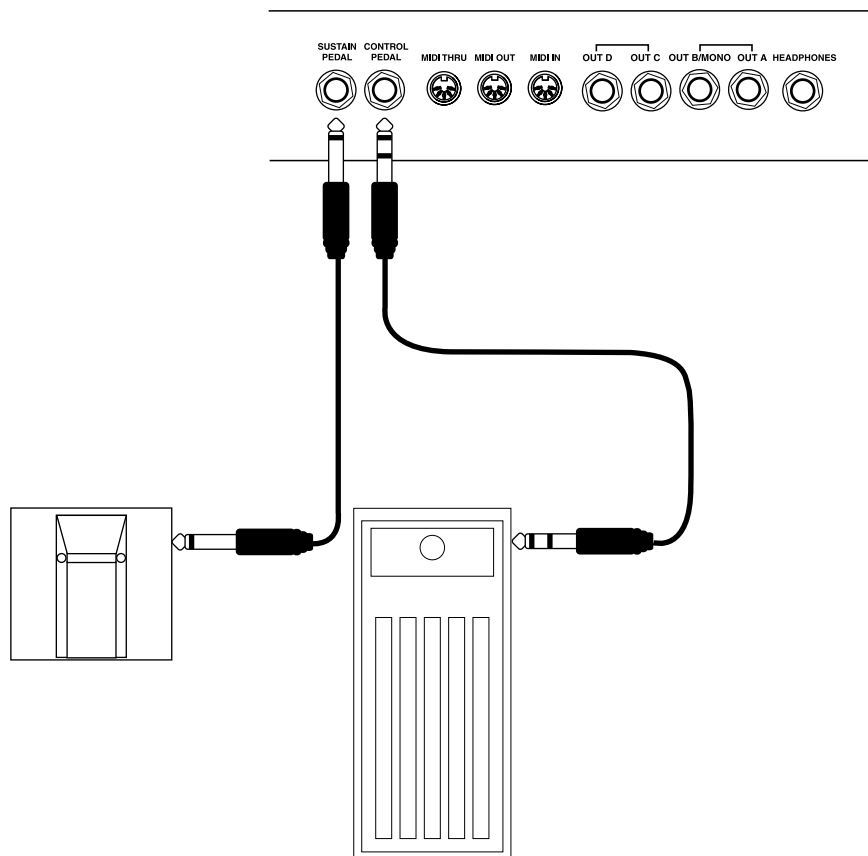

(For more detailed information on how to set up Nord Lead 3 for use with sustain and expression pedals, see [page 20](#)).

## NORD LEAD 3 BLOCK DIAGRAM

Below is a schematic overview of the sound and modulation building blocks and the signal flows in Nord Lead 3. The filled lines indicate audio signal routings and the dashed lines control signal routings. The diagram does not include the routing possibilities for the Morph Groups. The Morph function lets you control up to 26 parameters from four separate control sources (4 x 26 parameters). There would be too many lines in the diagram if all possible Morph routings were to be shown.

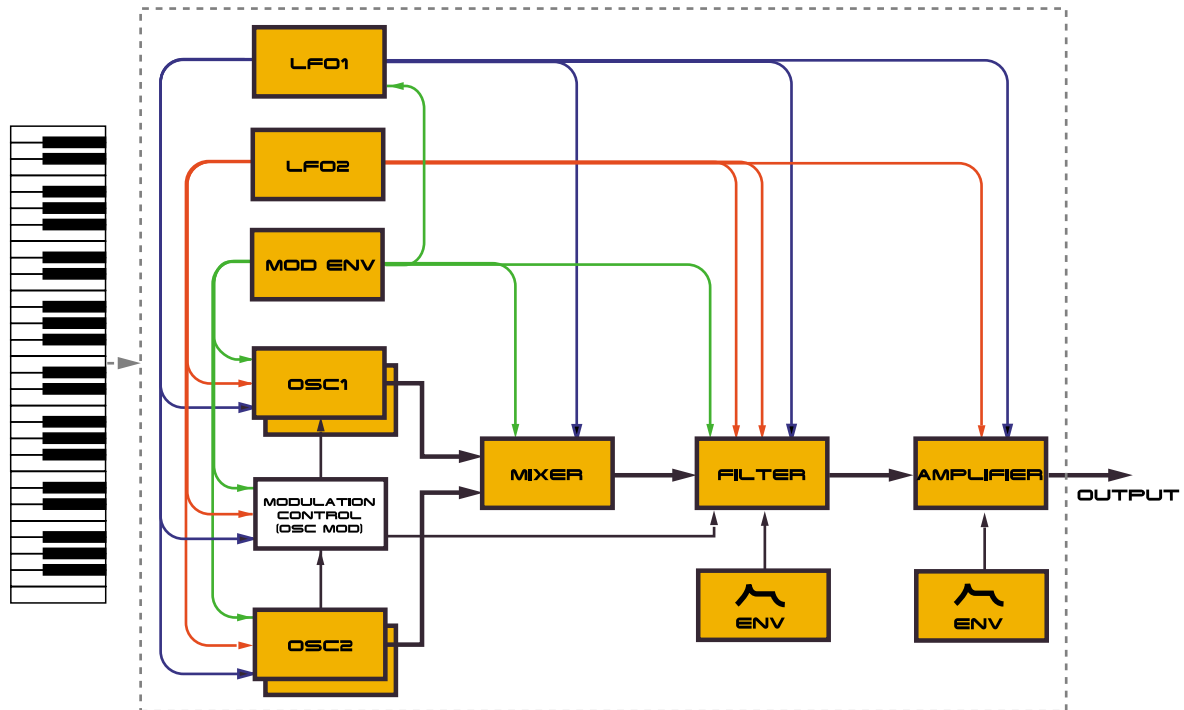

As you can see, Nord lead 3 offers vast control and modulation possibilities. Each of the building blocks also has extensive possibilities for internal configurations. This is described in detail in [Chapter "7. Panel reference" on page 42.](#)

## ADVANCED SUBTRACTIVE SYNTHESIS

Nord Lead 3 is the first “hard-wired” synthesizer to employ what Clavia call ‘Advanced Subtractive Synthesis’. The philosophy behind Advanced Subtractive Synthesis is to offer a flexible sound engine that features both traditional “subtractive” waveforms and powerful and extremely user-friendly FM synthesis. Each oscillator offers six different shapable waveforms to choose among. These waveforms can also be synced using the additional sync oscillator of each oscillator group. The big advantage of having an extra sync oscillator is that you don’t need to sacrifice an audio oscillator just to sync another. In other words, you will always have at least two audio oscillators per voice even when using oscillator sync! The FM mode of the oscillators is called ‘Dual Sine FM’. In this mode each oscillator forms a 2-operator FM engine, for a total of 4 operators per voice. The oscillator section also boosts a number of exciting modulation possibilities, including the new Distortion Modulation and Filter FM. No matter what mode the oscillators are in, you are always able to route their signals through the high-quality multi filter for further shaping. This is what we mean by Advanced Subtractive Synthesis.

# 3. GETTING STARTED

## BASIC MIDI SETTINGS

If you are controlling the Nord Lead 3 from an external MIDI keyboard, the Nord Lead 3 must be set to receive on the same MIDI channel that the MIDI keyboard transmits on.

1. Set the MIDI keyboard to transmit and receive on MIDI Channel 1. (This is the default setting when Nord Lead 3 is shipped from factory).
2. Press the **MIDI** button and the **UP/DOWN NAVIGATOR** button until the **DISPLAY** reads:



3. Scroll with the **ROTARY DIAL** to select MIDI Channel 1 for Slot A.
4. Select MIDI Channels for the other three Slots by pressing the respective **SLOT** button and scrolling with the **ROTARY DIAL**. Select, for example, MIDI Channel 2 for Slot B, 3 for Slot C and 4 for Slot D.
5. Press the **MIDI** button to exit.

If you use Slot A when you play the Nord Lead 3 (if you like, together with other Slots), this basic setting should be sufficient in most situations - also when playing Layers and Performances, as described later in this manual. For information on how to set up Nord Lead 3 for use with an external sequencer, see [“Using Nord Lead 3 with a sequencer” on page 139](#).

## NOTE TRIG (NORD RACK 3)

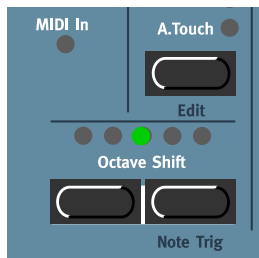

If you shouldn't have a MIDI keyboard connected to your Nord Rack 3 it can sometimes be convenient to trig a note to audition a Program or Performance. You do this by pressing **SHIFT+RIGHT OCTAVE SHIFT (NOTE TRIG)** buttons. This will generate the note C4 for as long as you keep the buttons depressed.

## SELECTING PROGRAMS

Programs are single sounds that are stored in the internal memory of Nord Lead 3. The internal Program memory in Nord Lead 3 consists of 8 Banks with 128 Programs each. All Programs are stored in Flash Memory and can be edited and replaced as you wish. There are also four Slots labelled A to D. The Slots can be used for layering and quickly switching between Programs as described below. They are also used when the Nord Lead 3 is played via MIDI.

1. Select the Slot to use by pressing one of the four **SLOT** buttons A to D. When you are only playing one sound at a time, as you will now, you can select any Slot.

*Press one of the four SLOT buttons to activate a Slot. The corresponding LED will light up.*



2. Use the **ROTARY DIAL** to select a Program for the selected Slot. To switch between Banks, press the **UP/DOWN NAVIGATOR** buttons. The Bank is indicated by the leftmost digit and the Program by the rightmost digit in the **DISPLAY**.

It's also possible to select Programs by Category or in alphabetical order. See [“Searching for and loading Programs”](#) on page 26.

## USING THE SLOTS

The four Program Slots A to D can be thought of as four temporary memories (edit buffers) that you can load Programs into for playing and editing. When you select one of the Slots you will switch to play the

Program selected for that Slot. For live performance, for example, you can set up each Slot to play a different Program and quickly switch between them by pressing the SLOT buttons A to D.

**Note!** The four Slots share the same internal memory, i.e. a given Program will sound the same regardless which Slot you load it to. You could actually load the same Program to all four Slots and edit them separately. However, as soon as you save the Program again to its original memory location from any of the Slots, the original Program will of course be overwritten.

## LAYERING

### ACTIVATING SLOTS

You can play more than one Program at a time. Proceed as follows:

1. Set up the Slots to play the Programs you want to use.
2. To activate more than one Slot, simply press all the SLOT buttons you want to use, at the same time.

All the Slots' LEDs light up. The one you pressed last is flashing. This will be the one you are editing from the front panel, but more on this in [“Editing a Program in a layer” on page 22.](#)

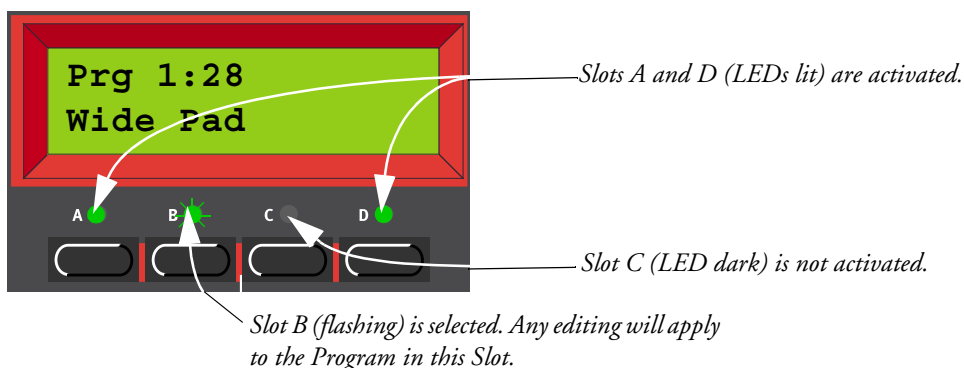

### DEACTIVATING SLOTS

To deactivate a Slot in the layer, press **SHIFT** and the SLOT button.

### POLYPHONY

Nord Lead 3 has 24 notes polyphony - also when you use stereo Unison (see [page 109](#)).

### REPLACING A PROGRAM IN THE LAYER

You might want to select another Program for one of the Slots in the layer:

1. Press the SLOT button that you want to select a new Programs for. Its LED will flash to indicate that it is the active Slot.
2. Select a new Program for the Slot with the **ROTARY DIAL**. To switch between Banks faster you can use the **UP/DOWN NAVIGATOR** buttons.



## KEYBOARD SPLIT

The Keyboard Split function allows you to split the keyboard in two sections, each playing separate Programs. This can be very useful when you are playing live, since it lets you use the Nord Lead 3 as if it were two independent synthesizers, with different sounds. When Keyboard Split is activated, Slots A and B will be played from the lower part of the keyboard, while Slots C and D will be played from the upper part. Activate Keyboard Split as follows:

1. Press **SLOT A** and select a Program for it. This will be the sound heard when you play the lower part of the keyboard.
2. Select **SLOT C** and select a Program for it. This will be the sound heard when you play the upper part of the keyboard.
3. Press the **SLOT A** and **SLOT C** buttons at the same time so that the LEDs above both Slot buttons light up (the LED for the last pressed Slot button will flash).
4. Press the **KEYBOARD SPLIT** button. The red LED above the button lights up to indicate that the keyboard is split.

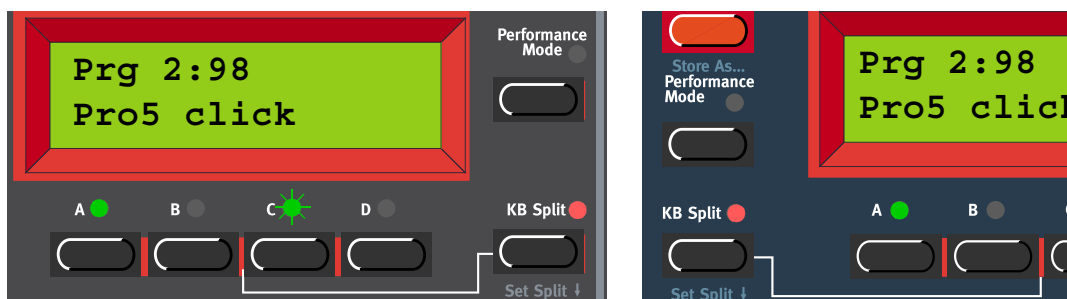

If you now play the keyboard, you will hear the sound of Slot A from the left part of the keyboard, and the sound of Slot C from the right part of the keyboard.

5. To exit the Keyboard Split mode, press the **KEYBOARD SPLIT** button again.

## SETTING THE SPLIT POINT

You set the Split Point (the key where the keyboard should be split) in the following way:

1. Hold down **SHIFT** and press the **KEYBOARD SPLIT** button.

The display shows the current Split Point for as long as you keep both buttons depressed.

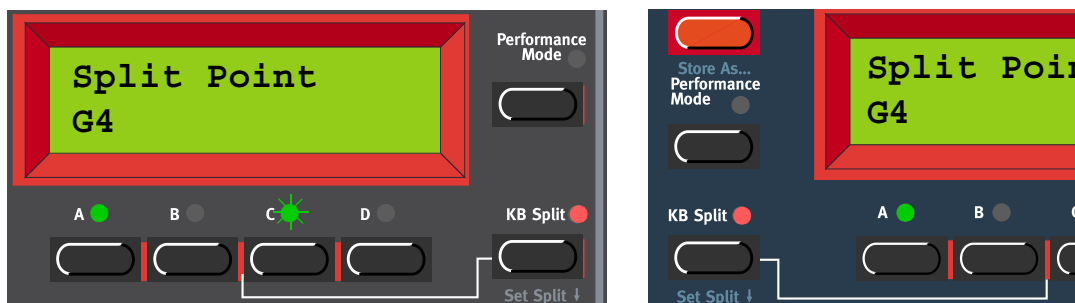

2. While holding down both the SHIFT and KEYBOARD SPLIT buttons, press the lowest key for the upper split section of the keyboard.  
**Important! On Nord Rack 3, first hold down both the SHIFT and KEYBOARD SPLIT buttons, and then release the buttons. Press the lowest key for the upper split section on the MIDI keyboard.**  
 The display shows the key you press.
3. On Nord Lead 3, release the SHIFT and KEYBOARD SPLIT buttons to exit. On Nord Rack 3, release the key on the MIDI keyboard to exit. **Note! On Nord Rack 3 you can also exit by pressing SHIFT (without needing to set a new Split Point from the MIDI keyboard).**

### COMBINING SPLIT AND LAYER

Since Slots A and B will be played from the lower part of the split keyboard, and Slots C and D from the upper part, you can split the keyboard and play layers of two sounds on each keyboard half. Just select all Slots, and activate Keyboard Split.

## PERFORMANCES

A Performance is a collection of up to four Programs, one for each Slot. Furthermore, the Performance contains information about which Programs should be active (layered), and settings for Keyboard Split. A Performance also contains information about what MIDI Channels to use for each slot, and a number of other settings, but this is described in detail in [Chapter "6. Performances" on page 32](#). This text is only meant as a quick introduction to playing the factory Performances.

1. If you are controlling the Nord Lead 3 via MIDI, make sure you transmit/receive on MIDI Channel 16. This is because the factory Performances are set to receive on MIDI Channel 16. Naturally, you can change MIDI Channels for a Performance. See ["MIDI Global" on page 120](#).
2. Enter Performance mode by pressing **PERFORMANCE MODE**. The **DISPLAY** shows the latest selected Performance. The Performances are organised in two Banks with 128 memory locations each.

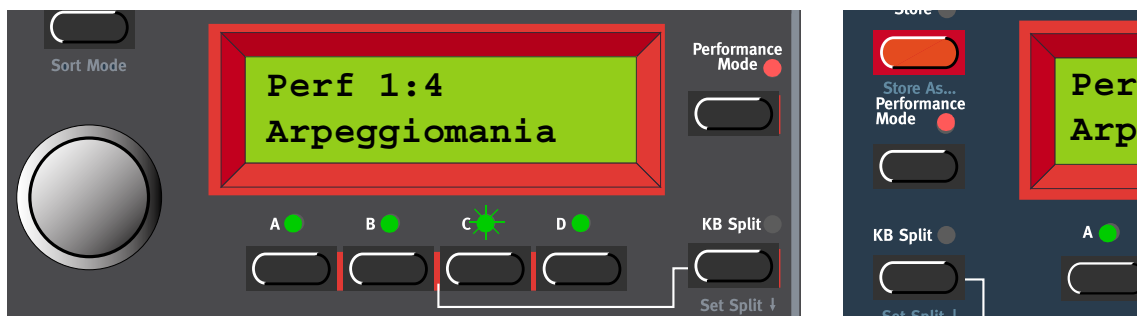

3. Select a Performance by scrolling with the **ROTARY DIAL**. The Performance is instantly loaded and you can try it out.
4. To exit Performance Mode, press the **PERFORMANCE MODE** button.

## ALTERNATING BETWEEN PROGRAM MODE AND PERFORMANCE MODE

When you switch between Program Mode and Performance Mode, the Slots are automatically loaded with the latest selected Slot/sound configuration. In certain situations you might want to “transfer” a layer you have been working on in Program Mode to the Performance Mode. To do this, hold down **SHIFT** and press the **PERFORMANCE MODE** button. Now, the Slot configuration you have in Program Mode will be copied to Performance Mode. This operation can also be done if you want to switch from Performance Mode to Program Mode and keep the same Slot/sound configuration.

## POLYPHONIC AND MONOPHONIC OPERATION

For each Program you can select Voice Mode (Poly, Mono, Legato). The exact nature of these modes are described in ["Voice mode" on page 106](#). If you are using more than one output, or headphones, you might want to know something about how the sounds get positioned in the stereo image. This depends

on the Audio Routing settings described on [page 125](#). By default, the Audio Routing setting is prepared for Stereo. All you have to do to get a stereo effect in your sound is pressing the UNISON button



## UNISON

To make a sound fatter, you can activate the Unison function. You adjust the detune by turning the DETUNE knob. Note that the Unison function is in stereo (if the Audio Routing is set to stereo, see [page 125](#).) and does not reduce the polyphony!



## PITCH STICK AND MODULATION WHEEL

### PITCH STICK (NORD LEAD 3 ONLY)

The PITCH STICK is used to bend the notes, just as with a pitch bend wheel on traditional synthesizers. The pitch stick differs from other pitch bend devices in a couple of ways:

- There is no dead center in the middle of the throw. This allows you to use the pitch stick for natural vibrato, pretty much like a guitarist can.
- The effect on the pitch is exponential, that is, the further you move the stick away from the center position, the more drastic the effect.

### PITCH BEND RANGE SETTINGS

The PITCH STICK bend range is set globally for the entire instrument. It's possible to set different ranges for bending down and up. To set the bend ranges of the PITCH STICK and for incoming MIDI pitch bend data, proceed as follows:

1. Press the SYNTH button and then the DOWN NAVIGATOR button till the DISPLAY reads 'Bend Range'.

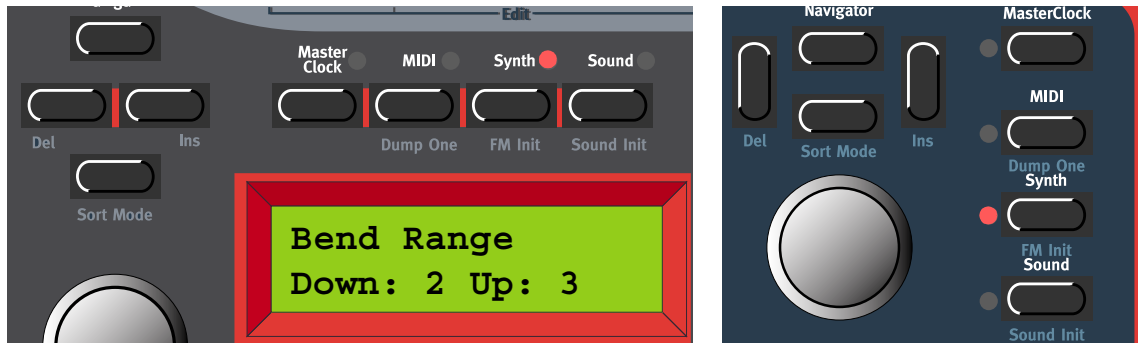

2. Change the bend range, in semitones, with the ROTARY DIAL. Select between the 'Down' and 'Up' ranges by pressing the LEFT or RIGHT NAVIGATOR buttons. The maximum range is +/-12 semitones (+/-1 octave).
3. Exit by pressing the SYNTH button.

### MODULATION WHEEL AND MOD WHEEL MIDI DATA

The effect of moving the MODULATION WHEEL can be different for each Program. You decide what you want it to affect by assigning parameters to the Wheel Morph function (see [Chapter "5. Morph groups" on page 29](#)). The MODULATION WHEEL can also be set to control the global Vibrato function described on [page 105](#).

### MASTER TUNE

The Master Tune function is global for the instrument, i.e. it affects all Slots. To tune Nord Lead 3 to other instruments, proceed as follows:

1. Press the SYNTH button and then the UP NAVIGATOR button until the DISPLAY reads 'Master Tune'.

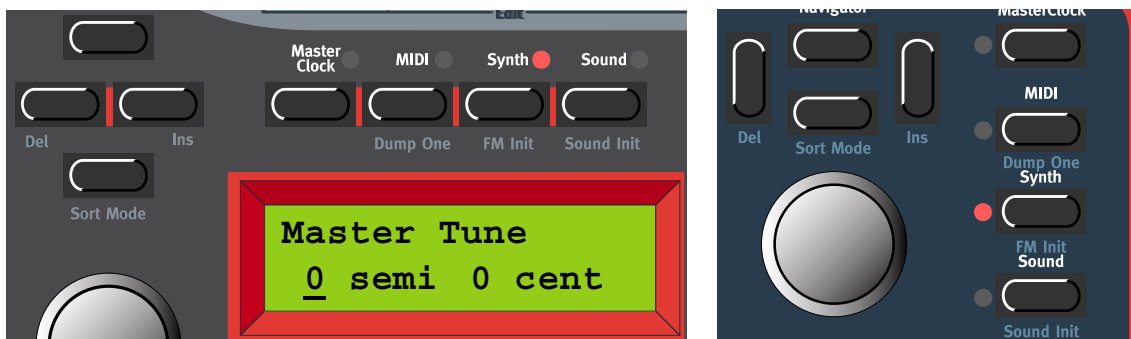

2. Change the master tune, in semitones, with the ROTARY DIAL. '0' is normal 440Hz tuning. The range is +/- 6 semitones in steps of 1 semitone. Press the RIGHT NAVIGATOR button to change the Master Tune, in cents, with the ROTARY DIAL. The range is +/- 1 semitone in steps of 1 cent (hundreds of a semitone).
3. Exit by pressing the SYNTH button.

## USING A SUSTAIN PEDAL

A foot switch connected to the SUSTAIN PEDAL input works like a sustain pedal on a piano. Set it up as follows:

1. Press the SYNTH button and then the DOWN NAVIGATOR button till the DISPLAY reads 'Sustain Pedal'.

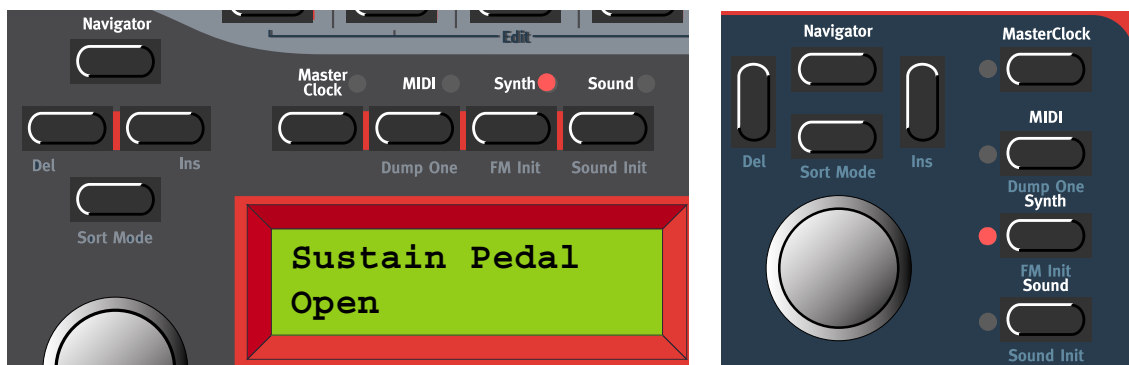

2. Change sustain pedal polarity between 'Open' (open when pressed) and 'Closed' (closed when pressed) with the ROTARY DIAL.
3. Exit by pressing the SYNTH button.

Nord Lead 3 will also send and receive Sustain Pedal messages via MIDI (CC# 64).

**Note:** You can choose to enable/disable the Sustain Pedal function separately for each Slot. This is especially useful when you are creating a Performance and only want some Slots to respond to sustain. See ["Active Device" on page 116](#).

## USING A CONTROL (EXPRESSION) PEDAL

As indicated in the illustration on [page 10](#), a regular resistive (range 10 kOhm to 50 kOhm) expression pedal can be connected to the Control Pedal input, using a stereo (Tip-Ring-Sleeve) cable. The connected pedal can be used to control a separate Morph Group in a Program (see [Chapter "5. Morph groups" on page 29](#)), i.e. any single parameter or combination of parameters featuring a circular LED graph. Nord Lead 3 will also send and receive Expression pedal messages via MIDI (CC# 11).

## THE 'PANIC' BUTTON

If notes should "hang" or the Nord Lead 3 should behave strange, all you need to do is hold down the SHIFT button and press KB HOLD (PANIC). This will execute an internal All Notes Off, and reset certain parameters to their normal values.



## 4. EDITING PROGRAMS

### EDITING A PROGRAM

Actually, how to change a programmed sound can be described in one sentence: “tweak the knobs and press the buttons”. It *is* as simple as that! Don’t be afraid to edit and overwrite the factory Programs. If you want to restore any of the original factory programs later, you can fetch them at <http://www.clavia.se> and download to your Nord Lead 3 as MIDI SysEx.

To indicate that a Program has been edited (changed from the stored version), an asterisk is shown after the Program number in the DISPLAY:.



### THE KNOBS WITH CIRCULAR LED GRAPHS

The KNOBS combined with the circular LED GRAPHS gives you instant information about the parameter settings. The LED GRAPH gives a coarse indication of the parameter value and the DISPLAY shows the exact value with the corresponding unit ('Hz' for frequency, 's' for seconds etc.). It's also possible to monitor a parameter's exact setting without changing its value. Hold down the MONITOR/COPY button and turn the KNOB for the parameter you want to monitor.

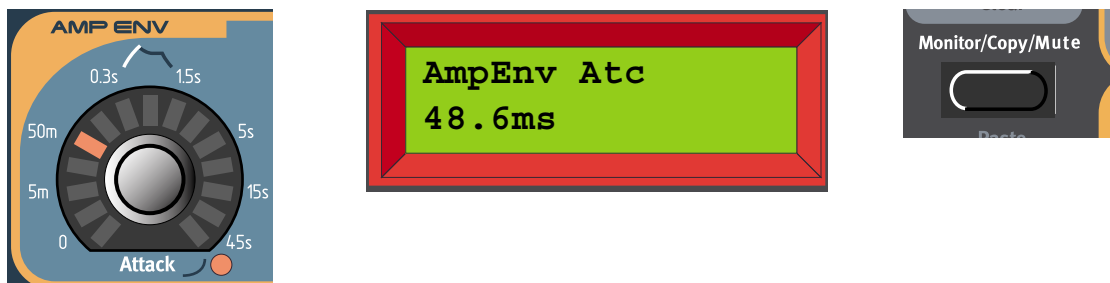

Several KNOBS have alternative functionality (printed in blue below some KNOBS on the front panel), which you can activate by holding down the SHIFT button and turning the KNOB clockwise. The red LED next to the parameter indicates when you use the alternative functionality. To deselect the alternative functionality, hold down SHIFT and turn the KNOB counter-clockwise.

## THE BUTTONS

Press a **BUTTON** to select between functions printed in white. Hold down **SHIFT** and press the **BUTTON** to select alternative functions (printed in blue below some **BUTTONS**).



## EDITING A PROGRAM IN A LAYER

When you have layered sounds you can edit one of the sounds at a time from the front panel. Do like this:

1. Press the **SLOT** button with the Program that you want to edit. The **SLOT** LED will flash to indicate it's the active Slot.
2. Edit the sound.

## REVERTING TO THE ORIGINAL PROGRAM

If you have edited a Program and want to get back to the stored original, proceed as follows:

1. Select another Program for that Slot with the **ROTARY DIAL**.
2. Select the original Program again by turning the **ROTARY DIAL** in the opposite direction. The sound has now reverted back to the way it was when you originally selected it.

## USING 'SOUND INIT' AND 'FM INIT'

If you want to create a sound from "scratch" but don't want to edit an existing Program, there are two functions that make it much easier to get started: 'Sound Init' and 'FM Init'. 'Sound Init' can be used when you want to create an "analog-style" subtractive sound. 'Sound Init' automatically resets all parameters to a basic default setting. From here it's often easier to start with the editing than from an existing Program. 'FM Init' can be used in the same way and is intended as a base for creating FM sounds.

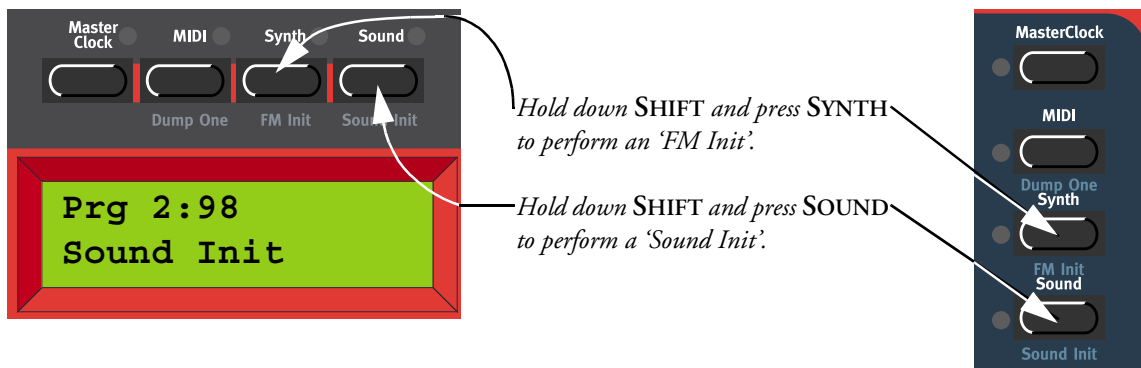



## MUTING PARAMETER SECTIONS

When you're editing a Program it may sometimes be convenient to temporarily mute certain parameter sections so you can hear how they affect the sound



By holding the **MONITOR/COPY/MUTE** button and pressing any of the following **SELECTOR** buttons, the selected parameter section is temporarily muted (disabled): LFO1 or 2 Destination, MOD ENV Destination, OSC1 or 2 Waveform, OscMod Mode and Filter Type.

A muted parameter section is indicated by the corresponding **SELECTOR LED** flashing.

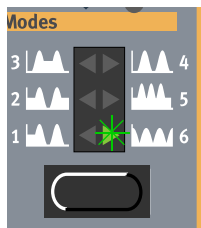

To revert to normal state, and thus activate the parameter section/function again, press the corresponding **SELECTOR** button or the **MONITOR/COPY/MUTE** button together with the corresponding **SELECTOR** button.

**Note!** You cannot store any Mute settings with the Program.

## STORING A PROGRAM

Storing is done identically regardless if you are saving an edited Program or if you have used 'Sound Init' or 'FM Init' to create a sound from scratch. Storing a Program will permanently overwrite an existing Program. Be careful so that you don't accidentally erase a Program you'd like to keep!

**Note!** When Nord Lead 3 is shipped from factory, Memory Protect is set to 'On'. To be able to store Programs, first disable the Memory Protect function. See ["Memory Protect" on page 129](#).

Storing a Program can be done in two ways:

## STORING WITHOUT CHANGING THE PROGRAM NAME

1. Press the STORE button once. The LED above it starts flashing.

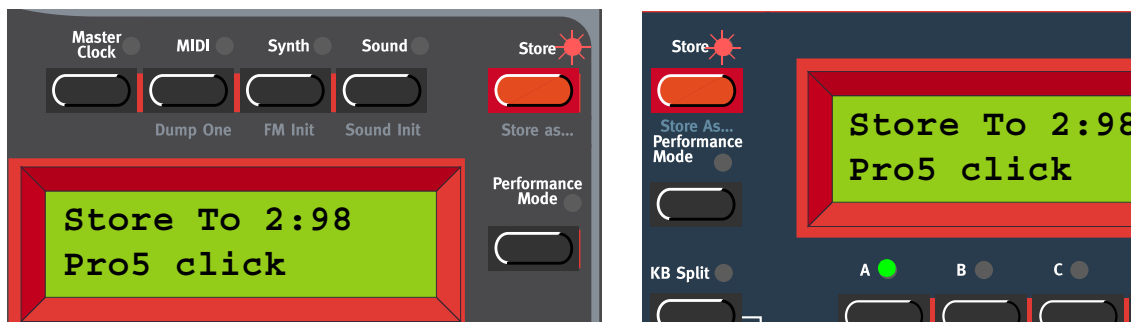

2. Select memory location by turning the ROTARY DIAL. Switch between Banks 1-8 by pressing the UP/DOWN NAVIGATOR buttons. As you scroll through the memory locations, you can play and hear the Program currently shown in the DISPLAY. This prevents you from overwriting a sound that you want to keep.
3. Press STORE again to store your Program. (To cancel the operation, press a SLOT button.)

## STORING WITH THE POSSIBILITY TO SELECT CATEGORY AND/OR CHANGE THE PROGRAM NAME

To make it easier to find different types of sounds in the synth's memory it's possible to save Programs in separate Categories. When you're looking for a specific sound you can search either by category, in alphabetical order or numerically. There are 12+2 different categories to choose between:

CATEGORY	DESCRIPTION
Acoustic	Sounds with an acoustic character like flutes, violins, guitars, ethnic sounds, bells, mallets etc. Doesn't necessarily have to be emulations of existing instruments
Arpeggio	All sorts of arpeggio and "groove" sounds
Bass	All sorts of bass sounds
Classic	Traditional "clean" analog types of polyphonic synth sounds based on the classic waveforms
Drum	Drum and percussion sounds
Fantasy	Melodic effects sounds and textures, often with rhythmic modulations
FX	Atonal effects sounds like water, laser guns, explosions etc. Sometimes with heavy modulations. Quite often built up using Noise "waveforms"
Lead	Sounds meant for lead lines. Usually monophonic sounds. Also lead "chord memory" sounds
Organ	Different types of organ sounds

CATEGORY	DESCRIPTION
Pad	Melodic polyphonic “chord” sounds with fairly slow attacks like strings, choirs etc.
Piano	Piano type sounds like EP Tines and EP Reeds emulations and FM based piano sounds
Synth	All sorts of melodic polyphonic synth sounds
User1	Reserved for your own sounds
User2	Reserved for your own sounds

To store a Program in a Category and change the Program name, do like this:

1. Hold down **SHIFT** and press **STORE** (Store as...). The **STORE LED** starts flashing and the **DISPLAY** shows the current Sound Category or, if no Sound Category was selected, 'Name: No Cat'.



2. Select Category with the **ROTARY DIAL**. Let's say we select 'Synth' in this example.
3. Press the **RIGHT NAVIGATOR** button once and select letters for the Program name by turning the **ROTARY DIAL**. Change the cursor position with the **LEFT** and **RIGHT NAVIGATOR** buttons.



Alternatively, press and hold the **DOWN NAVIGATOR** button and select letters with the **ROTARY DIAL**. Each time you release the **DOWN NAVIGATOR** button the cursor in the **DISPLAY** advances one step. Repeat the procedure for the entire Program name. If you want to delete a letter/position and thus move all the letters to the right of the cursor one step back, hold down **SHIFT** and press the **LEFT NAVIGATOR (DEL)** button. (This function is the same as using the Delete key on a computer keyboard.) If you want to move all letters to the right of the cursor one step forward and thus make room for more letters, hold down **SHIFT** and press the **RIGHT NAVIGATOR (INS)** button. (Press a **SLOT** button to cancel the Storing operation).



4. Press **STORE** again. The **STORE LED** continues flashing. Select memory location by turning the **ROTARY DIAL**. Switch between Banks 1-8 by pressing the **UP/DOWN NAVIGATOR** buttons. As you scroll through the memory locations, you can play and hear the Program currently shown in the **DISPLAY**. This prevents you from overwriting a sound that you want to keep.
5. Press **STORE** again to store your Program. (To cancel the operation, press a **SLOT** button.)

## SEARCHING FOR AND LOADING PROGRAMS

By default, when you load a Program into a Slot by first selecting Bank with the **UP/DOWN NAVIGATOR** buttons and then turning the **ROTARY DIAL**, the Programs are displayed (and loaded) in numerical order. However, you can change the search mode to either alphabetical or by Category.

### SEARCH FOR A PROGRAM IN A SPECIFIC CATEGORY

By holding down **SHIFT** and pressing the **DOWN NAVIGATOR** button twice you will be able to load Programs by Categories rather than by memory location number. The Programs within a Category will be

displayed and loaded in alphabetical order. Select Category by pressing the UP/DOWN NAVIGATOR buttons and select Program with the ROTARY DIAL or with the LEFT/RIGHT NAVIGATOR buttons.



### SEARCH FOR A PROGRAM IN ALPHABETICAL ORDER

By default, when you load a Program into a Slot by turning the ROTARY DIAL, the Programs are displayed (and loaded) in numerical order. By pressing the SHIFT + DOWN NAVIGATOR buttons you will be able to load Programs in alphabetical order rather than by memory location number. Select letter by pressing the UP/DOWN NAVIGATOR buttons and select Program with the ROTARY DIAL or with the LEFT/RIGHT NAVIGATOR buttons.



Note: The selected 'Program Sort mode' (numerically, by category or alphabetically) can be saved using the 'Store System Settings' command in the Synth menu. (This way the selected search mode will be active every time you power on your Nord Lead 3.)

## COPYING PROGRAMS

### FROM ONE MEMORY LOCATION TO ANOTHER

Copying Programs from one memory location to another is just a variation of storing:

1. Select the Program you want to copy. Press the STORE button once. The LED above it starts flashing.
2. Select the destination memory location by turning the ROTARY DIAL. Switch between Banks by pressing the UP/DOWN NAVIGATOR buttons. As you scroll through the memory locations, you can play and hear the Program currently shown in the DISPLAY. This prevents you from overwriting a sound that you want to keep.
3. Press STORE again to store your Program. (To cancel the operation, press a SLOT button.)

Of course you could also copy a Program to a new memory location and change the Program name. Just follow the instructions in the paragraph ‘Storing with the possibility to change the Program name’ above.

### FROM ONE SLOT TO ANOTHER

You can also copy a Program from one Slot and paste it to another Slot. To copy and paste a Program from one Slot to another, do like this:

Press and hold the MONITOR/COPY button and while holding it press the SLOT button containing the Program you want to copy. Release all buttons. Press and hold SHIFT+MONITOR/COPY (Paste) and while holding them press the destination SLOT button.

**Note:** The copied Program is not stored in any memory location with this operation. It is only copied to the new Slot’s edit buffer.

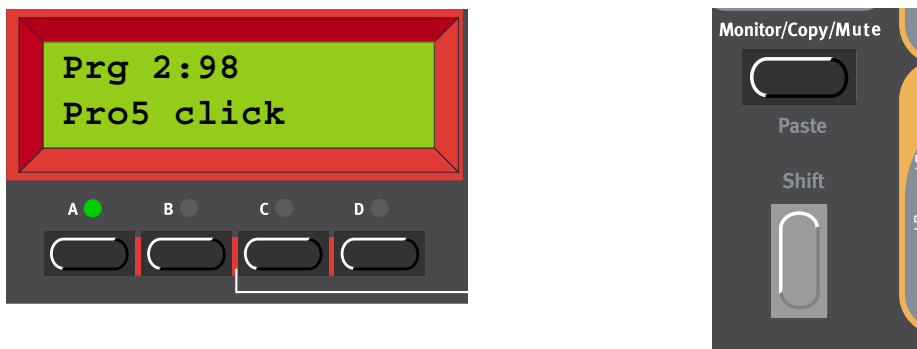

(For more information about the Monitor/Copy function, please refer to [page 133](#).)

## DELETING PROGRAMS

There is no command for deleting single Programs from the internal memory. What you do to “delete” a Program is simply saving a new Program and replacing the old one in a specific memory location. However, you can erase complete Banks of Programs with a single command. You do this by using the ‘Program Bank Receive’ function described on [page 126](#). After you have selected a Bank to erase and erased it, you simply exit without downloading a new Bank of Programs.

## DOWNLOADING PROGRAMS VIA MIDI

You can receive MIDI SysEx data for one Program at a time into a Slot’s edit buffer. For example, if you use Nord Lead 3 together with a sequencer, it is often practical to record a SysEx Program data dump in the beginning of your song to download sounds. See “[Dump One](#)” on [page 122](#) for info on how to perform a single Program SysEx dump. It’s also possible to receive a complete Program Bank via MIDI SysEx. See “[Program Bank Receive](#)” on [page 126](#).

# 5. MORPH GROUPS

The Morph function lets you continuously control defined ranges of several parameters in a Program, using only a single control source. This lets you produce radical changes in a sound in a very fast and easy way. Nord Lead 3 features four separate Morph groups per Program. You may assign up to 26 parameters *per Morph group* in each Program. All knobs with circular LED graphs can be assigned to a Morph group. The control sources are Keyboard Velocity, Keyboard Range, Keyboard Aftertouch/Control Pedal and Modulation Wheel.

## ASSIGN PARAMETERS TO A MORPH GROUP

In the example below we will assign all parameters of the Amp Env group to the MOD WHEEL. However, the procedure is exactly the same for the other parameters and Morph groups as well. This figure shows the current parameter settings:



1. Press and hold the WHEEL MORPH ASSIGN button.

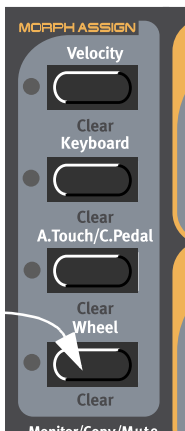

2. All circular LED graphs on the front panel will go blank.

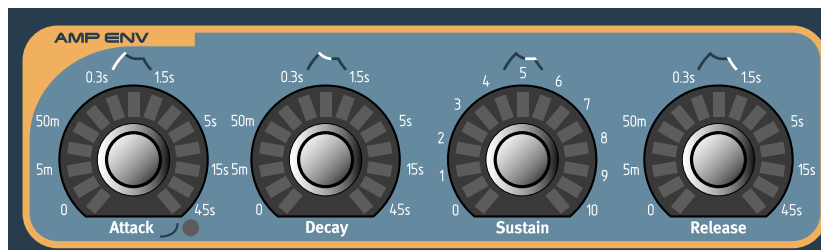

- Turn the parameter **KNOBS** you want to assign to the Morph group. The first and last LED of the Morph range will light up. A Morph range can be either negative or positive according to your choice. The “zero” Morph value is the parameter’s initial setting.



- As soon as you assign the first parameter in a Morph group the green LED above the **MORPH ASSIGN** button will light up to indicate that the Morph group is now active.

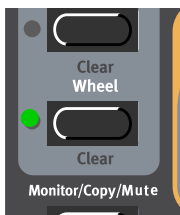

If you want to see all the parameters’ initial settings again, just release the **MORPH ASSIGN** button and the LED graphs will light up again to show the settings. To continue the Morph assignment, press the **MORPH ASSIGN** button again.



To change the initial parameter value(s) and thus move the entire Morph range (sector), just change the parameter value without pressing the **MORPH ASSIGN** button (just as you would change an unassigned parameter).

The Wheel and Aftertouch/Pedal Morphs will show the actual parameter values when you change the source value. The Velocity and Keyboard Morphs don’t show the actual parameter values as you play on the keyboard. It’s made this way because it gets irritating after a while to watch all flickering LEDs as you play. However, if you press and hold the **MONITOR/COPY** button and play the keyboard you can view the Velocity and Keyboard morphs as well.

**Note:** If you have assigned the same parameter to several Morph groups and control the parameter simultaneously from the different Morph group control sources, the parameter values will be added. This means that the parameter value can go beyond the ranges set for each individual Morph group.

**Tip!** If you want to enter Morph Assign mode without needing to hold the **MORPH ASSIGN** button you can double-click the **MORPH ASSIGN** button. Click again to exit Morph Assign mode.



## DEASSIGN PARAMETERS FROM A MORPH GROUP

1. Press and hold the MORPH ASSIGN button. The parameters assigned to that Morph group will indicate their morph ranges.
2. Turn the parameter KNOB you wish to deassign till it meets the initial value. The LED graph will go blank to indicate that the parameter has been deassigned from the Morph group.

To deassign all assigned parameters from a Morph group, hold down Shift and press the corresponding Morph Assign button (Morph Clear).

## COPY A MORPH GROUP TO ANOTHER SOURCE

The special Copy/Paste function can be used to copy an entire Morph Group with all its assigned parameters from one Morph source to another. To copy and paste a Morph Group, do like this: Press and hold the MONITOR/COPY button and while holding it press a MORPH GROUP button. Release all buttons. Press and hold SHIFT+MONITOR/COPY (Paste) and while holding them, press the new destination MORPH GROUP button. Now, all parameters have been copied and pasted to the new source.

## A WORD ABOUT KEYBOARD MORPH

Keyboard Morph lets you control the Morphed parameters differently depending on where on the keyboard you play. The minimum source value is the lowest key of the Nord Lead 3 keyboard when no Octave Shift is used, i.e. note C3, and maximum is the highest key, i.e C5. When you transpose the keyboard up or down, the Keyboard Morph range will extend beyond the set Morph limits.

Tip! This function makes it easy to create, for example, "custom made" Filter Keyboard Tracking. When you assign cutoff frequency to Keyboard Morph, the DISPLAY also shows the actual keyboard tracking in %. Just make sure you deselect the KB TRACK function in the filter section to make this work as intended. See also "[Keyboard Morph](#)" on page 136 for info on how to use the DISPLAY when creating a Keyboard Morph.

## A WORD ABOUT CONTROL PEDAL MORPH

The Aftertouch Morph and Control Pedal Morph share the same Morph group. If you plug in a Control Pedal, the Aftertouch assignment will automatically switch to be assigned to the Control (Expression) Pedal instead.

Note! You can select if you don't want the Morph group to automatically switch to from Aftertouch to Pedal when a Control Pedal is plugged in. See "[Morph3 Source](#)" on page 124 for more info.

## MORPHING CLOCK-SYNCHED PARAMETERS

It's not possible to Morph a clock-synched parameter. You can assign and set a Morph range on a clock-synched parameter, but Morphing it will have no effect.

# 6. PERFORMANCES

## WHAT IS A PERFORMANCE?

A Performance is a complete setup of up to four Programs/sounds, one for each Slot. Nord Lead 3 has 256 (2 x 128) memory locations for Performances. A Performance contains information about which Slots should be active (layered), and settings for Keyboard Split. A Performance also contains information about what MIDI Channels to use for each Slot, and a number of other settings. Later in this chapter follows a detailed list of what settings are contained in a Performance.

Note that the edits and settings you make for each individual Program/sound in a Performance do not affect the original Program in any way. The Performance memory is completely separate from the Program memory.

## RECALLING A PERFORMANCE

When you recall a Performance, you replace the four Programs currently in the Slots A to D with the sounds in the Performance. You also recall other settings as listed in the table later in this chapter.

1. Enter Performance mode by pressing the PERFORMANCE MODE button.



The display shows the latest selected Performance. The Performances are organised in two Banks with 128 Performances each.

2. Scroll with the ROTARY DIAL to select a Performance. The Performance is instantly loaded and you can try it out. You can also select Performances via MIDI, see [“Program Change” on page 139](#).

Please note that selecting a new Performance changes a lot of parameters, including MIDI Channels and settings for each Slot. This might lead to silent sounds!

## CREATING A PERFORMANCE

### SELECTING PROGRAMS FOR THE SLOTS

To select Programs as base in a Performance, do like this:

1. Hold down the desired SLOT button (A in this example). The SLOT LED flashes to indicate that it's the active Slot. The DISPLAY shows which memory location the original Program for Slot A was fetched from and its name.



2. Select a new Program for the Slot by holding down the SLOT A button and scrolling with the ROTARY DIAL. To switch between Program Banks, hold down the SLOT A button and use the UP/DOWN NAVIGATOR buttons. Repeat the procedure for the other Slots.

If you want to deselect a Slot and exclude it from the Performance, hold down SHIFT and press the desired SLOT button. Do the same if you want to include a deselected Slot in your Performance.

### EDITING

This is done just as in Program mode. To activate a Slot for editing, simply press the desired SLOT button. The LED above it flashes to indicate it's the currently active Slot.

**Note that when you save the Performance you save the edited Programs/sounds within the Performance. The original Program(s) (from the Program memory) that you used as base for the Performance is not affected in any way.**

### SOLO SINGLE SOUNDS IN A PERFORMANCE

It's possible to temporarily "isolate" and solo single sounds in a Performance to make it easier to hear what you're editing. Do like this to solo a sound in a Performance:

1. Enter Performance mode by pressing the PERFORMANCE MODE button. Scroll with the ROTARY DIAL to select a Performance.



2. Double-click a SLOT button used in the Performance (Slot A in this example). All other selected SLOT LEDs go blank. The DISPLAY shows which memory location the original Program for Slot A was fetched from and its name.



3. When you play the keyboard you'll only hear the sound of Slot A alone. If you want to solo another sound (Slot) in the Performance, just double-click the corresponding SLOT button.
4. To revert to normal playback, press any of the SLOT buttons that are active in the Performance.

### KEYBOARD SPLIT

The Keyboard Split function allows you to split the keyboard in two sections, each playing separate sounds. When Keyboard Split is activated, Slots A and B will be played from the lower part of the keyboard, while Slots C and D will be played from the upper part. Activate Keyboard Split as follows:

1. Press SLOT A and select a Program for it. This will be the sound heard when you play the lower part of the keyboard.
2. Select SLOT C and select a Program for it. This will be the sound heard when you play the upper part of the keyboard.
3. Press the SLOT A and SLOT C buttons at the same time so that the LEDs above both Slot buttons light up (the LED for the last pressed Slot button will flash).

- Press the **KEYBOARD SPLIT** button. The red LED above the button lights up to indicate that the keyboard is split.



If you now play the keyboard, you will hear the sound of Slot A from the left part of the keyboard, and the sound of Slot C from the right part of the keyboard.

- To exit the Keyboard Split mode, press the **KEYBOARD SPLIT** button again.

#### SETTING THE SPLIT POINT

You set the Split Point (the key where the keyboard should be split) in the following way:

- Hold down **SHIFT** and press the **KEYBOARD SPLIT** button.

The display shows the current Split Point for as long as you keep both buttons depressed.

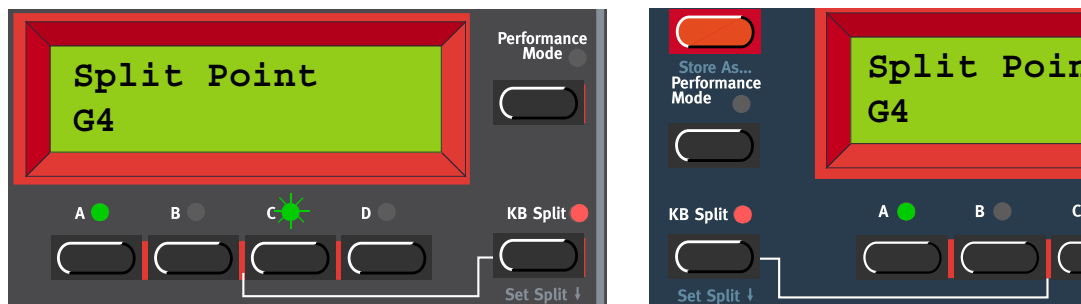

- While holding down both the **SHIFT** and **KEYBOARD SPLIT** buttons, press the lowest key for the upper split section of the keyboard.  
**Important! On Nord Rack 3, first hold down both the SHIFT and KEYBOARD SPLIT buttons, and then release the buttons. Press the lowest key for the upper split section on the MIDI keyboard.**  
The display shows the key you press.
- On Nord Lead 3, release the **SHIFT** and **KEYBOARD SPLIT** buttons to exit. On Nord Rack 3, release the key on the MIDI keyboard to exit. **Note! On Nord Rack 3 you can also exit by pressing SHIFT (without needing to set a new Split Point from the MIDI keyboard).**

#### COMBINING SPLIT AND LAYER

Since Slots A and B will be played from the lower part of the split keyboard, and Slots C and D from the upper part, you can split the keyboard and play layers of two sounds on each keyboard half. Just select all Slots, and activate Keyboard Split.

## STORING A PERFORMANCE

Note! When Nord Lead 3 is shipped from factory, Memory Protect is set to 'On'. To be able to store Performances, first disable the Memory Protect function. See [“Memory Protect” on page 129](#).

### STORING WITHOUT CHANGING THE NAME

1. Press the STORE button once. The LED above it starts flashing.



2. Select memory location by turning the ROTARY DIAL. Switch between Banks 1-2 by pressing the UP/DOWN NAVIGATOR buttons. As you scroll through the memory locations, you can play and hear the Performance currently shown in the DISPLAY. This prevents you from overwriting a Performance that you want to keep.
3. Press STORE again to store your Performance. (To cancel the operation, press a SLOT button.)

### STORING WITH THE POSSIBILITY TO CHANGE THE NAME

1. Hold down SHIFT and press STORE (Store as...). The LED starts flashing and the DISPLAY shows 'Set Name:'. Select letters with the ROTARYDIAL and change the cursor position with the LEFT and RIGHT NAVIGATOR buttons.

Alternatively, press and hold the DOWN NAVIGATOR button and select letters with the ROTARY DIAL. Each time you release the DOWN NAVIGATOR button the cursor in the DISPLAY advances one step. Repeat the procedure for the entire Program name. If you want to delete a letter/position and thus move all the letters to the right of the cursor one step back, hold down SHIFT and press the LEFT NAVIGATOR (DEL) button. (This function is the same as using the Delete key on a computer keyboard.) If you want to move all letters to the right of the cursor one step forward and thus make room

for more letters, hold down SHIFT and press the RIGHT NAVIGATOR (INS) button. (Press a SLOT button to cancel the Storing operation).



2. Press STORE again. The LED continues flashing. Select memory location by turning the ROTARY DIAL. Switch between Banks 1-2 by pressing the UP/DOWN NAVIGATOR buttons. As you scroll through the memory locations, you can play and hear the Performance currently shown in the DISPLAY. This prevents you from overwriting a Performance that you want to keep.
3. Press STORE again to store your Performance. (To cancel the operation, press a SLOT button.)

The Programs you use in the Performance Slots are saved complete with all parameter settings when the Performance is saved. The above point means that there is no need to store the Programs separately. As soon as you save the Performance, all Programs that it uses are also saved, within the Performance. This also means that if you later change any of your Programs, in Program mode, the Programs in the Performances are not affected in any way.

## NAMING SINGLE SOUNDS IN PERFORMANCES

It's also possible to name each of the sounds in a Performance individually. Do like this:

1. Enter Performance mode by pressing the PERFORMANCE MODE button. Scroll with the ROTARY DIAL to a Performance of your choice.



2. Press the SLOT button for the sound you want to name (Slot A in this example). The corresponding SLOT LED flashes.



3. Press the SOUND button and then press the DOWN NAVIGATOR button repeatedly until the DISPLAY reads:



4. Select letters with the ROTARY DIAL and change the cursor position with the RIGHT and LEFT NAVIGATOR buttons. If you want to change the names of the other sounds in the Performance, simply press another SLOT button and repeat the naming procedure.
5. When you're finished with naming the sound(s), press STORE twice to store your Performance.



## EXTRACTING SINGLE SOUNDS FROM A PERFORMANCE

As stated earlier, the sounds (Programs) used in the Slots of a Performance are *not* references to regular, existing Programs, but complete patches “on their own”. You will find several unique sounds in the factory Performances; sounds that you will not find in any of the internal Program locations. You may want to extract such a sound, to use as a single Program, or to make it part of another Performance.

### EXTRACT A SOUND AND SAVE IT AS A PROGRAM

1. Select the Performance containing the sound you want to extract.
2. Press the **SLOT** button to activate the Slot (LED is flashing) containing the desired sound.
3. Press **STORE**. The **LED** above the **STORE** button starts flashing
4. Press the **PERFORMANCE MODE** button, to exit Performance mode.
5. Select Program memory location by turning the **ROTARY DIAL**. Switch between Banks by pressing the **UP/DOWN NAVIGATOR** buttons. As you scroll through the memory locations, you can play and hear the Program currently shown in the **DISPLAY**. This prevents you from overwriting a sound that you want to keep.
6. Press **STORE** again to store your Program. (To cancel the operation, press a **SLOT** button.)

The sound is now stored as a regular Program. The sound can now be played as a regular Program, or included in another Performance as described on the previous page.

### EXTRACT A SOUND, RENAME IT AND SAVE IT AS A PROGRAM

1. Select the Performance containing the sound you want to extract.
2. Press the **SLOT** button to activate the Slot (LED is flashing) containing the desired sound.
3. Hold down **SHIFT** and press **STORE** (Store as...). The **LED** above the Store button starts flashing and the **DISPLAY** shows ‘Set Perf Name:’.
4. Press the **PERFORMANCE MODE** button, to exit Performance mode. The **DISPLAY** now shows ‘Set Name:’. Select letters with the **ROTARYDIAL** and change the cursor position with the **LEFT** and **RIGHT NAVIGATOR** buttons.

Alternatively, press and hold the **DOWN NAVIGATOR** button and select letters with the **ROTARY DIAL**. Each time you release the **DOWN NAVIGATOR** button the cursor in the **DISPLAY** advances one step. Repeat the procedure for the entire Program name. If you want to delete a letter/position and thus move all the letters to the right of the cursor one step back, hold down **SHIFT** and press the **LEFT NAVIGATOR (DEL)** button. (This function is the same as using the Delete key on a computer keyboard.) If you want to move all letters to the right of the cursor one step forward and thus make room for more letters, hold down **SHIFT** and press the **RIGHT NAVIGATOR (INS)** button. (Press a **SLOT** button to cancel the Storing operation)

5. Press STORE again. The LED continues flashing. Select memory location by turning the ROTARY DIAL. Switch between Banks by pressing the UP/DOWN NAVIGATOR buttons. As you scroll through the memory locations, you can play and hear the Program currently shown in the DISPLAY. This prevents you from overwriting a sound that you want to keep.
6. Press STORE again to store your Program. (To cancel the operation, press a SLOT button.)

The sound is now stored as a regular Program. This can now be played as usual, or included in another Performance as described on the previous page.

## DELETING PERFORMANCES

There is no command for deleting single Performances from the internal memory. What you do to “delete” a Performance is simply saving a new Performance and replacing the old one in a specific memory location. However, you can erase complete Banks of Performances with a single command. You do this by using the ‘Performance Bank Receive’ function described on [page 127](#). After you have selected a Bank to erase and erased it, you simply exit without downloading a new Bank of Performances.

## EXITING PERFORMANCE MODE

1. To exit Performance mode, press the PERFORMANCE MODE button.

Now you return to the regular Program mode. You will note that the four slots now play the Programs that were selected before you entered Performance mode. Likewise, Layering and Shift functions are restored to the way they were before you entered Performance mode.

**Tip!** In certain situations you might want to “transfer” a layer you have been working on in Performance Mode to Program Mode. To do this, hold down SHIFT and press the PERFORMANCE MODE button. Now, the Slot configuration you have in Performance Mode will be copied to the Program Mode. This operation can also be done if you want to switch from Program Mode to Performance Mode and keep the same Slot/sound configuration.

## WHAT A PERFORMANCE CONTAINS

The following is a list of what a Performance contains, that is, what you actually save and recall when you work with Performances:

### FOR EACH SLOT

- The selected Program complete with its own parameter settings, including Arpeggio, Vibrato, Glide, Voice Mode, Unison, Chord Memory/Stack and Hold
- The MIDI Channel setting
- Control pedal assignment
- The Audio Routing settings
- The Active Device settings
- The Pitch Bend Range setting

### FOR THE ENTIRE INSTRUMENT

- The Master Clock tempo
- The Layer configuration
- The Keyboard Split settings
- Which Slot is active for editing
- Keyboard Hold (on or off)

## DOWNLOADING PERFORMANCES VIA MIDI

You can receive MIDI SysEx data for one Performance at a time into the Performance edit buffer (all four Slots together). For example, if you use Nord Lead 3 multitimbrally together with a sequencer, it is often practical to record a SysEx Performance data dump in the beginning of your song to download sounds, initialize global settings, etc. See [“Dump One” on page 122](#) for info on how to perform a single Performance SysEx dump. It’s also possible to receive a complete Performance Bank via MIDI. See [“Performance Bank Receive” on page 127](#).

# 7. PANEL REFERENCE

## LFO 1 & 2



LFO stands for Low Frequency Oscillator. An LFO is an oscillator producing waveforms just like an ordinary oscillator, but with a few differences:

- The LFOs are capable of producing waveforms with very low frequency.
- LFOs are normally not used for generating audible frequencies. Instead the output from the LFO is used for modulating, that is controlling, other functions, like for example the main oscillator frequency (vibrato) or the filter frequency (wah-wah).

Nord Lead 3 has separate LFOs for each voice, i.e each LFO group (1 & 2) is in fact 24 separate LFOs. However, if you like you can sync them to act as a single LFO for all voices. The Nord Lead 3 LFOs can also be used in single-cycle mode, acting like simple Envelope Generators. The LFOs can be hard-synched to internal clock and to MIDI Clock as well. You can also choose to restart the LFO on key-presses.

### RATE

The Rate KNOB is used to set the frequency of the LFO. The LED to the upper right of the RATE knob indicates the rate and also, in a way, the waveform.

Range: 33.8 seconds/cycle to 523 Hz

Note that this LED indicates the rate for each of the 24 voices. This means that when you play several notes after one another, it's the rate of the currently triggered LFO that will be indicated. This can be perceived as if the LED flickers as you play the keys, but it's normal.

The rate can be hard-synced to the internal Master Clock or to MIDI Clock. To sync the LFO to clock signal, hold down **SHIFT** and turn the **RATE** knob clockwise. The LED to the right below the **RATE** knob indicates clock sync. To disable, hold down **SHIFT** and turn the **RATE** knob counter-clockwise.

When you sync the LFO to the internal Master Clock or to external MIDI Clock, you can set different periods (clock divisions or multiples) to which to sync the LFO. As soon as you turn the **RATE** knob in Clock sync mode, the **DISPLAY** shows the current period:



Turn the **RATE** knob, in Clock sync mode, to set the division/multiple period.

Periods: 32/1, 16/1, 8/1, 4/1, 2/1, 1/1, 1/2, 1/2T, 1/4, 1/4T, 1/8, 1/8T, 1/16, 1/16T and 1/32

When syncing to external MIDI Clock, the LFOs use MIDI Song Position pointer. This means that if you record in an external sequencer, it will always play back the LFO cycle exactly the way it was recorded - even if you start the sequencer in the middle of the sequence. Please refer to [“Master Clock” on page 117](#) for more info about syncing to internal Master Clock or to MIDI Clock.

When editing the LFO1 or LFO2 Rate parameters, a ‘\*’ or ‘/’ sign and a number is shown next to the parameter name in the **DISPLAY**. This indicates the relationship between the LFO1 and LFO2 Rate settings. This information can be useful if you want to have a specific relationship between the LFO Rates.

The formula is: LFO1 Rate \* x.xx = LFO2 Rate

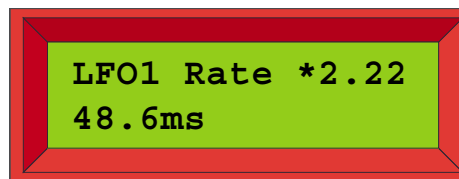

## WAVEFORM

This is used to set the shape of the LFO waveform. Press the **WAVEFORM** button to select one of the following waveforms:

### TRIANGLE

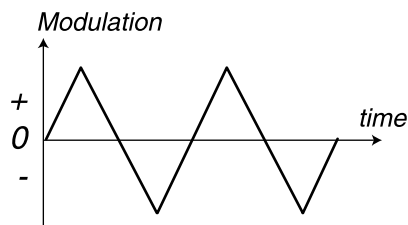

This is suitable for “normal vibrato” effects and for classic pulse width modulation.

### SAWTOOTH

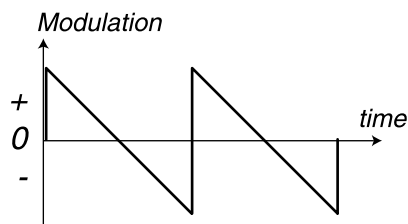

This creates a ramp which can be used for example for auto-repeats when applied to the filter.

### SQUARE

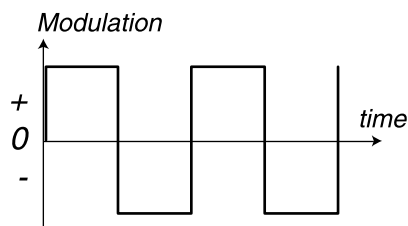

This is a waveform for “abrupt” modulation changes, suitable for trills, distinct tremolos, etc.

### RANDOM

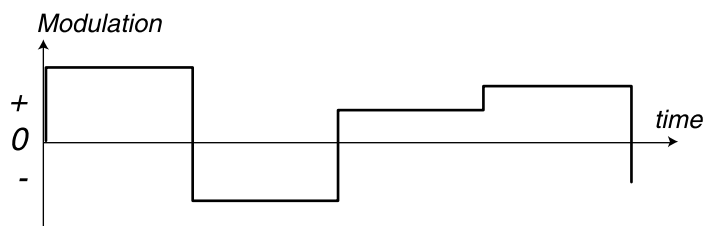

This adds stepped random modulation to the destination.

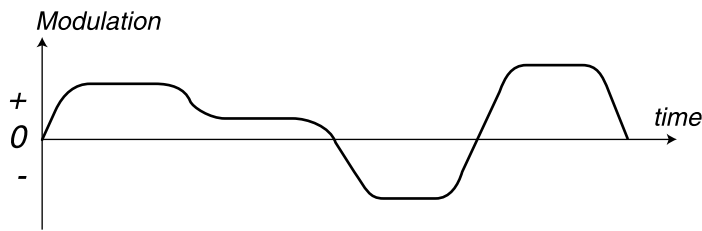
**SMOOTH RANDOM**

This adds smooth random modulation to the destination.

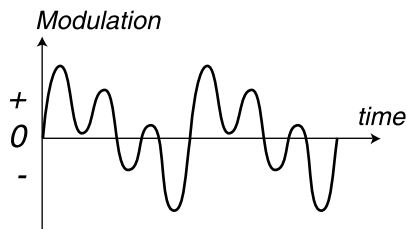
**SPECIAL**

This adds a smooth “triple-peak wave” modulation to the destination. This is mainly useful for rhythmic effects.

**DESTINATION**

This is used to set which parameter(s) the LFO should affect. To the top left of the LED destination indicator there are two circular LEDs, marked 1 and 2. These LEDs indicate which one of the Shape, Filter Frequency and Oscillator Pitch parameters should be affected. If both LEDs (1 and 2) are lit, the LFO controls both parameters of the selected destination “group”. This configuration allows for 12 possible routings for each LFO. Note that the LFO modulation can be different depending on the selected destination and modulation mode. See [“LFO modulation table” on page 48](#).

**OSC (1 AND/OR 2)**

This routes the LFO to the pitch of Oscillator 1 and/or 2. Use the triangle waveform for traditional vibrato effects.

**FILTER (1 AND/OR 2)**

This routes the LFO to the Filter Frequency 1 and/or 2. This can for example be used for wah-wah effects (triangle wave) and for auto repeating sounds (sawtooth wave).

**SHAPE (1 AND/OR 2)**

This routes the LFO to the Shape amount of Oscillator 1 and/or 2. The Shape could be, for example, Pulse Width, FM amount or Oscillator Sync. Please refer to [page 53](#) for details about Shape.

**OSCMOD**

This routes the LFO to the Oscillator Modulation Amount. The Oscillator Modulation could be, for example, FM, Distortion, FilterFM etc. Please refer to [page 70](#) for details about Oscillator Modulation.

**OSCMIX (LFO 1 ONLY)**

This routes LFO 1 to the Osc Mix parameter of the Oscillator section.

**RES (LFO 2 ONLY)**

This routes LFO 2 to the Resonance parameter of the Filter section.

**AMP (LFO 1 ONLY)**

This makes LFO 1 control the amplitude of the signal before routing it to the Amplifier Envelope. Note that the amplitude can be modulated also to a negative value. This will phase shift the signal the same way as in ring modulation.

**PAN (LFO 2 ONLY)**

This routes LFO 2 to control the panning of the audio to output pair **OUT A** and **OUT B** and output pair **OUT C** and **OUT D** (depending on selected Audio Routing mode. See [“Audio Routing” on page 125](#)).

**AMOUNT**

This is used to set to what extent the signal from the LFO should affect the destination. The modulation amount can be either normal or inverted. To switch to Invert amount, hold down **SHIFT** and turn the **AMOUNT** knob clockwise. To revert to normal modulation, hold down **SHIFT** and turn the **AMOUNT** knob counter-clockwise. See [“LFO modulation table” on page 48](#) for details on how different Destinations are affected by normal and inverted modulation.

**ENV/KB SYNC**

Hold down **SHIFT** and press the **WAVEFORM** button once to switch to single-cycle operation. In this mode the LFO act as an Envelope Generator producing only one LFO cycle per key-press. The LED next to the **WAVEFORM** button is lit to indicate that Envelope mode is active.

Hold down **SHIFT** and press the **WAVEFORM** button twice to force the LFO to restart on key-presses. The second LED next to the **WAVEFORM** button is lit to indicate that LFO Keyboard Sync is active. **Note: if you sync the LFO Rate to Master Clock or MIDI Clock, the Envelope and KB Sync modes are automatically disabled.**

See [“LFO modulation table” on page 48](#) for details on how different Destinations are affected in the different modes.

**MONO**

Hold down **SHIFT** and press the **DESTINATION** button to make all LFOs align to each other and act like a single LFO on all voices.

**LFO BEHAVIOR IN MONO MODE****MONO AND FREE-RUNNING LFO**

Every note you play will jump in at the current LFO level. The LFO level will always be the same for all notes you play. If you have assigned the LFO Rate to Keyboard Morph (see [Chapter "5. Morph groups” on page 29](#)) the latest note will determine and change the rate for all held notes.

**MONO AND ENV**

The first note you play will start the LFO cycle at its initial level and the following notes will jump in at the current level of the LFO if you're playing Legato. That is, new notes won't retrigger the LFO if other notes are still held. If you're holding notes throughout the whole LFO cycle, new notes won't be affected



by the LFO at all. A new LFO cycle will start when you press a key after having released all the previous notes. If you have assigned the LFO Rate to Keyboard Morph (see [Chapter "5. Morph groups" on page 29](#)) the latest note will determine and change the LFO cycle time for all held notes.

**MONO AND KB SNG**

The first note you play will start the LFO cycle at its initial level. The following notes will jump in at the current LFO level if you're playing Legato. That is, new notes won't retrigger the LFO if other notes are still held. A new LFO cycle will start when you press a key after having released all the previous notes. If you have assigned the LFO Rate to Keyboard Morph (see [Chapter "5. Morph groups" on page 29](#)) the latest note will determine and change the LFO rate for all held notes. The LFO won't restart but continue at the current level when playing Legato.

### LFO MODULATION TABLE

Below is an LFO modulation table that shows how different destinations are affected by the LFO in different modes. In the examples we use a sawtooth wave as LFO modulation signal but the principle is the same for all waveforms.

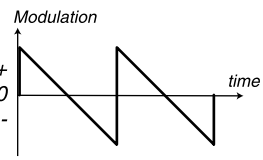
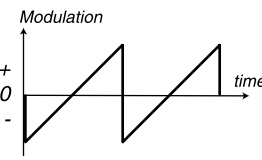
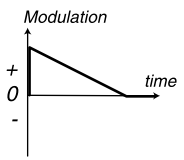
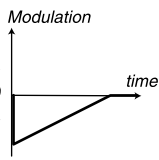
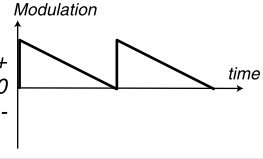
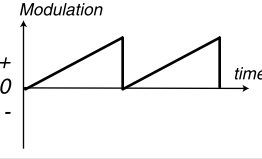
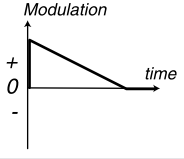
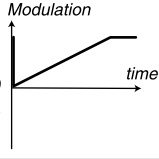
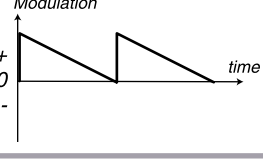
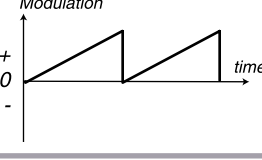
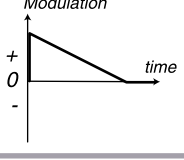
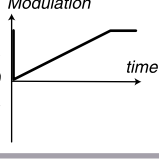
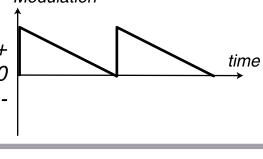
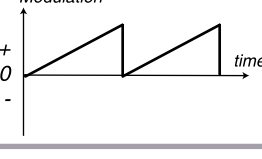
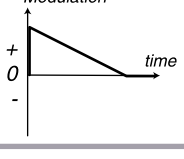
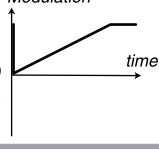
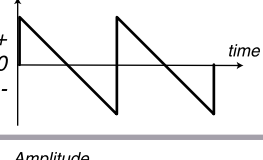
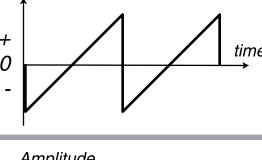
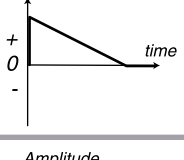
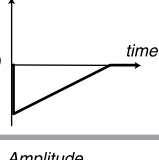
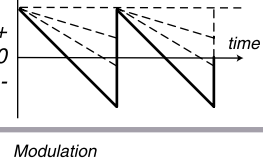
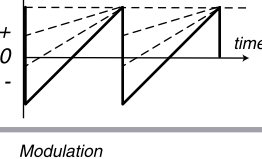
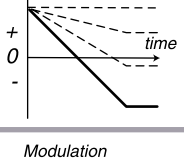
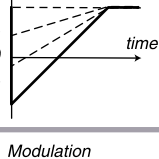
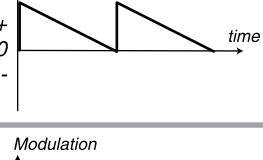
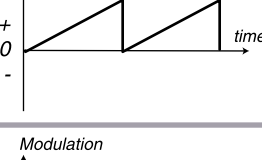
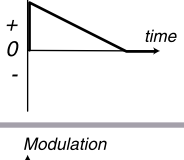
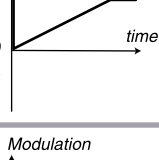
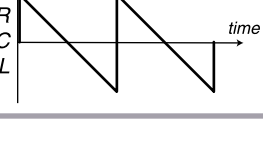
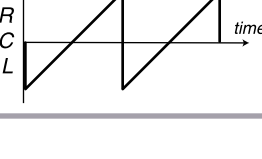
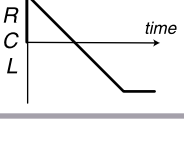
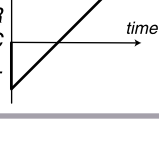
Destination	LFO Normal	LFO Invert	Env Normal	Env Invert
OSC				
FILTER				
SHAPE				
OSCMOD				
OSCMIX				
AMP*				
RES				
PAN				

\* Note that the Modulation always starts at maximum amplitude level for the AMP destination

## MODULATION ENVELOPE



The Modulation Envelope is a simple type of envelope only comprising Attack, Decay/Release and Amount controls. It sends out a control signal that could look like in the figure below.

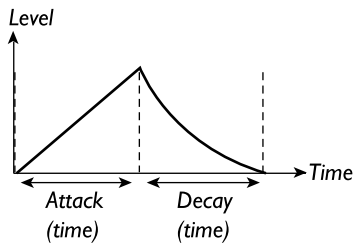

*When you use a positive Amount setting, the Modulation Envelope outputs a control signal that rises to maximum amount at the set Attack time and then immediately falls back to zero at the set Decay time.*

The Modulation Envelope can be used either as an Attack/Decay or Attack/Release envelope or, in Repeat mode, as an LFO with shapable waveform (Attack and Decay times). The Mod Env is always polyphonic, i.e there is a separate Modulation Envelope for each of the 24 voices.

### ATTACK

Set the time it should take for the envelope to reach maximum level after you have pressed a key. Hold down SHIFT and turn the ATTACK knob clockwise to select exponential attack characteristics. Hold down SHIFT and turn the ATTACK knob counter-clockwise to revert to normal attack characteristics.

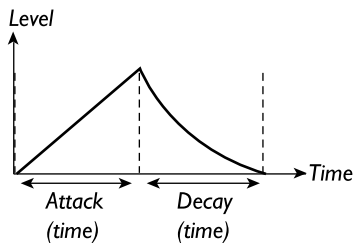

*Linear Attack characteristics*

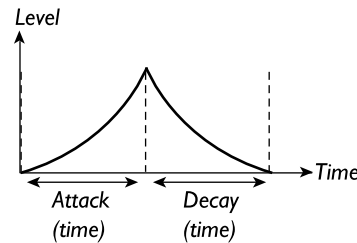

*Exponential Attack characteristics*

Range: 0.5 ms to 45 s.

### DECAY/RELEASE

When the attack phase is over, the envelope drops back to zero level. Use the DECAY knob to set the time this should take.

Instead of having a Decay time, you can switch to have a Release time instead (see figures below). When you press a key, the Attack phase proceeds as usual. When the Attack phase is over the envelope remains

on the maximum (or minimum in Invert mode) Amount for as long as you hold down the key. When you release the key, the Release phase starts and the Amount falls back to zero.

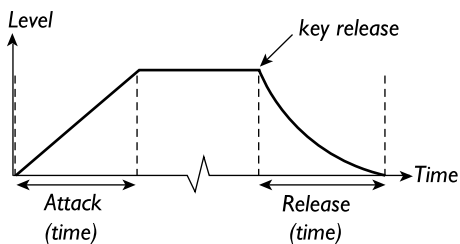

*In Attack/Release mode, the control signal from the Modulation Envelope behaves basically like this*

Hold down **SHIFT** and turn the **DECAY** knob clockwise to select Release time instead of Decay. Hold down **SHIFT** and turn the **ATTACK** knob counter-clockwise to revert to Decay time.

Range: 0.5 ms to 45 s.

## DESTINATION

This is used to set which parameter(s) the Modulation Envelope should affect. To the top left of the LED destination indicator there are two circular LEDs, marked 1 and 2. These LEDs indicate which one of the Shape, Filter Frequency and Oscillator Pitch parameters should be affected. If both LEDs (1 and 2) are lit, the Modulation Envelope controls both parameters of the selected destination “group”. This configuration allows for 12 possible routings of the Modulation Envelope. Note that the Mod Envelope modulation can be different depending on the selected destination and modulation mode. See “[Mod Envelope modulation table](#)” on page 52.

### OSC (1 AND/OR 2)

This routes the Modulation Envelope to the pitch of Oscillator 1 and/or 2. This can for example be used for creating “bleeps” in the beginning of a brass type of sound. Here are a few examples:

If Attack is set to zero, and you have a positive Amount setting, the Oscillator pitch will rise to the Amount setting and then decay down to the initial pitch with the time set with the **DECAY** knob.

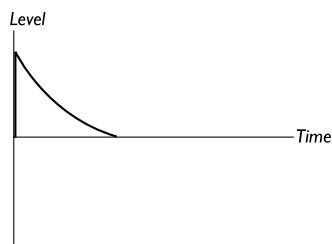

If Amount instead is set to a negative value (in Invert mode), the pitch will fall down to the Amount setting and then rise up to nominal pitch at the set Decay time.

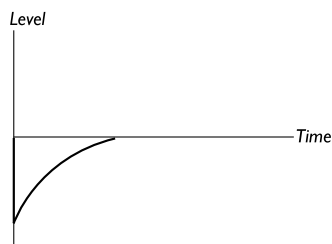

If Attack and Decay are both used and you have a positive Amount setting, the sound will start at normal pitch when you press the key, rise to maximum Amount and then fall back to the initial pitch.

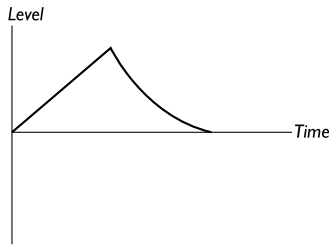

#### **FILTER (1 AND/OR 2)**

This routes the Modulation Envelope to the Filter Frequency1 and/or 2 parameters. This can for example be used for sweeping filter effects and for auto repeating sounds (in Repeat mode described below).

#### **SHAPE (1 AND/OR 2)**

This routes the Modulation Envelope to the Shape amount of Oscillator 1 and/or 2. The Shape could be, for example, Pulse Width, FM amount or Oscillator Sync. Please refer to [page 53](#) for details about Shape.

#### **OSCMOD**

This routes the Modulation Envelope to the Oscillator Modulation Amount. The Oscillator Modulation could be, for example, FM, Distortion, FilterFM etc. Please refer to [page 70](#) for details about Oscillator Modulation.

#### **OSCMIX**

This routes the Modulation Envelope to the Oscillator Mixer.

#### **LFO 1**

This routes the Modulation Envelope to the LFO1 Amount parameter. This can for example be used for slowly introducing the LFO1 modulation. To make the LFO1 Amount remain at a certain level when you hold down a key, set the Modulation Envelope in Attack/Release mode (see above).

### **AMOUNT**

Set to what degree the Modulation Envelope should affect the destination. The modulation amount can be either positive or inverted. To switch to inverted amount, hold down **SHIFT** and turn the **AMOUNT** knob clockwise. To revert to positive modulation, hold down **SHIFT** and turn the **AMOUNT** knob counter-clockwise. Note that the Mod Envelope modulation can be different depending on the selected destination and modulation mode. See [“Mod Envelope modulation table” on page 52](#).

**REPEAT**

Hold down SHIFT and press the DESTINATION button to force the Modulation Envelope to restart directly after the Decay phase. This creates a kind of LFO with “shapable” waveform where you can change the waveshape and cycle time by adjusting the Attack and Decay times.

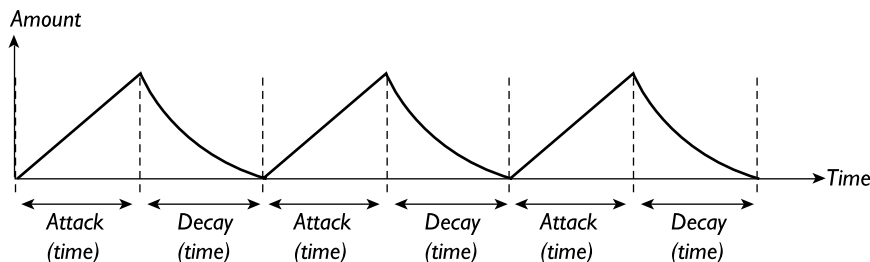

Note that you cannot use the Modulation Envelope in Repeat mode when you use Attack/Release mode. If you activate the Repeat function in Attack/Release mode, the Attack/Release takes precedence and the Repeat function won't have any effect until you switch back to Attack/Decay mode.

**MOD ENVELOPE MODULATION TABLE**

Below is the Mod Envelope modulation table that shows how different destinations are affected by the Mod Envelope in different modes. 'A/D' stands for 'Attack/Decay' mode and 'A/R' for 'Attack/Release' mode. The graphs for A/D Normal and A/D Invert modes are also true when you use Repeat mode, only the waveform is then repeated over and over again until you release the key(s).

Destination	A/D Normal	A/D Invert	A/R Normal	A/R Invert
OSC				
OSCMIX				
FILTER, SHAPE, OSCMOD, LFO1				

## OSCILLATOR 1 & 2



### WAVEFORM SELECTOR, SHAPE AND SYNC

Since the different waveforms are affected quite differently depending on the Shape settings, we will describe each waveform with its unique characteristics in separate paragraphs. Oscillator Sync of the different waveforms are described in detail on [page 60](#). When we refer to the WAVEFORM SELECTOR and SHAPE knobs, we mean either of the WAVEFORM SELECTOR buttons or SHAPE1 and SHAPE2 knobs.

Select one of six basic waveforms for Oscillator 1 and 2 with the WAVEFORM SELECTOR buttons.

#### SAWTOOTH

The sawtooth wave contains all harmonics and is the richest of the available waveforms. It is suitable for all sorts of sounds.

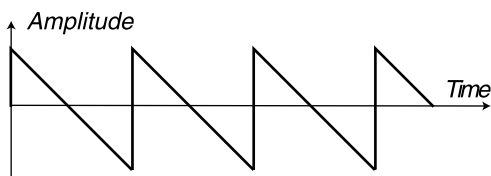

*The sawtooth signal shape*

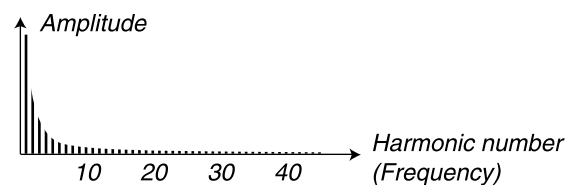

*The sawtooth signal frequency spectrum*

The SHAPE knob does not have any effect on the sawtooth wave. Hold down SHIFT and press the WAVEFORM SELECTOR button to sync the sawtooth wave. In sync mode a “hidden” sync oscillator is activated and controls the main pitch of the signal. In sync mode the SHAPE knob controls the synced oscillator’s frequency. As you change the Shape1 value you get drastic changes in timbre - the typical “synced sound”. Please refer to [“Oscillator Sync” on page 60](#) for a more detailed explanation of oscillator sync.

**PULSE**

The pulse wave contains only odd harmonics at 50% pulse width (square wave). This waveform is special in that its harmonic content can be varied continuously, by adjusting the pulse width.

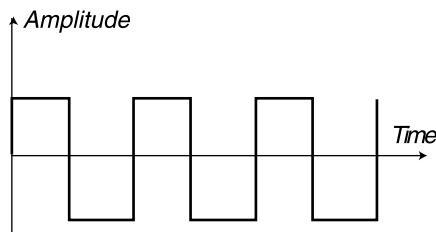

*The pure square wave: a pulse wave with 50% pulse width*

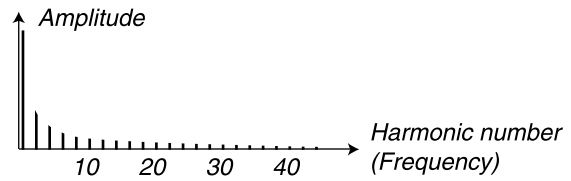

*The frequency spectrum of a pure square wave. The signal contains only odd harmonics*

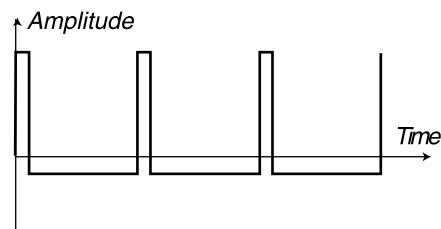

*The pulse wave at 10% pulse width*

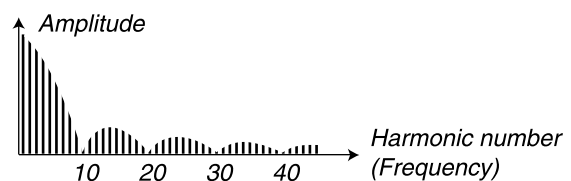

*The frequency spectrum at 10% pulse width. Now, also even harmonics are gradually introduced making the sound "sharper" but also "thinner"*

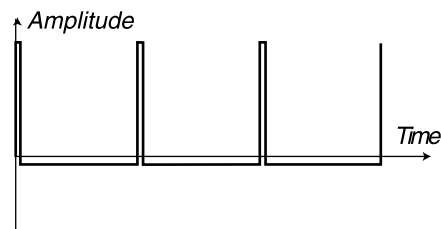

*The pulse wave at 5% pulse width*

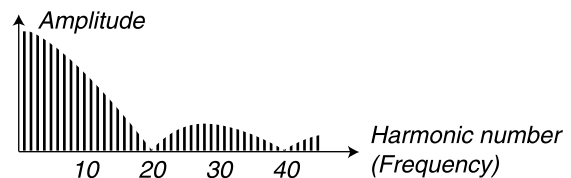

*The narrower the pulse width, the more harmonics are present in the frequency spectrum*

The **SHAPE** knob controls the pulse width of the pulse wave, from 50% (square wave) to 1%. If you for example modulate the Shape value from an LFO, you can get very nice "synthesized strings". This waveform is suitable for many type of sounds and has a more "hollow" character than the Sawtooth wave. Hold down **SHIFT** and press the **WAVEFORM SELECTOR** button to sync the pulse wave. In sync mode a "hidden" sync oscillator is activated and controls the main pitch of the signal. In sync mode the **SHAPE** knob controls the synced oscillator's frequency. As you change the Shape value you get drastic changes in timbre - the typical "synced sound". Please refer to "[Oscillator Sync](#)" on page 60 for a more detailed explanation of oscillator sync.

**TRIANGLE**

The triangle waveform has only odd and not very strong harmonics. It is suitable for flute sounds and similar. The **SHAPE** knob affects the triangle wave according to the figure to the left below, i.e. the triangle



wave's peaks gets "cut off" gradually with increased Shape value. If you for example modulate the Shape value from an LFO, you get a very nice soft timbre change.

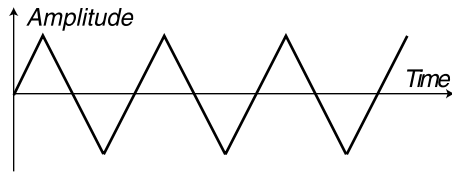

The triangle wave

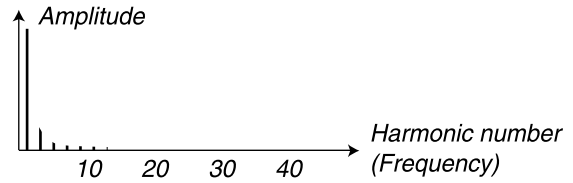

The frequency spectrum of the triangle wave contains only odd harmonics at fairly low levels

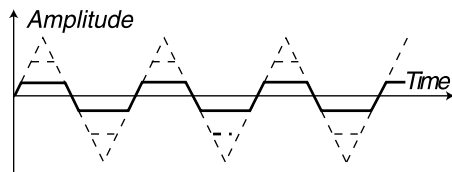

The triangle wave transforms into a "hybrid" trianglesquare wave the more you increase the Shape value

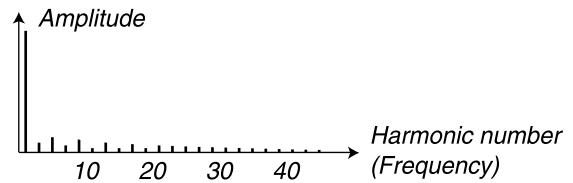

The relationship in amplitude between the odd harmonics change as you increase the Shape value

Hold down SHIFT and press the WAVEFORM SELECTOR button to sync the triangle wave. In sync mode a "hidden" sync oscillator is activated and controls the main pitch of the signal. In sync mode the SHAPE knob controls the synced oscillator's frequency. As you change the Shape value you get drastic changes in timbre - the typical "synced sound". Please refer to "Oscillator Sync" on page 60 for a more detailed explanation of oscillator sync.

**SINE**

The sine wave is the simplest waveform there is. It has no additional harmonics. It is suitable for very soft sounds or for use with FM. In Nord Lead 3 the sine wave also has adjustable feedback which can be used to add harmonics to the signal.

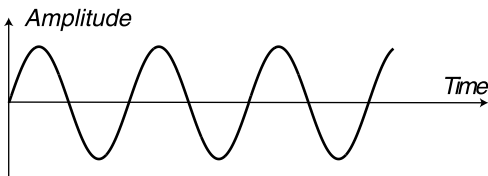

The pure sine wave with no additional harmonics

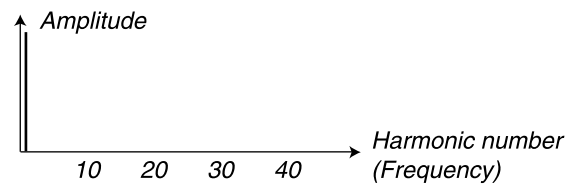

The frequency "spectrum" of a sine wave: only the fundamental frequency is present

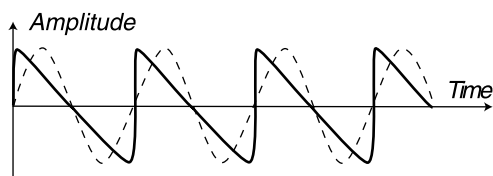

The sine wave gets more harmonics the more you increase the Shape value. At maximum feedback the signal almost gets sawtooth wave characteristics

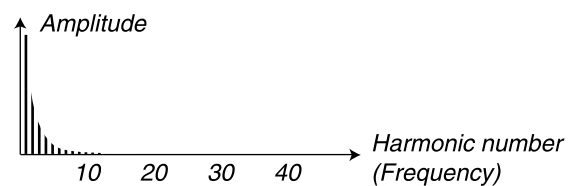

The more you increase the feedback (Shape value), the more harmonics become present.

The **SHAPE** knob controls the amount of internal feedback of the sine wave. This is actually the simplest form of FM - one sine wave oscillator frequency-modulating itself. The practical result of this self-modulation is more harmonics the more feedback you add. With maximum feedback you get a waveform very similar to a sawtooth wave. Hold down **SHIFT** and press the **WAVEFORM SELECTOR** button to sync the sine wave. In sync mode a “hidden” sync oscillator is activated and controls the main pitch of the signal. In sync mode the **SHAPE** knob controls the synced oscillator’s frequency. As you change the Shape value you get drastic changes in timbre - the typical “synced sound”. Please refer to [“Oscillator Sync” on page 60](#) for a more detailed explanation of oscillator sync.

### NOISE (OSCILLATOR 1)

With noise selected, the oscillator produces noise rather than a pitched waveform. The color (frequency content) of the noise can be changed with a 12 dB/octave lowpass filter controlled by the **SHAPE1** knob. The further you turn the **SHAPE1** knob clockwise, the brighter the noise. All full level, the frequency content is very close to that of white noise (where all frequencies are represented with equal energy). Note that the sound of the noise is also affected by the Frequency settings of the Filter group (as all other sound from the Nord Lead 3). If the Filter Frequency is turned down, adjusting the Noise color might not have the expected effect.

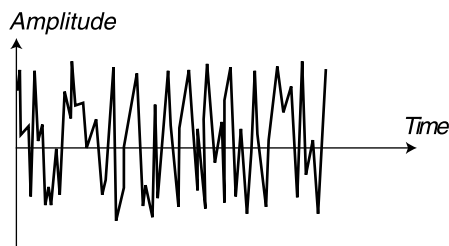

*‘White noise’ contains all frequencies at equal energy levels*



*With the **SHAPE1** knob you control the cutoff frequency of the built-in 12 dB/octave lowpass filter for the noise. At full Shape1 amount you get white noise and at lower amounts the noise becomes “colored”*

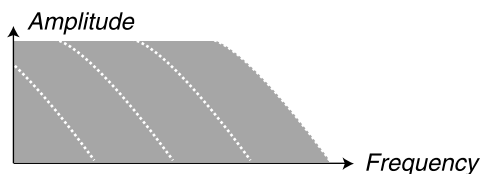

Traditionally, noise in synthesizers can have different “colors”. White noise, for example, contains all frequencies at equal energy levels, as discussed above. Pink noise is another well-known noise “color”. Actually, pink noise is white noise with a 3 dB/octave lowpass filter applied. In practice, pink noise is perceived as a slightly less bright noise than white noise. The practical effect of pink noise is very easy to achieve by simply lowering the Shape1 value slightly from its maximum value.

### SYNCED NOISE (OSCILLATOR 1 OR 2)

Hold down **SHIFT** and press the **WAVEFORM SELECTOR** button to activate a special function in Nord Lead 3 called ‘synced noise’. This will produce very special signals with non-transposed formant spectrum with strong “body resonance” characteristics. The reason ‘synced noise’ works at all is that it’s the same series of frequencies that are synced (repeated over and over). In a traditional analog system this function wouldn’t work since the noise is totally random. In ‘synced noise’ mode the **SHAPE** knob works as a “waveform se-

lector”. Turning the knob will change the harmonic content of the sound. The selection is not continuous but stepped - like switching between “ordinary” waveforms.



*Non-synched white noise contains all frequencies at equal levels.*

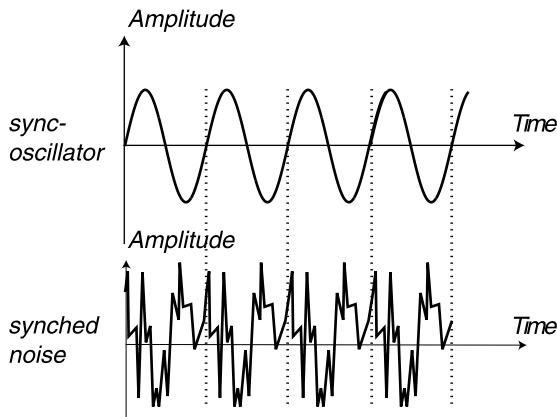

*The synched noise repeats itself each time the sync oscillator starts a new period*

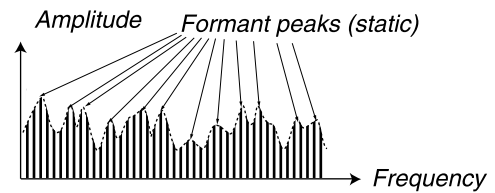

*Synched noise produces a special type of digital waveforms with static “body resonance” characteristics*

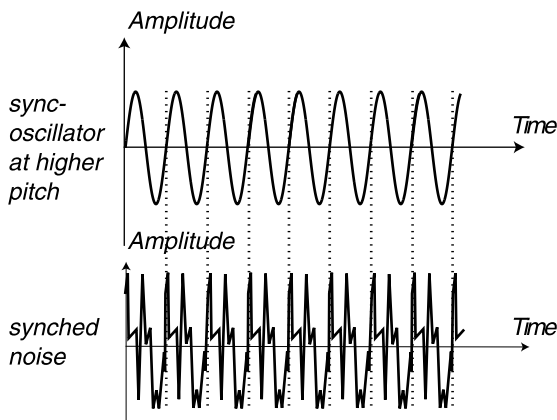

*Here, the noise signal is the same as before, only now the sync oscillator has higher pitch*

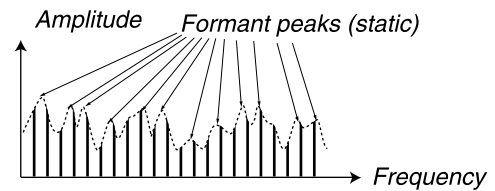

*Synched noise at higher pitch. As you can see, the formant peaks are the same even though the pitch is higher*

**DUAL SINE (OSCILLATOR 1)**

The Dual Sine is a special feature of Nord Lead 3. Basically the Dual Sine signal of Oscillator 1 is a combination of two sine waves with one octave separation in pitch. The two sine waves can also be used as

base for 2 or 4 operator FM synthesis described below. Below is a block diagram of how the signals are routed when using the Dual Sine mode of Oscillator 1:

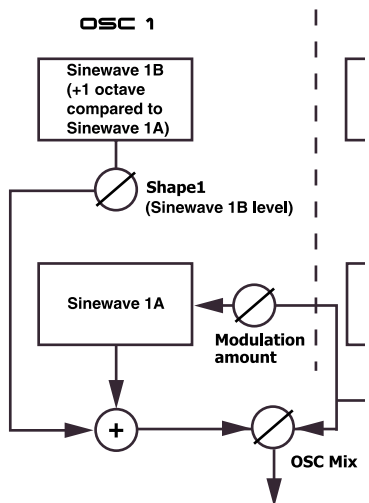

By turning the SHAPE1 knob you gradually introduce and increase the level of sine wave 1B (the one 1 octave above).

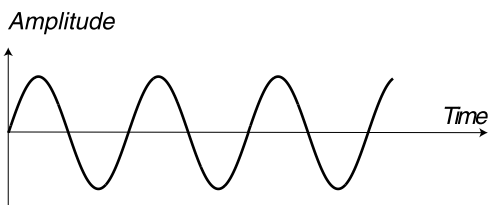

Sine wave 1A

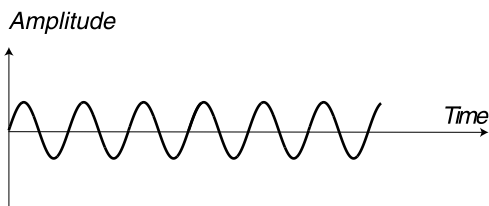

Sine wave 1B one octave above

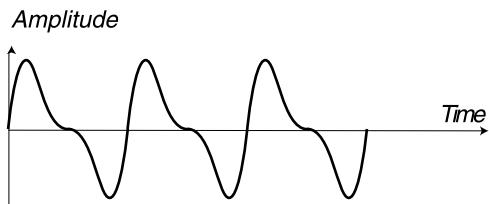

When you increase the Shape1 value, you gradually increase the level of the sine wave 1B (1 octave above) and the resulting signal can look like this (depending on the actual phase relationship)

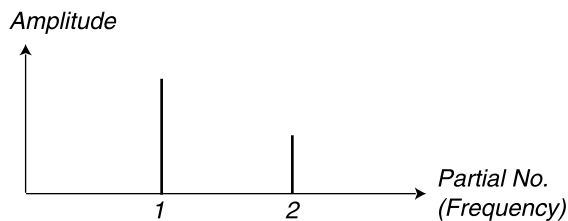

**DUAL SINE FM (OSCILLATOR 1)**

Hold down SHIFT and press the WAVEFORM SELECTOR button for Oscillator 1 to activate Dual Sine FM. Now you have a 2 operator FM engine with sine wave 1A as Carrier and sine wave 1B as Modulator at the fixed frequency relationship 1:1 (not 1 octave separation in FM mode!). Below is a block diagram of how the signals are routed when using the Dual Sine FM mode of Oscillator 1:

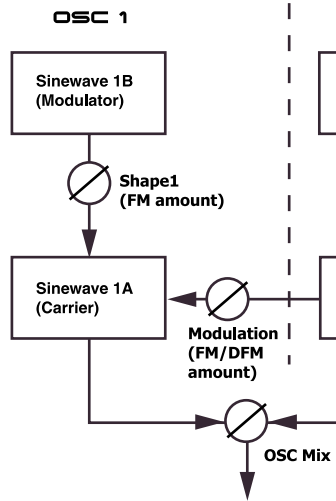

Oscillator 1 in Dual Sine FM mode, with sine wave 1A (Carrier) and sine wave 1B (Modulator) at the fixed frequency relationship 1:1.

Turn the SHAPE1 knob to change the Modulator amplitude and thus the frequency modulation amount.

By turning the SHAPE1 knob you increase the sine wave 1B (Modulator) amplitude and thus the frequency content of the signal. FM can be used for creating a wide variety of sounds, especially “metallic” and “bell-like” sounds.

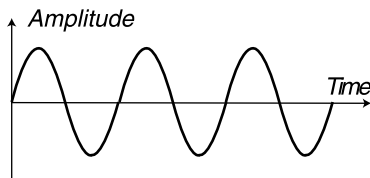

Sine wave 1A (Carrier)

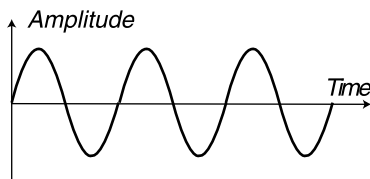
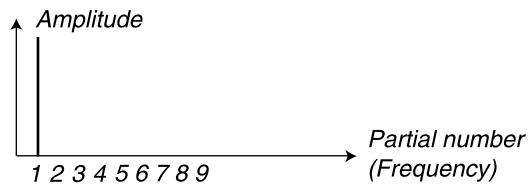

Sine wave 1B (Modulator) at the same frequency as sine wave 1A (Carrier)

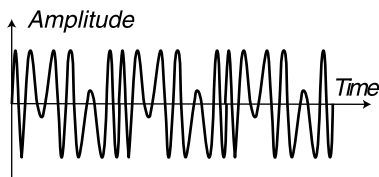
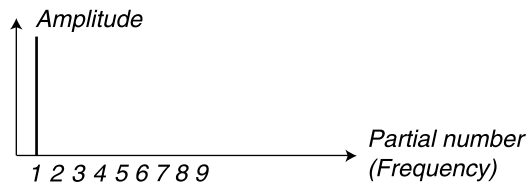

The resulting frequency modulated signal at a fairly high modulation amount.

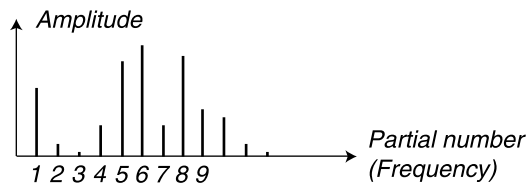

The resulting signal's frequency spectrum when modulating sine wave 1A (Carrier) with sine wave 1B (Modulator). The distance between the peaks is the same as sine wave 1B's (Modulator) frequency

## OSCILLATOR SYNC

On Nord Lead 3 two oscillators can be *synchronized*. In practice Oscillator Synchronization means that you use the signal from one oscillator to restart another oscillator. This also means that you will only get an output signal from one oscillator, even though you use two. This is why Nord Lead 3 has a “hidden” sync oscillator in each oscillator group. This way you don’t have to sacrifice one audio oscillator just to sync another. In Nord Lead 3 this also means that you can have two synched audio oscillators running at the same time! Below is a block diagram of how the signals are routed when using Oscillator Sync in both oscillators:

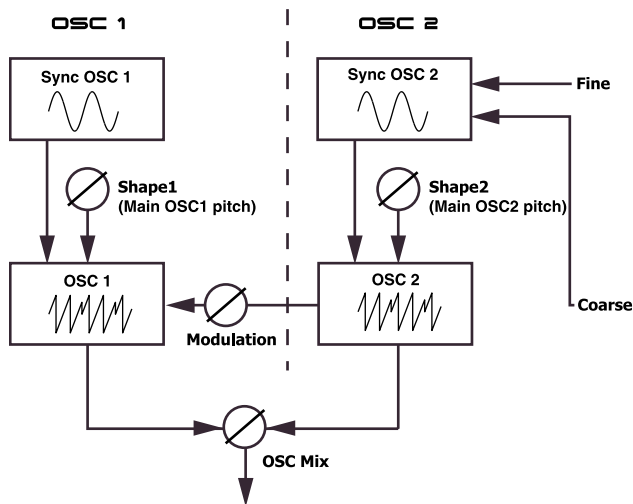

If you synchronize an Oscillator to the sync-oscillator, the Oscillator will start over with a new period of the waveform, each time the sync-oscillator does so. If the Oscillator then has a higher frequency than the sync-oscillator, it will get a complex waveform that depends both on its own pitch and on that of the sync-oscillator.

Example 1: a sawtooth wave synched by a sync oscillator. The sawtooth wave is restarted every time the sync oscillator begins a new cycle. The resulting signal gets deep resonance in its harmonics.

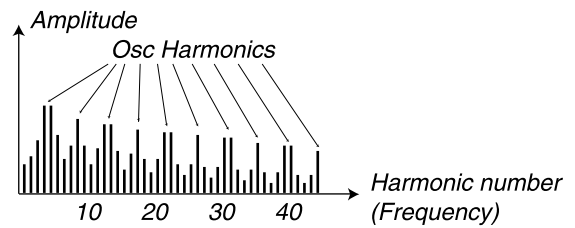
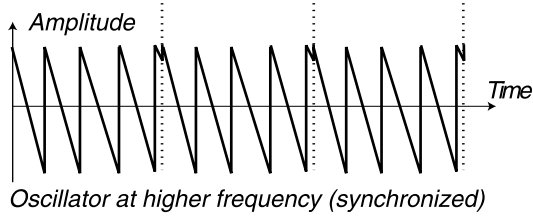
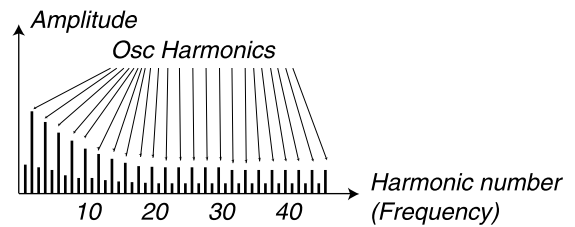
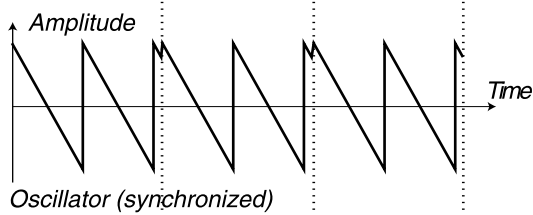
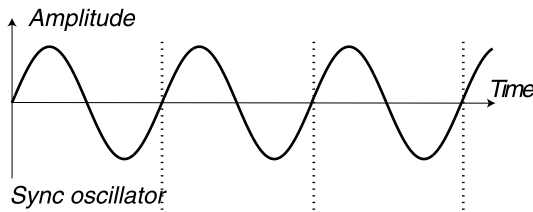
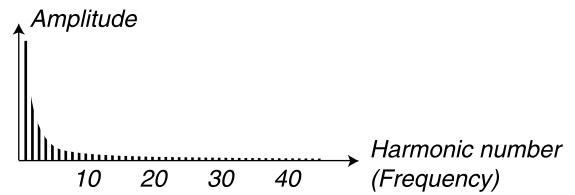
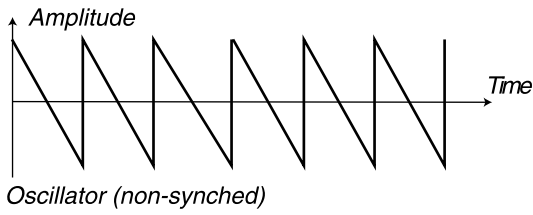

*Example 2: a square wave synched by a sync oscillator. The square wave is restarted every time the sync oscillator begins a new cycle. The resulting signal gets deep resonance in its harmonics.*

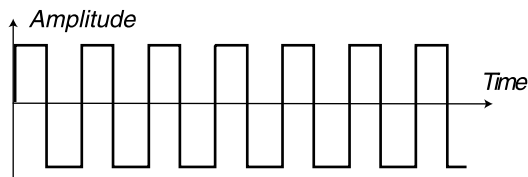

Oscillator (non-synched)

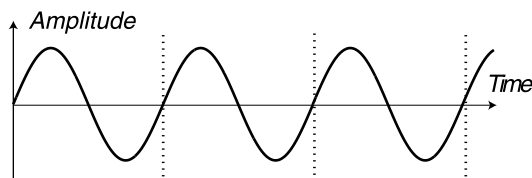
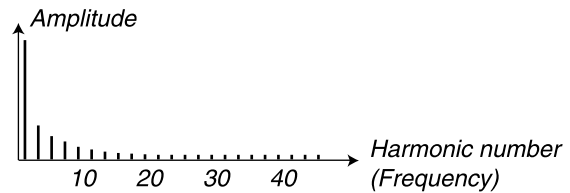

Sync oscillator

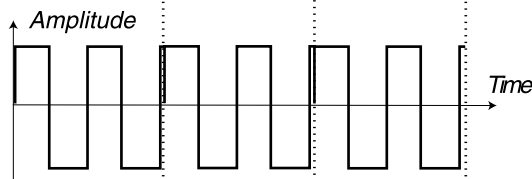

Oscillator (synchronized)

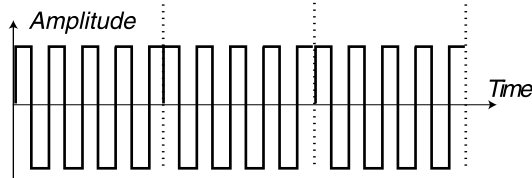
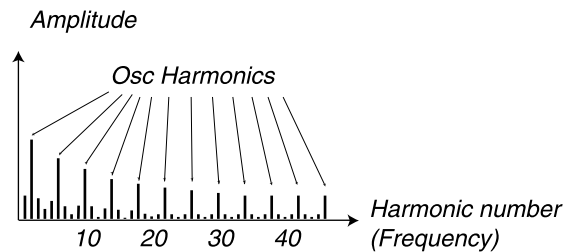

Oscillator at higher frequency (synchronized)

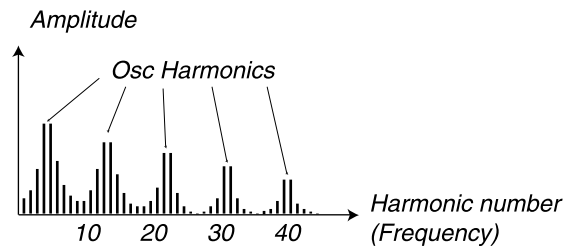

When sync is applied, the basic pitch of the Oscillator is locked to that of the sync-oscillator. If you change the pitch of the sync-oscillator you will affect the basic pitch of both oscillators. Furthermore, when you vary the pitch of the synchronized Oscillator, this will be perceived as a change in timbre, rather than in pitch. This leads to a signal with a frequency spectrum with deep resonance in the Oscillator's harmonics.

Hold down **SHIFT** and press the **WAVEFORM SELECTOR** button to sync the wave. Oscillator Sync can be used with all waveforms except in Dual Sine mode. In sync mode the “hidden” sync oscillator is activated and controls the main pitch of the signal. In sync mode the **SHAPE** knob controls the synched oscillator's pitch. As you change the Shape value you get drastic changes in timbre - the typical “synched sound”.

Tip! When using Oscillator Sync, it can be very useful to have the Shape amount(s) modulated from any of the LFOs in Nord Lead 3. This will generate a signal with continuously varied harmonic content.



## OSCILLATOR 2



### WAVEFORM SELECTOR, SHAPE AND SYNC

The four first waveforms are exactly the same types as those of Oscillator 1. Please refer to the descriptions of Oscillator 1's waveforms.

#### SAWTOOTH

See the description of Oscillator 1's "Sawtooth" on page 53.

#### PULSE

See the description of Oscillator 1's "Pulse" on page 54.

#### TRIANGLE

See the description of Oscillator 1's "Triangle" on page 54.

#### SINE

See the description of Oscillator 1's "Sine" on page 55.

#### NOISE (OSCILLATOR 2)

With noise selected, the oscillator produces noise rather than a pitched waveform. The noise of Oscillator 2 has more control possibilities than that of Oscillator 1. With the FINE knob you control the filter mode of the built-in noise filter. At 8 o'clock position you get a lowpass filter, at 12 o'clock position you get a band pass filter and at 4 o'clock position you have a high pass filter. The filter modes are also illustrated in blue color around the FINE knob. With the COARSE knob you control the cutoff/center frequency for the noise filter and with the SHAPE2 knob you control the resonance of the noise filter.

Note that the sound of the noise is also affected by the Frequency settings of the Filter group (as all other sound from the Nord Lead 3). If the Filter Frequency is turned down, adjusting the Noise color might not have the expected effect.

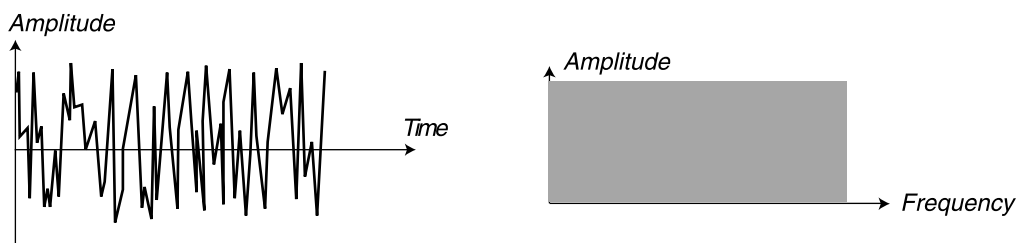

*'White noise' contains all frequencies at equal energy levels*

### DUAL SINE (OSCILLATOR 2)

The Dual Sine is a special feature of Nord Lead 3. Basically the Dual Sine signal of Oscillator 2 is a combination of two sine waves with selectable pitch separation. The two sine waves can also be used as base for 2 or 4 operator FM synthesis described below. Below is a block diagram of how the signals are routed when using the Dual Sine mode of Oscillator 2:

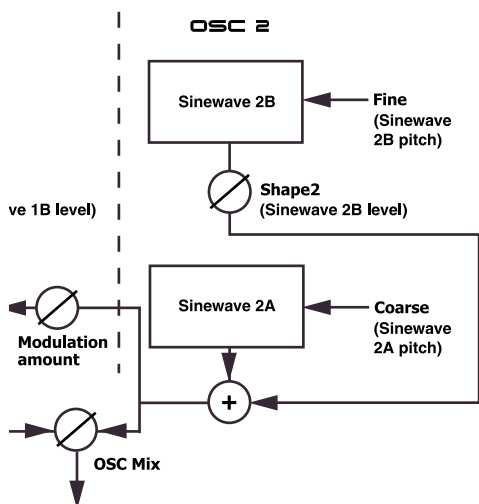

Dual Sine in Oscillator 2 provides more control functionality compared to that of Oscillator 1. When you enter Dual Sine mode in Oscillator 2, the 3-character LED DISPLAY switches to show sine wave 2A's pitch to the left of the dot and sine wave 2B's pitch to the right. See more about the LED DISPLAY on [page 67](#).

By turning the SHAPE2 knob you gradually introduce and increase the level of sine wave 2B. You select sine wave 2A's pitch by turning the COARSE knob. Turn the FINE knob to select the pitch for sine wave

2B relative to sine wave 2A. To be able to directly reach harmonic pitch values for sine wave 2B, press the PARTIAL NO button.

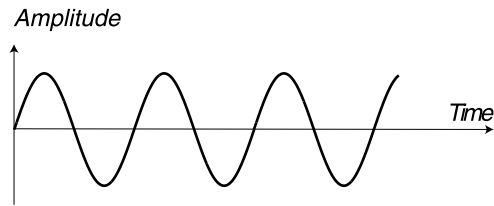

Sine wave 2A (at selectable pitch)

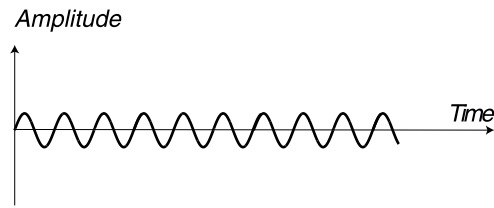
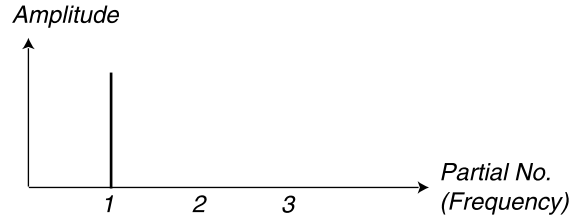

Sine wave 2B (at selectable pitch)

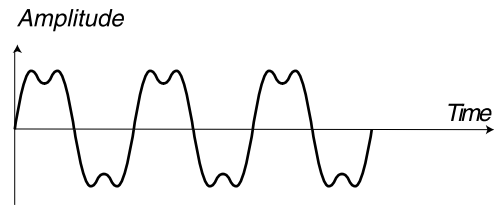
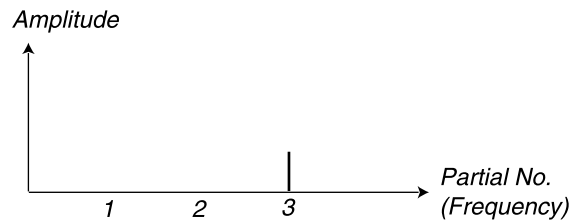

When you increase the Shape2 value, you gradually increase the level of sine wave 2B and the resulting signal could look like this

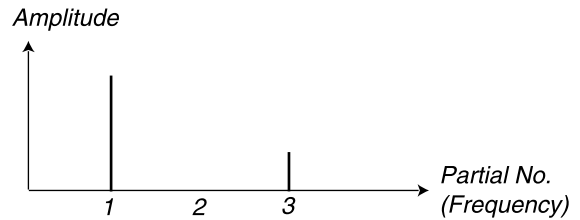

**DUAL SINE FM (OSCILLATOR 2)**

Hold down SHIFT and press the WAVEFORM SELECTOR button for Oscillator 2 to activate Dual Sine FM. Now you have a 2 operator FM engine with sine wave 2A as Carrier and sine wave 2B as Modulator.

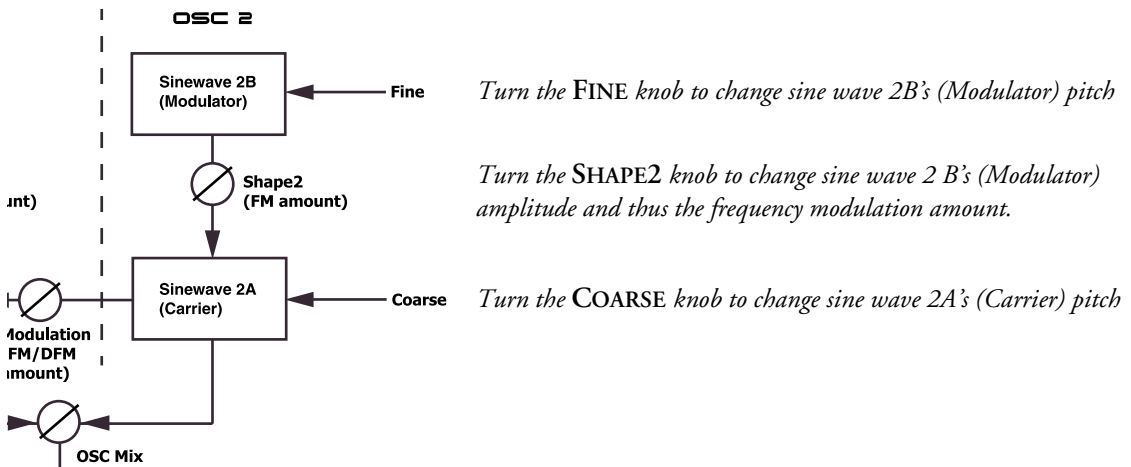

By turning the SHAPE2 knob you increase sine wave 2B's (Modulator) amplitude and thus the frequency modulation of the signal. FM can be used for creating a wide variety of sounds, especially "metallic" and "bell-like" sounds.

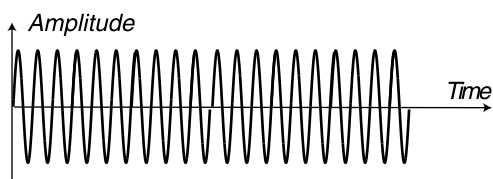

*Sine wave 2A (Carrier) at selectable pitch*

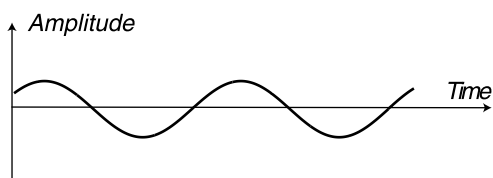
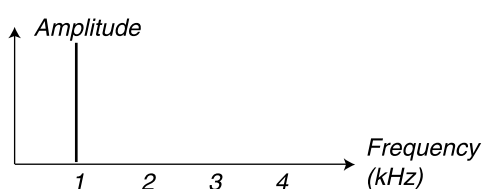

*Sine wave 2B (Modulator) at selectable pitch*

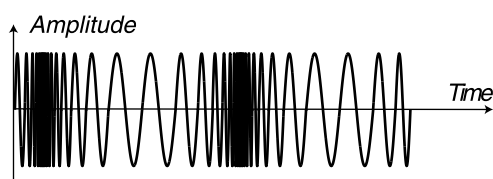
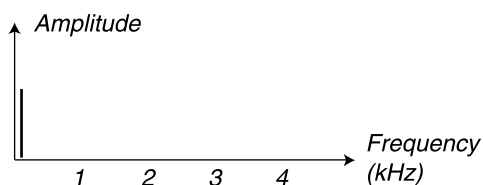

*The resulting signal when modulating sine wave 2A (Carrier) with sine wave 2B (Modulator): a signal that continuously changes in frequency*

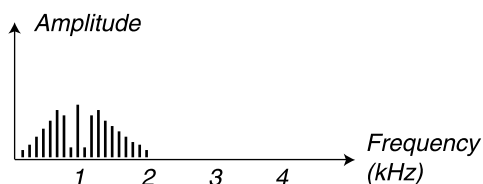

Dual Sine FM in Oscillator 2 provides more control functionality compared to that of Oscillator 1. When you enter Dual Sine FM mode in Oscillator 2, the 3-character LED DISPLAY switches to show sine wave 2A's (Carrier) pitch to the left of the dot and sine wave 2B's (Modulator) pitch value to the right. See [page 67](#) for more info about the LED DISPLAY.

You select the sine wave 2A (Carrier) pitch by turning the COARSE knob. Turn the FINE knob to select the pitch for sine wave 2B (Modulator). To be able to directly reach harmonic pitch values for sine wave 2B (Modulator), press the PARTIAL NO button.

### **KBT OFF**

Hold down SHIFT and press the PARTIAL NO button to switch off the Oscillator 2 keyboard tracking. When keyboard tracking is turned off, Oscillator 2 will always play the same pitch regardless of where on the keyboard you play. This can be useful when FM or Ring Modulation are used, to get inharmonic sounds with very varying timbre across the keyboard, or for special effects and percussion sounds, which are supposed to sound the same all across the keyboard.

You set the Oscillator 2 pitch with the COARSE and FINE knobs described below.

## FINE TUNE

The FINE knob is for fine tuning Oscillator 2. The Fine parameter operates within one semitone, +/- 0.5 semitones. If you set Oscillator 1 and 2 to equal volume (see Osc Mix below) and Oscillator 2 to '0' Coarse tune value, and raise or lower the Fine parameter slightly, the slight difference in pitch will make the sound "richer".

Range: +/- 0.5 semitones in 128 steps.

## COARSE TUNE

The COARSE knob is used to adjust the coarse tuning of Oscillator 2, relative to Oscillator 1. The range is from 5 octaves below Oscillator 1 to 5 octaves above Oscillator 1, i.e. 10 octaves. If you press the PARTIAL NO button, you can set the Oscillator 2 coarse tune in partials rather than in semitones. To aid you in setting the value, the LED DISPLAY shows the semitone/partial value relative to the Oscillator 1 pitch. Range: +/- 5 octaves in steps of 1 semitone or in steps of partials.

Note: Depending on the Oct Shift setting (see [page 111](#)), you might reach frequencies that aren't audible.

## THE PITCH LED DISPLAY



The LED DISPLAY in the Oscillator section is used to display information pertaining to the frequency/frequencies of Oscillator 2. This can be displayed in a number of different ways:

### DISPLAY OF SEMITONES FOR WAVEFORMS 1-5

This is the default way of displaying the Oscillator 2 pitch when the PARTIAL NO. and KBT OFF HZ functions are not activated. The semitone value is displayed the same way for every waveform except for Dual Sine and Dual Sine FM. The semitone figure is relative to the pitch of Oscillator 1. In the pictures below, the middle C (C4) note is our reference note. If you turn the COARSE knob the pitch and LED DISPLAY will increment or decrement in steps of 1 semitone. The range is -63 to 63 semitones in steps of 1 semitone.

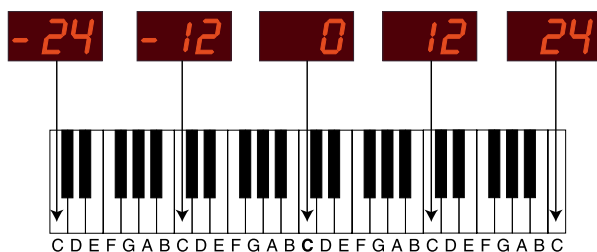

### DISPLAY OF PARTIALS FOR WAVEFORMS 1-5

When the PARTIAL NO. function is activated the LED DISPLAY switches to show partials instead of semitones. The partial value is displayed the same way for every waveform except in Dual Sine mode. The partial figure is relative to the pitch of Oscillator 1. In the picture below, the middle C (C4) note is our

reference note. If you turn the COARSE knob the pitch and LED DISPLAY will increment or decrement in steps of 0.5 partials until it reaches the 10th or -10th partial. Beyond the 10th or -10th partial the increment/decrement is in steps of 1 partial. The total range is -16 to 94 partials

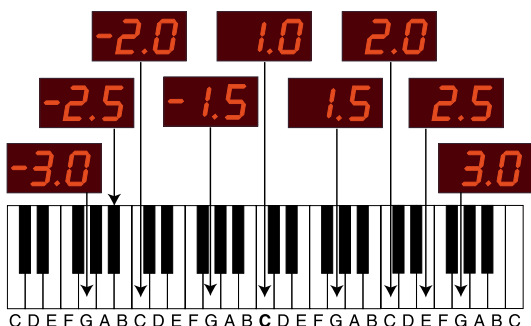

*When the partial number gets below -10 or above 10 partials, the decrement/increment is in steps of 1 partial instead of 0.5 partials*

*(Partials are multiples or divisions of a fundamental pitch. Partial no. 2 is twice the fundamental pitch and so on.)*

**DISPLAY OF SEMITONES IN DUAL SINE AND DUAL SINE FM MODE**

This is the default way of displaying the semitone values in Dual Sine mode when the PARTIAL NO. and KBT OFF HZ functions are not activated. The leftmost semitone figure is relative to the pitch of Oscillator 1. The displayed semitone value to the left in the LED DISPLAY pertains to sine wave 2A, which is also the Carrier when in Dual Sine FM mode. The figure to the right of the dot in the LED DISPLAY is the semitone value of sine wave 2B, which is also the Modulator when in Dual Sine FM mode. The sine wave 2B/Modulator value is also relative to the pitch of Oscillator 1. In the pictures below, the middle C (C4) note is our reference note. When you turn the COARSE knob the LED DISPLAY will increment or decrement the sine wave 2A/Carrier value in steps of 1 semitone. When you turn the FINE knob the LED DISPLAY will increment or decrement the sine wave 2B/Modulator value in steps of 1 semitone. The range for sine wave 2A/Carrier is -1 to 9 semitones in steps of 1 semitone. The range for sine wave 2B/Modulator is -19 to 99 semitones in steps of 1 semitone.

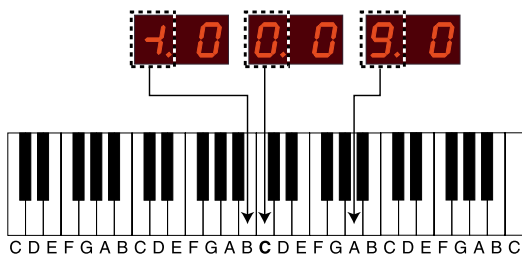

*With the COARSE knob you control the sine wave 2A/Carrier semitone value relative to the pitch of Oscillator 1.*

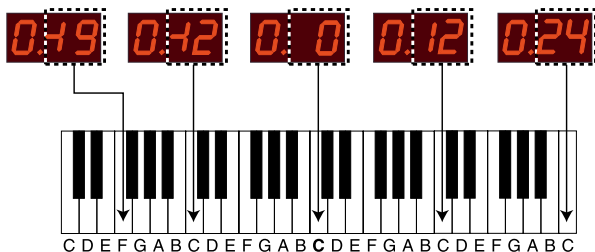

*With the FINE knob you control the sine wave 2B/Modulator semitone value relative to the pitch of Oscillator 1.*

**DISPLAY OF PARTIALS IN DUAL SINE AND DUAL SINE FM MODE**

When the PARTIAL NO. function is activated in Dual Sine mode the LED DISPLAY switches to show partials instead of semitones. The leftmost partial figure is relative to the pitch of Oscillator 1. The displayed semitone value to the left in the LED DISPLAY pertains to sine wave 2A, which is also the Carrier

when in Dual Sine FM mode. The figure to the right of the dot in the LED DISPLAY is the partial value of the semitone value of sine wave 2B, which is also the Modulator when in Dual Sine FM mode. The sine wave 2B/Modulator partial value is relative to the pitch of Oscillator 1. In the pictures below, the middle C (C4) note is our reference note. When you turn the COARSE knob the LED DISPLAY will increment or decrement the sine wave 2A/Carrier value in steps of 1 partial. When you turn the FINE knob the LED DISPLAY will increment or decrement the sine wave 2B/Modulator value in steps of 0.5 partials until it reaches the 10th or -10th partial. Beyond the 10th or -10th partial the increment/decrement is in steps of 1 partial. The range for sine wave 2A/Carrier is 0 (-1 octave) to 9 partials in steps of 1 partial. The range for sine wave 2B/Modulator is -16 to 94 partials in steps of 0.5 or 1 partial.

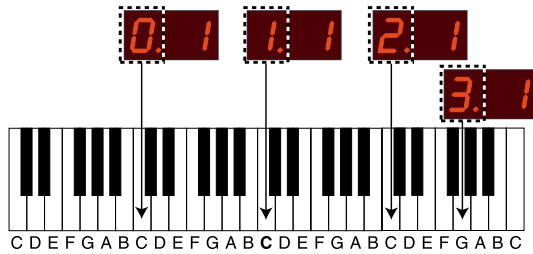

*With the COARSE knob you control the sine wave 2A/Carrier partial value relative to the pitch of Oscillator 1*

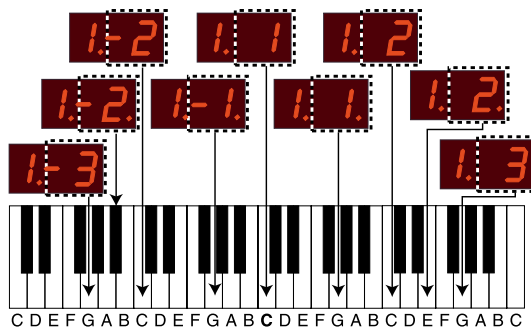

*With the FINE knob you control the sine wave 2B/Modulator partial value relative to the pitch of Oscillator 1*



*When the sine wave 2B/Modulator partial number is within the range -9.5 to 9.5 partials, the dot to the right in the LED DISPLAY indicates the partial "halfsteps". When the partial gets below -10 or above 10 partials, the decrement/increment is in steps of 1 partial instead of 0.5 partials*

*(Partials are multiples or divisions of a fundamental pitch. Partial no. 2 is twice the fundamental pitch and so on.)*

**DISPLAY OF 'KTB OFF HZ' FOR ALL WAVEFORMS**

When the KBT OFF HZ function is activated the LED DISPLAY switches to show the frequency in Hz. The frequency value is displayed the same way for every waveform. In Dual Sine mode the frequency value pertains to sine wave 2A, which is also the Carrier when in Dual Sine FM mode. In the picture below, the middle C (C4) note is our reference note. If you turn the COARSE knob the pitch will increment or decrement in steps of 1 semitone and the LED DISPLAY will increment or decrement and show the corresponding frequency in Hz. The range is 8.66 Hz to 12.5 kHz.

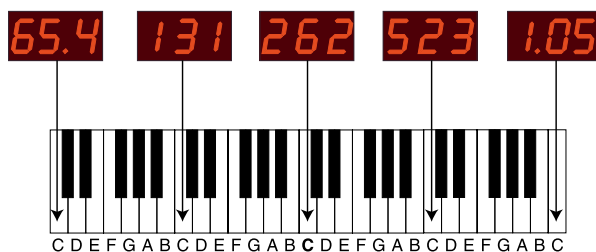

*When the frequency exceeds 1000 Hz, the LED DISPLAY switches to indicate the frequency in kHz with a dot indicating the 'k' figure.*

## OSCILLATOR MODULATION

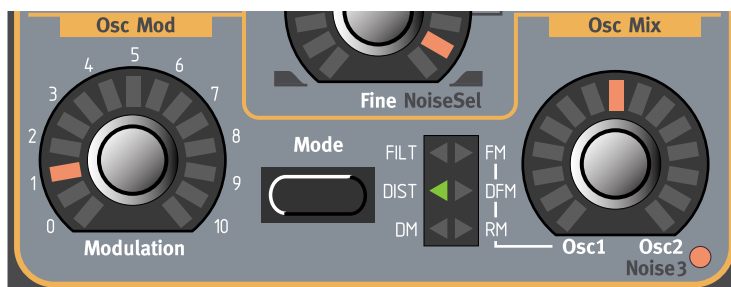

### MODULATION AMOUNT

Turn the **MODULATION AMOUNT** knob to change the amount of modulation selected with the **MODE** knob. See the paragraphs below for information of what the Modulation parameter does in the different Modes. Note that the amount of Oscillator Modulation can be controlled from the Mod Env and the two LFOs, and also manually from a Morph group.

### MODE

Press the **MODE** knob to select one of six different Oscillator Modulation types:

#### DM

DM stands for Distortion Modulation and is another special feature of Nord Lead 3. With this type of modulation you can create really unique and extremely “raw” sounds. DM is basically a combination of Amplitude/Ring Modulation and Distortion. The diagram below shows the principles of DM.

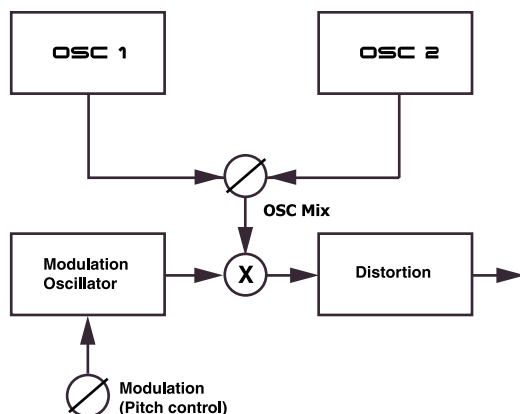

*The mixed signal from Oscillator 1 and 2 is routed to one input of a multiplier. A modulation signal, generated by a third “hidden” oscillator, is routed to the other input of the multiplier. You control the pitch of the third oscillator with the **MODULATION** knob. The amplitude modulated signal from the multiplier is then routed via a clip distortion “module”.*

In the DM configuration the **MODULATION** knob controls the *pitch* of the modulating signal and not, as in other modulation types, the amount of modulation. You change the pitch of the modulating signal in semitone steps rather than “continuously”. This makes it a lot easier to find useful modulation frequencies. The pitch of the modulating signal also fully tracks the keyboard. Be sure to check out the DM feature of Nord Lead 3. You’ll be able to create sounds unlike any you’ve ever heard before!



**DIST**

DIST stands for Distortion. In DIST mode the signal from the Oscillator Mixer is routed through an overdrive type of distortion processor. The MODULATION knob controls the amount of overdrive distortion of the mixed signal from Oscillator 1 and 2.

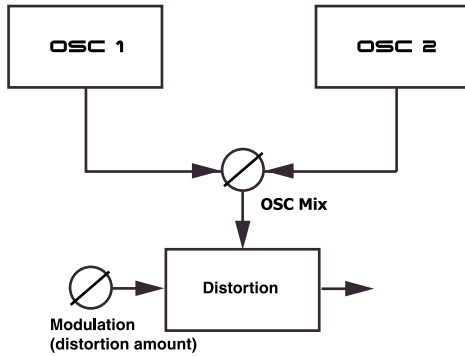

*The MODULATION knob controls the amount of overdrive distortion of the mixed signal from Oscillator 1 and 2*

**FILT**

FILT stands for Filter Frequency Modulation and is special feature of Nord Lead 3. In Filter FM mode the signal of Oscillator 2 frequency modulates the cutoff frequency parameters Frequency1 and Frequency2 in the Filter section.

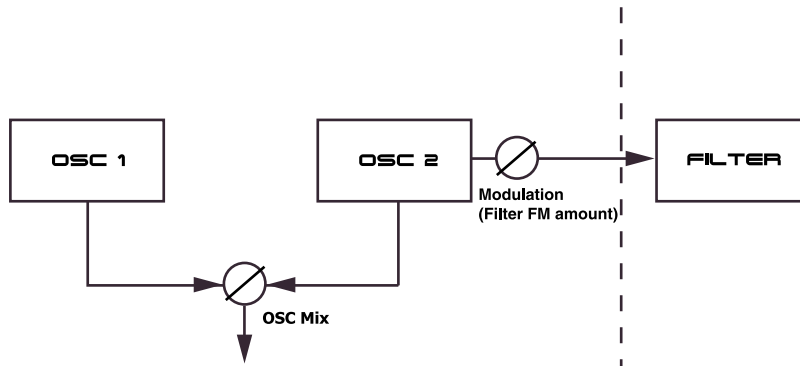

*The signal of Oscillator 2 frequency modulates the cutoff frequency parameters Frequency1 and Frequency2 in the Filter section.*

To visualize what happens, lets show an example with a single lowpass filter:

The Oscillator 2 signal modulates the Filter cutoff frequency, i.e. the Frequency1 parameter, at the rate determined by the Oscillator 2 pitch. The modulation is linear and symmetrical around the initial cutoff

frequency setting. Since you modulate from an oscillator, you're able to modulate the Filter cutoff at audio frequency.

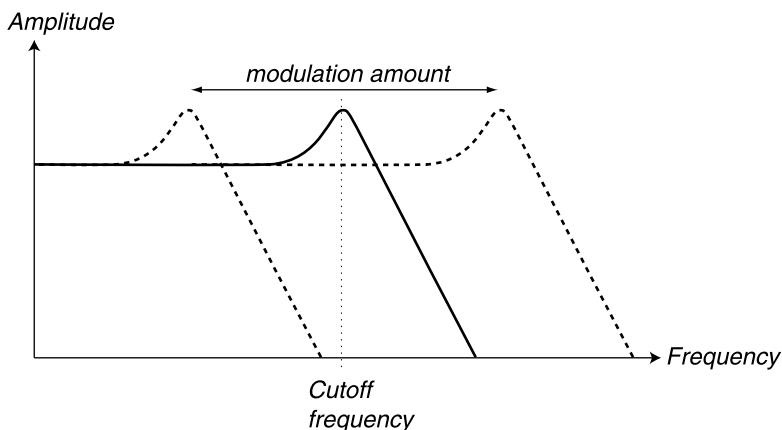

Filter FM can be used for all sorts of sounds, from weird effects to vocal like or resonant sounds. Note that since it's the cutoff frequency that is modulated, the sound is also very much affected by the Resonance setting of the Filter. To reach characteristic effects with Filter FM it's therefore recommended to use high Resonance values.

#### FM AND DFM

The Oscillator Modulation section features two types of linear Frequency Modulation: FM and DFM. An FM sound generally generates more frequency bands than a DFM sound and is often perceived as "rawer" and "brighter". DFM, Differential Frequency Modulation, is the type of Frequency Modulation used in some well-known FM synthesizers of the eighties. In FM and DFM mode, Oscillator 2 frequency modulates Oscillator 1. In FM speak, Oscillator 1 is the Carrier and Oscillator 2 is the Modulator. This means that changing the pitch of Oscillator 2 basically does not affect the pitch of the sound, but the timbre. The MODULATION knob controls the amount of FM or DFM from Oscillator 2 to Oscillator 1.

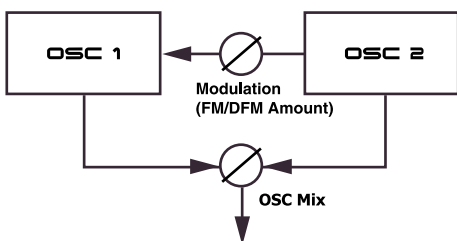

If both oscillators are in Dual Sine FM mode you can combine them into a 4 operator FM engine. With the MODULATION knob you control the FM or DFM amount from Oscillator 2 to Oscillator 1.

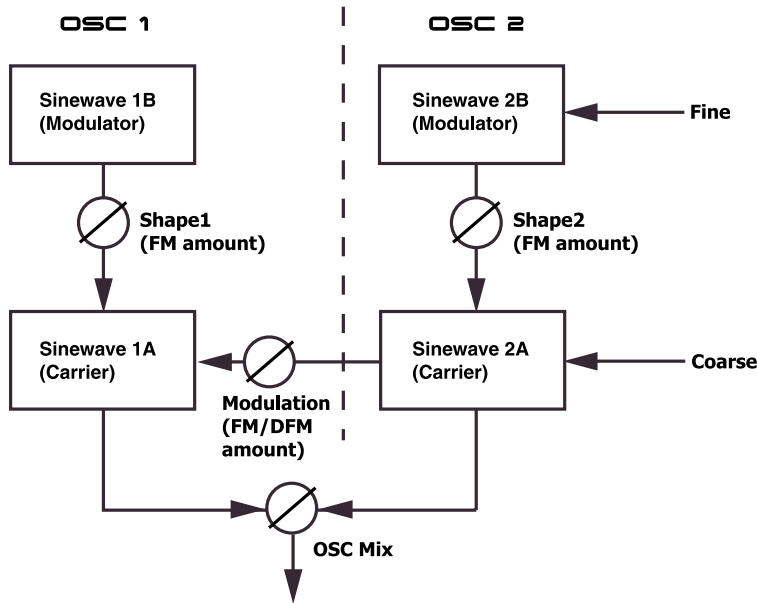

*If both oscillators are in Dual Sine FM mode and you select FM or DFM, the modulated output signal from Oscillator 2 in turn modulates Oscillator 1's sine wave 1A (Carrier). This configuration makes it possible to create complex FM sounds in a very easy way.*

The practical audible difference between a DFM and an FM signal is that the frequency spectrum of the DFM signal looks the same across the note range, but with different pitches, of course. This gives the same kind of impression as when you use the Keyboard Tracking function in the Filter on traditional "subtractive" waveforms. The spectrum of an FM signal, on the other hand, changes quite drastically across the note range.

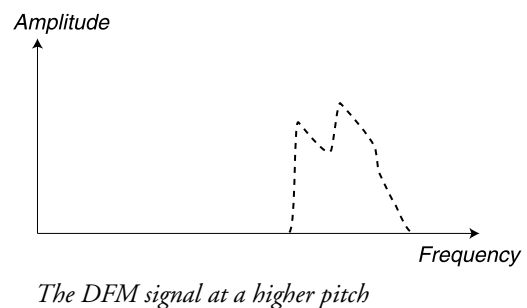
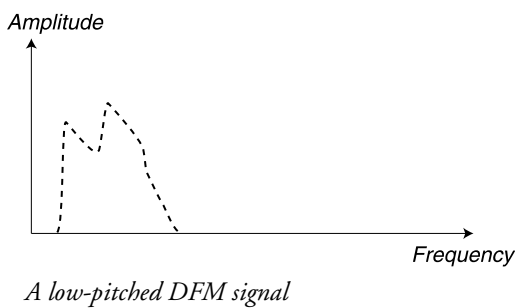
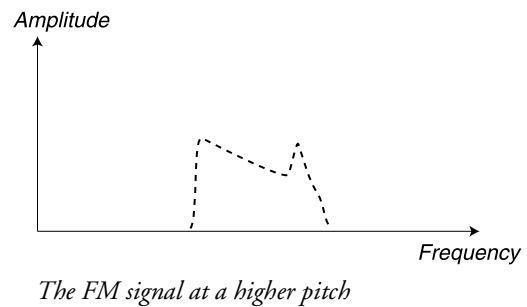
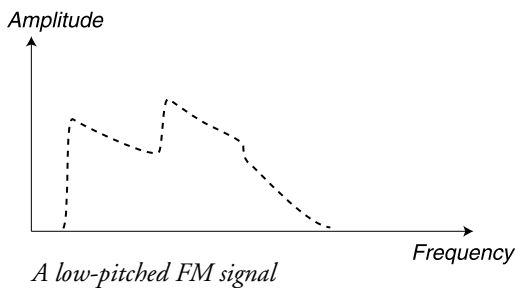

**USEFUL OSCILLATOR COMBINATIONS WITH FM AND DFM MODULATION**

If you're familiar with FM synthesizers, you may remember that some of them had a number of algorithm diagrams printed on their front panels. Each of these algorithms described how different sine wave generators were connected and interacted with each other. In a similar way it's possible to describe different Frequency Modulation combinations in Nord Lead 3:

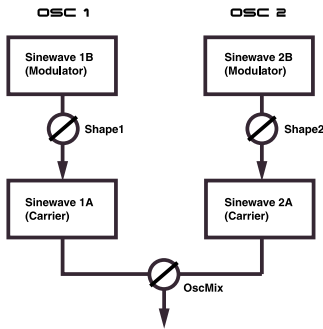

1. Both oscillators in Dual Sine FM mode with zero FM/DFM OscMod and selectable OscMix

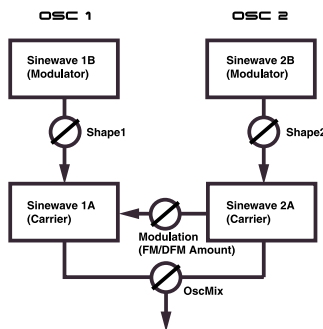

2. Both oscillators in Dual Sine FM mode with FM/DFM OscMod and selectable OscMix

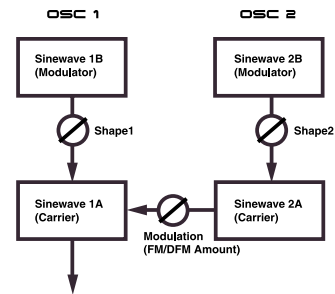

3. Both oscillators in Dual Sine FM mode with FM/DFM OscMod. OscMix set fully to Osc1

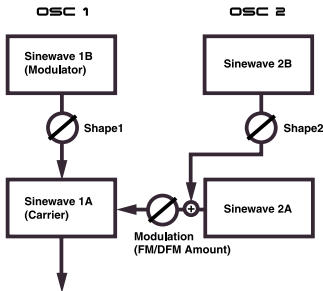

4. Oscillator 1 in Dual Sine FM mode and Oscillator 2 in Dual Sine mode with FM/DFM OscMod. OscMix set fully to Osc1

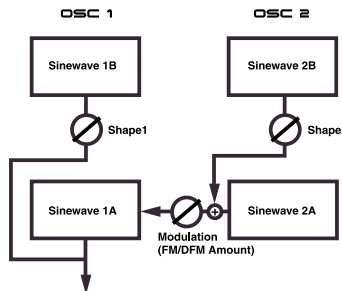

5. Oscillator 1 in Dual Sine mode and Oscillator 2 in Dual Sine FM mode with FM/DFM OscMod. OscMix set fully to Osc1

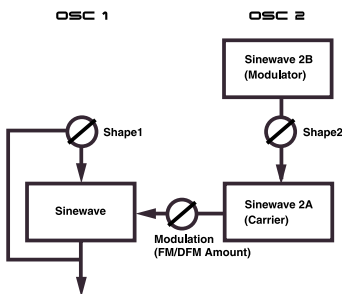

6. Oscillator 1 in Sine mode (with feedback) and Oscillator 2 in Dual Sine FM mode with FM/DFM OscMod. OscMix set fully to Osc1

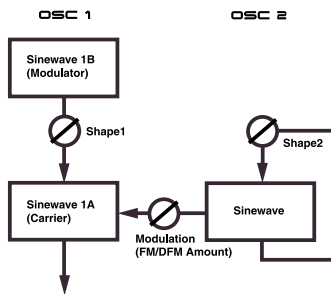

7. Oscillator 1 in Dual Sine FM mode and Oscillator 2 in Sine mode (with feedback). FM/DFM OscMod. OscMix set fully to Osc1

*Tip! When using several sine wave generators to modulate each other it is often more practical to use DFM instead of FM in the Osc Mod section. If you use FM, you will find that quite often the pitch will drift away. This is normal but in most situations not a desirable effect.*

**RM**

Ring Modulation, RM, is a function where the signals of the two oscillators are multiplied. The result is a disharmonic sound that is great for metallic or bell-like timbres. When trying out Ring Modulation, make sure you set the **OSC MIX** knob mainly to Oscillator 1, since it's the oscillator that is affected by the timbre changes. The **MODULATION** knob controls the amount of Amplitude/Ring Modulation. Between the values 0 and 5.0 you get Amplitude Modulation and between the values 5.0 and 10.0 Ring Modulation occurs.

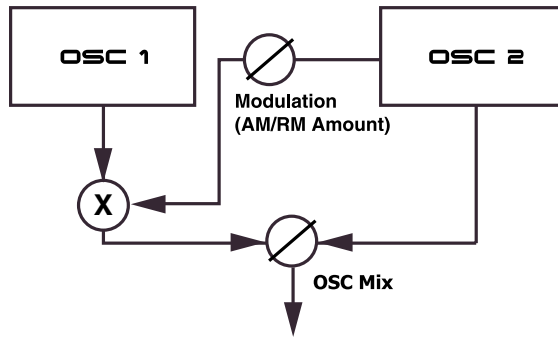

*The signal from Oscillator 2 is multiplied with the signal of Oscillator 1. The signal from Oscillator 2 is also routed directly to the Mixer. This means the more towards the OSC1 you mix the signal, the more modulated the signal.*

Below is a picture of how two simple sinewave signals are used for amplitude and ring modulation

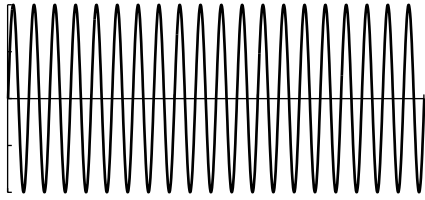

*The Oscillator 1 signal*

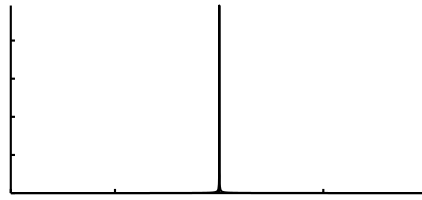

*The Oscillator 1 signal's frequency spectrum*

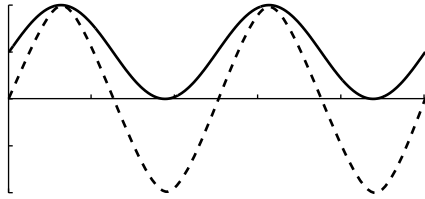

*The Oscillator 2 signal used for modulating the Oscillator 1 signal. The line shows maximum AM and the dashed line shows maximum RM*

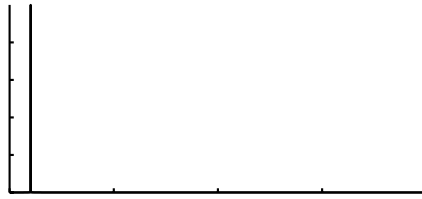

*The Oscillator 2 signal's frequency spectrum*

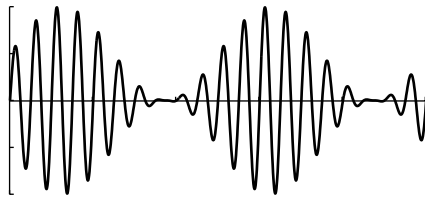

*The Oscillator 1 signal at maximum Amplitude Modulation*

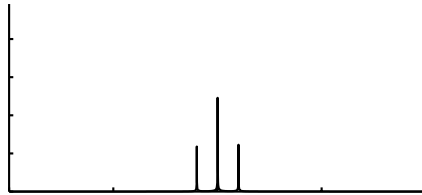

*The Oscillator 1 signal's frequency spectrum at maximum Amplitude Modulation*

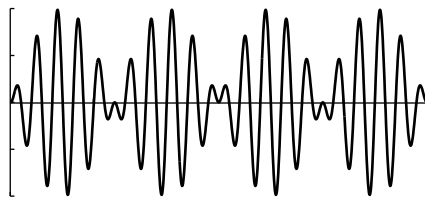

*The Oscillator 1 signal at maximum Ring Modulation*

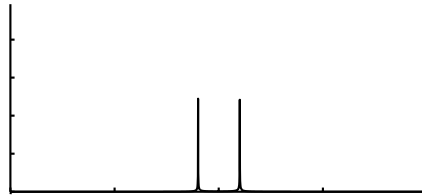

*The Oscillator 1 signal's frequency spectrum at maximum Ring Modulation*

As you can see in the figures above, the main practical difference between amplitude- and ring modulation is the sideband amplitudes and the appearance of Oscillator 1's original signal in the frequency spectrum. Another difference is that the resulting ring modulation signal phase-shifts 180 degrees every half modulator (Oscillator 2) period. The amplitude modulated signal doesn't phase-shift.

If more complex waveforms are used for amplitude- or ring modulation, sidebands will be generated for each partial of the signal.

## OSCILLATOR MIXER



### Osc Mix

Set the balance between Oscillator1 and 2 in the mix with the **OSC MIX** knob. The Osc Mix parameter also has alternative functionality depending on what Modulation Mode you have selected (see the Modulation paragraph above).

### OSCILLATOR MIXER NOISE (NOISE3)

Hold down **SHIFT** and turn the **OSC MIX** knob to replace the Oscillator 2 output signal in the mix with noise. Adjust the amount of noise with the **OSC MIX** knob. The more towards the **Osc2** value you turn the **OSC MIX** knob, the more noise you'll get in the mix. This may seem like a strange function but it's actually quite useful for adding "breath" noise in the attack phase of wind instrument simulations, for example. This feature is extremely useful in FM sounds where you mainly use the signal from the Oscillator 1 section. To get noise only in the attack phase of a sound, you could assign the Osc Mix parameter to the Modulation Envelope, for example.

Below is a diagram of how this is configured in 4-operator FM mode.

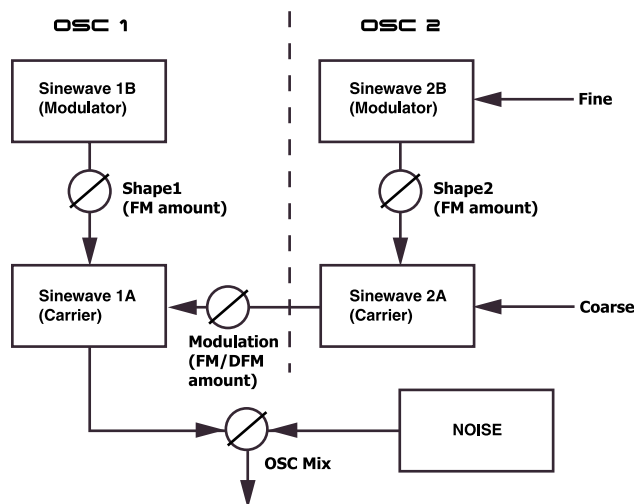

*If both oscillators are in Dual Sine FM mode and you select FM or DFM, the modulated output signal from Oscillator 2 in turn modulates the Oscillator 1's sine wave 1A (Carrier). With Noise3 selected, the Oscillator 2 output to the Mixer is replaced by a "hidden" noise oscillator. You control the amount of noise in the resulting signal with the **OSC MIX** knob.*

Note that using Noise3 doesn't disable Oscillator 2's settings or parameters at all - you only deactivate its signal output to the mixer and replace it with noise. This means that it's quite possible to have the oscillators in 4-operator FM mode and also add noise to the resulting signal, for example.

## AMPLIFIER ENVELOPE



An amplifier is most often used at the final stage of a synth signal chain, to control volume. By modulating the amplifier with an envelope, the sound can be given its basic “shape”. In fact, the “volume shape” is one of the most important factors to how we identify the sound. By setting up a proper volume envelope you can make a sound “soft”, “hard”, “plucked” “static” etc.

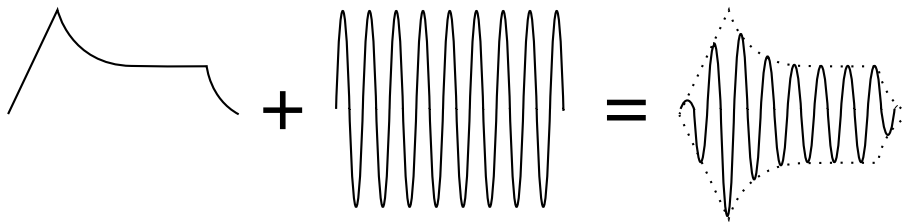

The volume envelope curve (to the left) determines how the amplitude of the waveform changes over time.

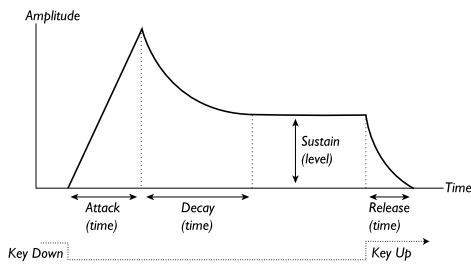



## ATTACK

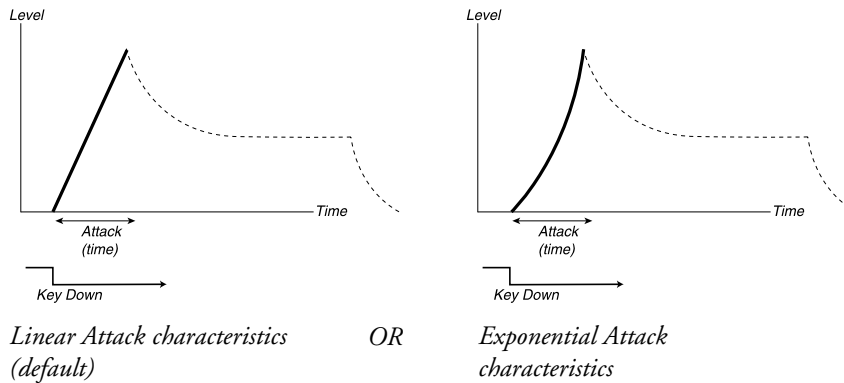

The **ATTACK** knob is used to adjust how long it should take for the sound to reach from zero to full amplitude after a key has been pressed. Hold down **SHIFT** and turn the **ATTACK** knob clockwise to select exponential attack characteristics. The LED to the bottom right of the **ATTACK** knob will light up. Hold down **SHIFT** and turn the **ATTACK** knob counter-clockwise to revert to normal attack characteristics.

**Note:** a very short attack time could produce a click in the beginning of the sound. This is a normal physical phenomenon. To eliminate any click, just increase the attack time slightly.

Range: 0.5 ms to 45 s.

## DECAY

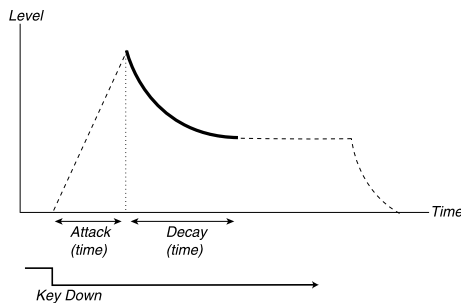

When the Attack phase is finished (and you haven't released the key), the Decay takes over. During the Decay phase, the sound decreases in level, and continues to do so until it reaches the Sustain level (see below). The **DECAY** knob is used to adjust how long this should take.

Range: 0.5 ms to 45 s.

## SUSTAIN

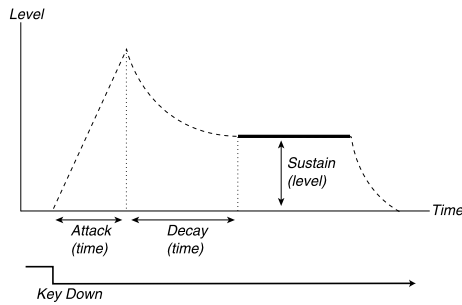

This is the level the sound will reach after the Decay phase is finished. Once this has happened, the sound will stay steady at this level until the key is released. Set the sustain level with the **SUSTAIN** knob.

Please note that the Sustain parameter is used to set a level, while Attack, Decay and Release are all used to set times.

Range: -infinity to 0.0 dB.

## RELEASE

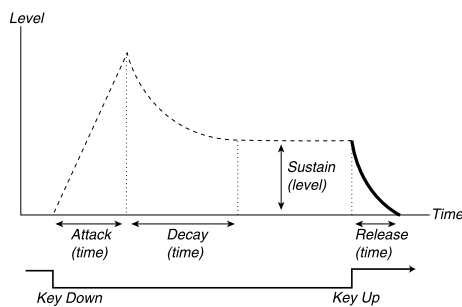

The **RELEASE** knob is used to adjust how long it should take for the sound to decay from the sustain level to silence after you have released the key.

**Note:** a very short release time could produce a click in the end of the sound. This is a normal physical phenomenon. To eliminate any click, just increase the release time slightly.

Range: 0.5 ms to infinity.

## ADSR ENVELOPE BEHAVIOR

If you set the Sustain to full level, the Decay setting is of no importance since the volume of the sound is never lowered (until you release the key).

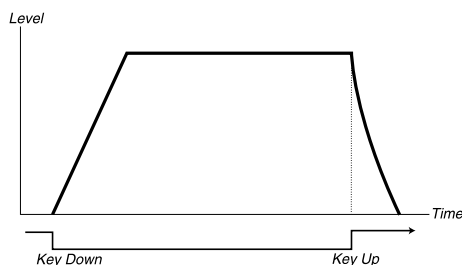

If you set the Sustain to 0, the sound will become silent after the Decay phase is finished. With short Attacks and moderate Decay times, this can be used to simulate the behaviour of a plucked string instrument (guitar, piano etc.) where the sound always decays to silence after a while.

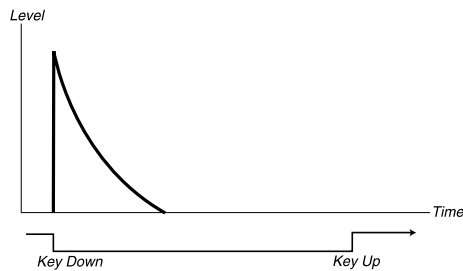

If a key is released before the envelope has completed one or more stages, the envelope will jump directly to the Release stage at the corresponding level.

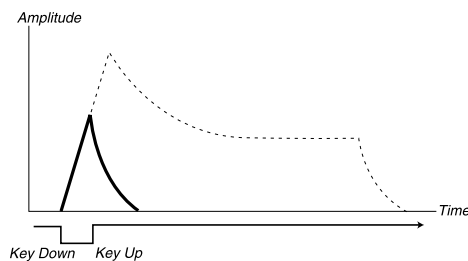

## OUTPUT LEVEL



The LEVEL knob is used to adjust the output level of individual sounds (Programs). This parameter can also be used when you want to mix the levels of several (up to 4) Programs in a multi Slot configuration. The Output LEVEL parameter sends out and responds to MIDI CC#71. The synth also responds to the regular MIDI Volume Controller - MIDI CC#7 "in the background". This makes it possible to use MIDI Volume with sequencers to do mixing without destroying any Morphs set up for the Output LEVEL parameter. However, the synth only sends MIDI CC#71 from the Output LEVEL knob.

## FILTER OVERVIEW



The Filter is one of the most important components for shaping the overall timbre of the sound. Nord Lead 3 features two multi-mode filters. You can either use only one filter (Single Filter Modes) or both (Multi Filter Modes). The Filter can be controlled from the built-in Filter Envelope generator.

## FILTER ENVELOPE



The Filter Envelope is a regular ADSR envelope. The Filter Envelope controls the cutoff frequency parameter Frequency1 and can also be set to control both Frequency1 and Frequency2.

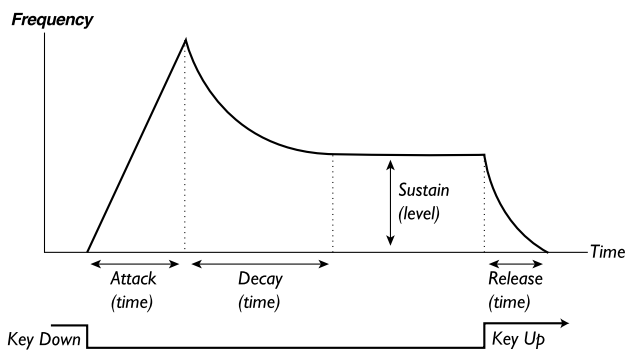

The Filter Envelope can also be used in Invert mode (see [“Invert” on page 84](#)).

## ATTACK

The **ATTACK** knob is used to adjust how long it should take for the Frequency1 (and Frequency2, if selected) parameter to reach from current value to maximum after a key has been pressed. Hold down **SHIFT** and turn the **ATTACK** knob clockwise to select exponential attack characteristics. The LED to the bottom right of the **ATTACK** knob will light up. Hold down **SHIFT** and turn the **ATTACK** knob counter-clockwise to revert to normal attack characteristics.

Range: 0.5 ms to 45 s.

## DECAY

When the attack phase is finished (and you haven't released the key), the Decay takes over. During the Decay phase, the Frequency1 (and Frequency2, if selected) value decreases, and continues to do so until it reaches the Sustain level (see below). The **DECAY** knob is used to adjust how long this should take.

Range: 0.5 ms to 45 s.

## SUSTAIN

This is the Frequency1 (and Frequency2, if selected) value the sound will reach after the Decay phase is finished. Once this has happened, the Frequency1 (and Frequency2, if selected) value will stay steady until the key is released. Set the sustain level with the **SUSTAIN** knob. Please note that the Sustain parameter is used to set a level, while Attack, Decay and Release are all used to set times.

Range: -infinity to 0.0 dB.

## RELEASE

The **RELEASE** knob is used to adjust how long it should take for the Frequency1 (and Frequency2, if selected) value to decay from the sustain level to the value set with the **FREQUENCY1** (and **FREQUENCY2**, if selected) knobs after you have released the key.

Range: 0.5 ms to infinity.

## VELOCITY, ENVAMT AND INVERT

Use the **ENVAMT** knob to determine how much the Filter Envelope should affect the Frequency1 (and Frequency2, if selected) value.

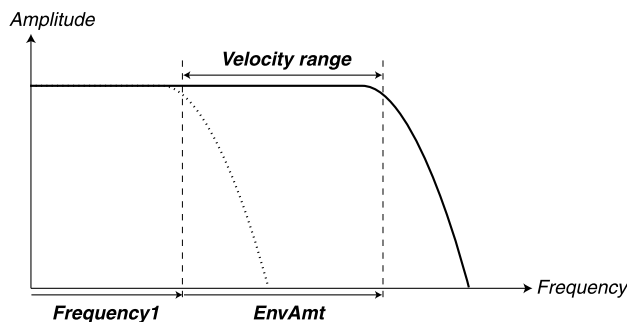

*Set the initial cutoff frequency with the **FREQUENCY1** knob. The **EnvAmt** value is added to the initial cutoff value. If you select **VELOCITY**, the **EnvAmt** value changes with Keyboard Velocity.*

The **EnvAmt** parameter operates in addition to the Filter Frequency setting(s). This means that if you for example set the **FREQUENCY1** knob half-way, the filter will already be half-open the moment you press a key. The envelope will then open the filter further. Exactly how much further is determined by the **EnvAmt** setting.

Let's take another example of the relation between Frequency and Envelope Amount: If the **FREQUENCY1** knob is already turned fully clockwise, the Envelope Amount setting has no effect at all, since the filter is already fully open the moment you press the key.

### INVERT

Hold down **SHIFT** and turn the **ENVAMT** button clockwise to invert the Filter Envelope amount. The red LED to the bottom right of the **ENVAMT** knob will light up. In Invert mode, the envelope curve flips upside-down as shown in the figure below. It's still representing only positive Frequency values but starts and ends at maximum frequency value instead of minimum value. Note that the higher the Sustain value in Invert mode, the lower the frequency value.

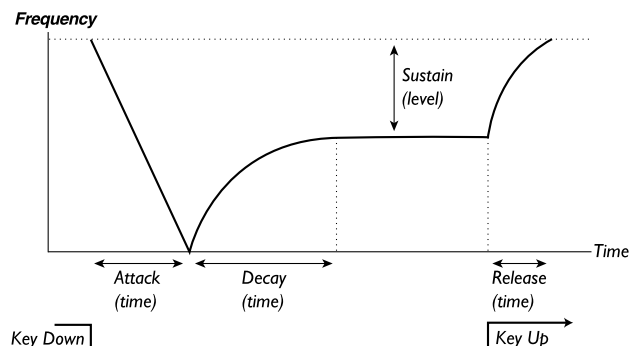

Hold down **SHIFT** and turn the **ENVAMT** knob counter-clockwise to revert to positive Filter Envelope.

## SINGLE FILTER MODES



In Single Filter Modes you use a single filter where you can control cutoff frequency, slope, filter mode, resonance and Keyboard Tracking.

## FREQUENCY 1

With the **FREQUENCY1** knob you set the cutoff frequency (or center frequency in BP and BR mode). If you for example select a lowpass (LP) filter and turn the **FREQUENCY1** knob clockwise, a more and more high-frequent signal will be output from the filter.

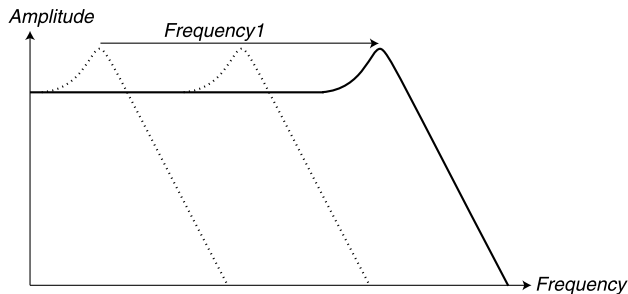

*The more you “open” a lowpass filter, the more high-frequent the output signal*

Note that if the EnvAmt value is above zero, turning the **FREQUENCY1** knob might not change the sound as expected.

## FILTER SLOPE (ROLL-OFF)

The slope of a filter determines how steep the frequency attenuation curve is. In Single Filter Modes in Nord Lead 3 you can select between 6 dB/octave (1-pole), 12 dB/octave (2-pole) and 24 dB/octave (4-pole) slopes for the LP (lowpass), HP (highpass) and BP (bandpass) filters. Press the **FILTER SLOPE** button to switch between different slopes.

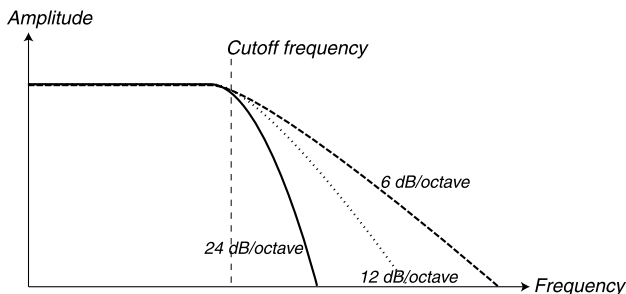

*The figure shows a LP filter with 24 dB, 12 dB and 6 dB slopes.*

### 24 DB/OCTAVE

This is the classic “synth filter” slope used in the Minimoog and Prophet-5 among others. It cuts out frequencies rather drastically, 24 dB per octave. A 24 dB filter is also known as a 4-pole filter.

### 12 DB/OCTAVE

The 12 dB/octave slope leaves more harmonics than the 24dB variation discussed above. This type of filter has been used in various early Oberheim synthesizers and others. A 12 dB filter is also known as a 2-pole filter.

### 6 DB/OCTAVE

The 6 dB/octave slope is very gentle and doesn’t cut out very much in the frequency spectrum. A 6 dB filter is also known as a 1-pole filter and is the simplest type of filter.

## RESONANCE

The Resonance parameter is used to further adjust the characteristics of the Filter. If you are using the HP, LP, CLASSIC or DIST LP filter types, increasing the Resonance will emphasize frequencies around

the set Filter Frequency (cutoff frequency), making the sound thinner. Further raising the Resonance will make the sound resonant to a point where the filter adds a ringing quality to the sound. Exactly where in the frequency spectrum this “ringing” occurs, depends on the Frequency1 value.

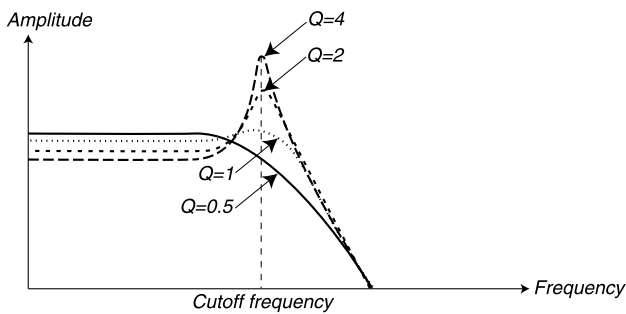

The figure shows a 24 dB lowpass filter with different resonance amounts (Q-values). Q=0.5 represents zero Resonance amount and Q=4 maximum amount.

High resonance values are also visible in the waveform. They appear as a “superimposed” waveform with a frequency equivalent to the filter’s cutoff frequency. The three examples below show the same wave with increased resonance.

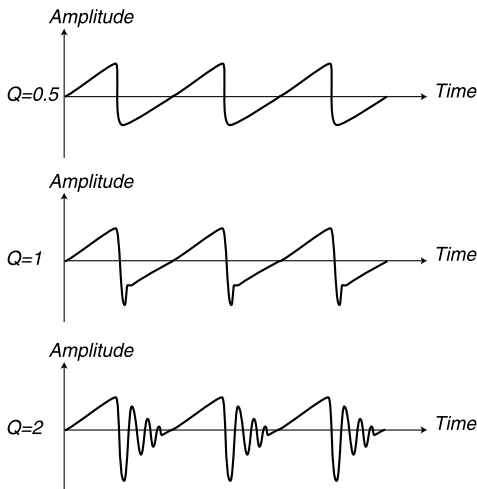

When you use the bandpass filter, adjusting the Resonance affects the width of the passband. When you raise the Resonance, the passband becomes narrower.

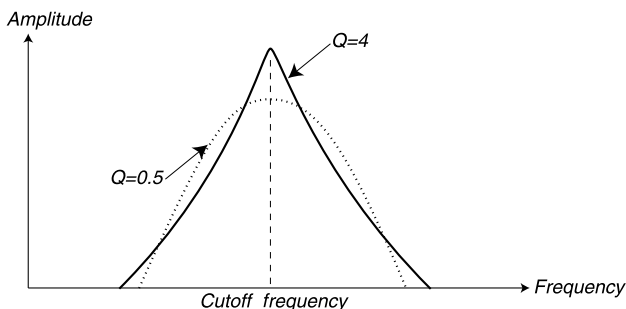

The figure shows a bandpass filter with different resonance amounts (Q-values). Q=0.5 represents zero Resonance amount and Q=4 maximum amount.



When you use the band reject (notch) filter, adjusting the Resonance affects the width of the rejected band. When you raise the Resonance, the rejected band becomes narrower.

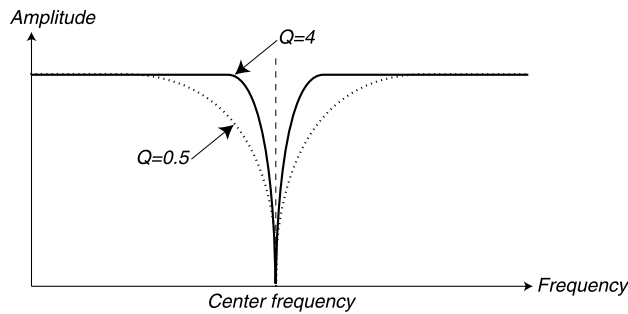

The figure shows a band reject (notch) filter with different resonance amounts (Q-values). Q=0.5 represents zero Resonance amount and Q=4 maximum amount.

**FILTER TYPE**

Press the FILTER TYPE button to switch between the different types of Single Filters.

**LP**

LP stands for lowpass. A lowpass filter lets low frequencies pass and cuts out higher frequencies. The slope in this filter can have a roll-off of 24 dB, 12 dB or 6 dB per octave according to what you select with the FILTER SLOPE button.

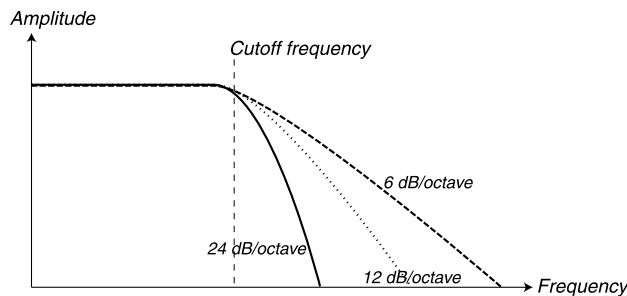

The figure shows the LP filter type with 6 dB, 12 dB and 24 dB slopes.

**HP**

HP stands for highpass. This filter is the opposite of the lowpass filter, i.e. it lets the high frequencies pass and cuts out low frequencies. The slope in this filter can have a roll-off of 24 dB, 12 dB or 6 dB per octave according to what you select with the FILTER SLOPE button.

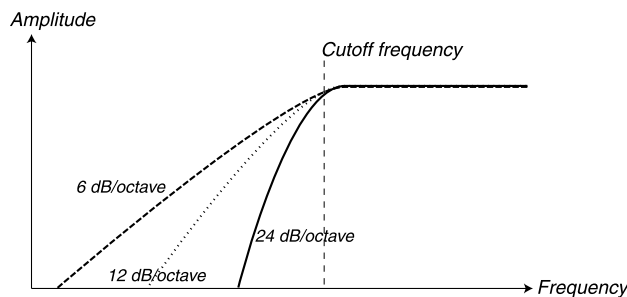

The figure shows the HP filter type with 6 dB, 12 dB and 24 dB slopes.

**BP**

BP stands for bandpass. A bandpass filter lets frequencies in a “mid-range” band pass through, while lower and higher frequencies are cut out. The two slopes in this filter can have a roll-off of 12 dB each in 24 dB mode and 6 dB each in 12 dB mode. In 6 dB mode the bandpass filter in Nord Lead 3 doesn’t actually work as a bandpass filter but rather as a parametric equalizer. This means that most frequencies in the

spectrum pass through unattenuated and that a small frequency range around the cutoff frequency can be amplified with the Resonance parameter (see below). Select roll-off with the **FILTER SLOPE** button. In bandpass filters the ‘cutoff frequency’ is also called ‘center frequency’.

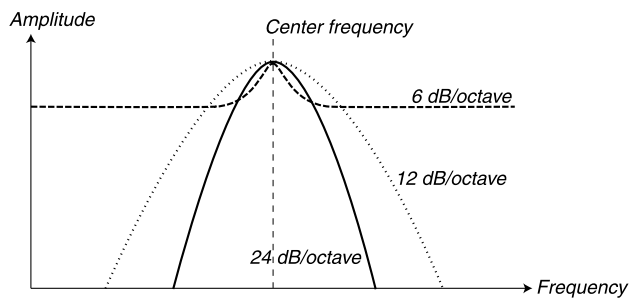

*The figure shows the BP filter type with in 6 dB, 12 dB and 24 dB modes.*

### BR

BR stands for band reject. Band reject is also known as ‘notch’. The band reject filter type can be seen as the opposite of a bandpass filter. It cuts off frequencies in a “mid-range” band, letting the frequencies below and above through. The band reject filter in Nord Lead 3 has its slopes “fixed” at 12 dB/octave each. In band reject filters the ‘cutoff frequency’ is also called ‘center frequency’.

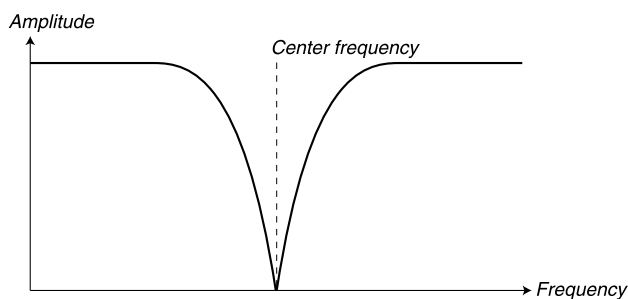

*The figure shows the BR filter type with 12 dB slopes.*

### CLASSIC

The Classic lowpass filter type is a special feature of Nord Lead 3. It’s based on a lowpass filter with a 24 dB/octave slope but has several unique characteristics. First of all, the roll-off isn’t linear but varies between 12 and 24 dB/octave along the slope. Secondly, the resonance peak (see figure below) is only half the frequency range compared to an ordinary 24 dB filter. This gives a “thinner” resonance sound when the cutoff frequency is swept. The characteristics of the Classic filter type is very similar to the classic Minimoog lowpass filter.

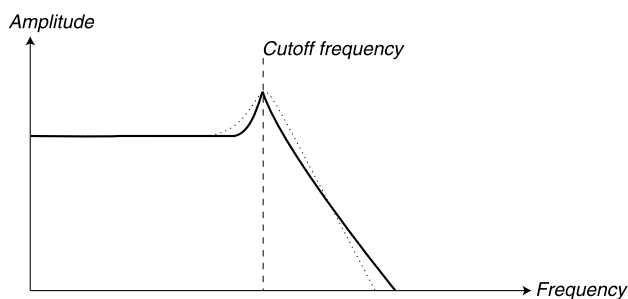

*The figure shows the CLASSIC filter with a resonance peak. The dashed line shows an ordinary 24 dB lowpass filter with its resonance peak.*

**DIST LP**

The DIST LP filter type is also a special feature of Nord Lead 3. It's based on a lowpass filter with a 12 dB/octave slope. The DIST LP filter has adjustable feedback which adds an overdrive type of distortion to the signal. You set the amount of distortion with the **FREQ2/DIST** knob.

**Note:** it's not possible to modulate the distortion amount from the LFOs or the Modulation Envelope set to **FILTER 2** destination. The distortion amount is totally separate from the regular functionality of the **Freq2/Dist** parameter.

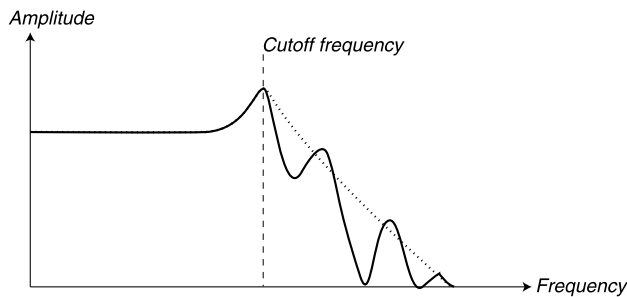

*The figure shows the DIST LP filter at full distortion. The dashed line shows the same filter without distortion.*

**KB TRACK**

With KB Track turned off (the LED is off), the Filter Frequency setting is constant regardless of where on the keyboard you play. When Keyboard Track is activated, the filter frequency setting will be higher for higher notes as indicated in the illustration below. At full Keyboard Tracking the cutoff frequency changes in the relationship 1:1 according to where on the keyboard you play. The basic note, i.e. the note that has the cutoff frequency value set with the **FREQUENCY1** knob, is C2.

The reason for using the Keyboard Track switch is related to basic acoustics. If you raise the pitch of a waveform, the harmonics naturally raise in frequency. If the cutoff frequency is constant, the sound will be perceived as getting “muddier” the higher up the keyboard you play. To avoid this effect, use KBD Track.

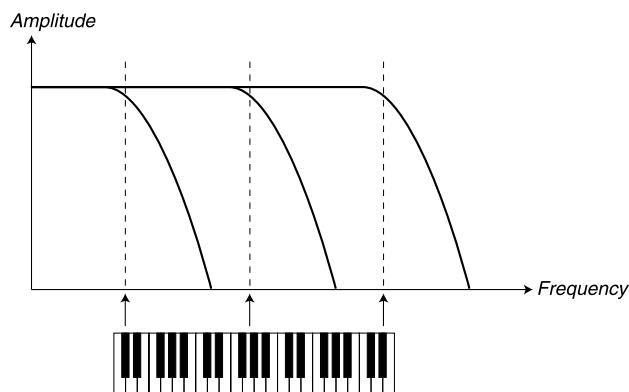

*The figure shows how the Frequency1 value changes according to where on the keyboard you play when **KB TRACK** is activated.*

**KEYBOARD TRACKING BY USING KEYBOARD MORPH**

The fact that you can only choose between full or no Keyboard Tracking by pressing the **KB TRACK** button doesn't mean you can't use other scalings. If you want to tailor-make your own Keyboard Tracking you can use Keyboard Morph. When you assign Frequency1 to Keyboard Morph, the **DISPLAY** also shows the actual keyboard tracking in %. Just make sure you deselect the **KB TRACK** function in the filter section to make this work as intended. For details on how to assign parameters to Keyboard Morph, see [Chapter "5. Morph groups" on page 29](#).

## MULTI FILTER MODES



In Multi Filter Modes several filters are combined to form more complex filter types. In these modes you use all parameters, also those in Single Filter Modes, to shape the sound.

### FREQ2/DIST

With the FREQ2/DIST knob you set a second cutoff frequency in the different Multi Filter types described below.

When editing the Frequency1 or Frequency2 parameters in Multi Filter Modes, a '\*' or '/' sign and a number is shown next to the parameter name in the DISPLAY. This indicates the relationship between the Frequency1 and Frequency2 settings. This information can be useful if you want to have a specific relationship between the cutoff frequencies.

The formula is: Frequency1 \* x.xx = Frequency2



If you turn the FREQUENCY1 knob, the Display will show the Frequency1 value and the relationship to Frequency2. In this example Frequency1 is 1/6.349 of Frequency2.

Flt1 Freq /6.349  
987.8Hz

If you turn the FREQ2/DIST knob, the Display will show the Frequency2 value and the relationship to Frequency1. In this example Frequency2 is 6.349 times Frequency1.

Flt2 Freq \*6.349  
6.27kHz

**MULTI FILTER TYPE**

When you press **MULTI FILTER TYPE** button to select a Multi Filter type, the Single Filter type selection is deactivated. The Multi Filter types uses also the Single Filter types to form the filter combination, but you won't be able to select the filter components and slopes separately.

**LP-BP IN PARALLEL (1)**

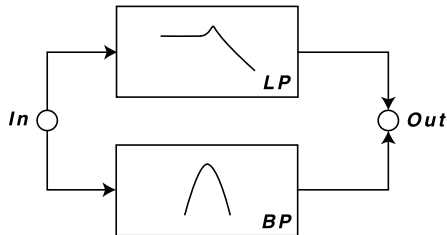

The first Multi Filter type is a combination of a 12 dB lowpass filter and a 12 (6+6) dB bandpass filter in parallel connection. Set the lowpass filter cutoff frequency with the **FREQUENCY1** knob and the bandpass filter cutoff (center) frequency with the **FREQ2/DIST** knob. Set the resonance for both peaks with the **RESONANCE** knob...

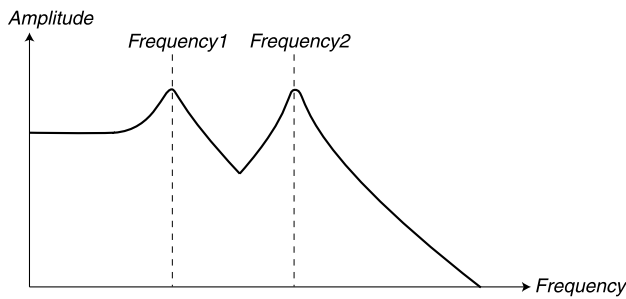

*The LP-BP parallel filter type*

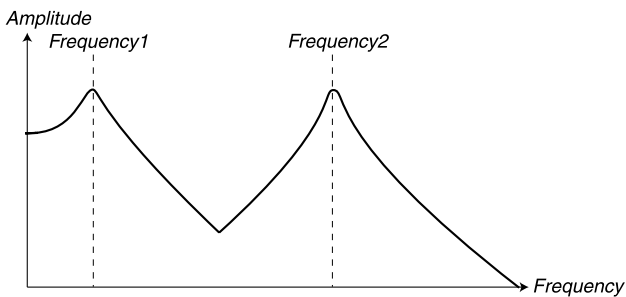

*The LP-BP parallel filter type with a greater distance between the two cutoff frequencies.*

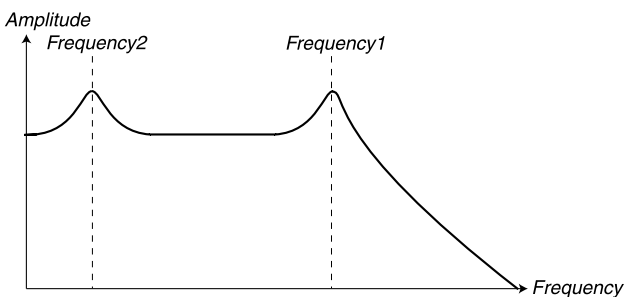

*The LP-BP parallel filter type with the two cutoff frequencies in reversed order.*

**LP-HP IN PARALLEL (2)**

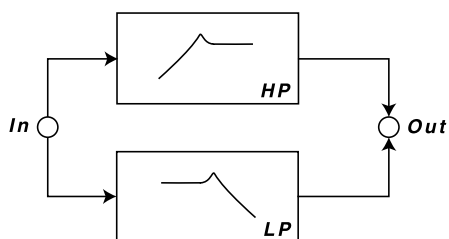

The second Multi Filter type is also a combination of a 12 dB highpass filter and a 12 dB lowpass filter but in parallel connection. Set the lowpass filter cutoff frequency with the FREQUENCY1 knob and the highpass filter cutoff frequency with the FREQ2/DIST knob. Set the resonance for both peaks with the RESONANCE knob...

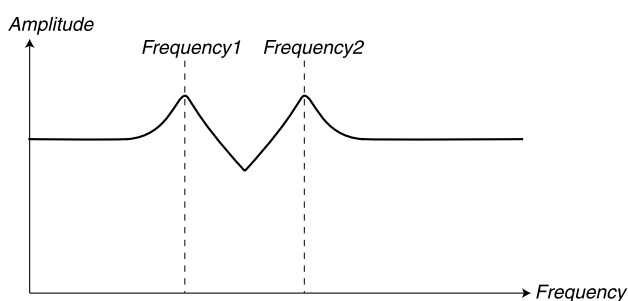

*The LP-HP parallel filter type*

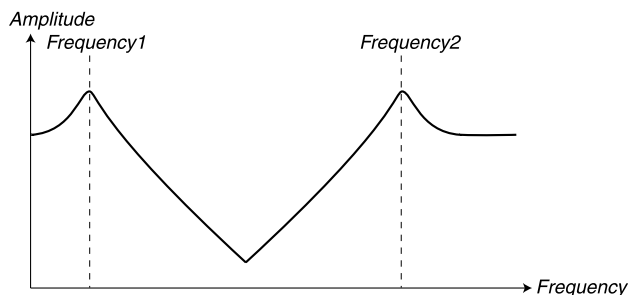

*The LP-HP parallel filter type with a greater distance between the two cutoff frequencies.*

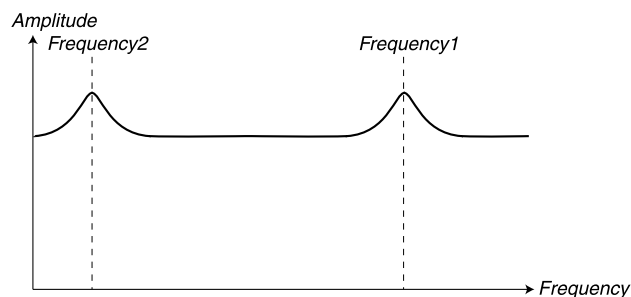

*The LP-HP parallel filter type with the two cutoff frequencies in reversed order.*

**HP-LP IN SERIES (3)**

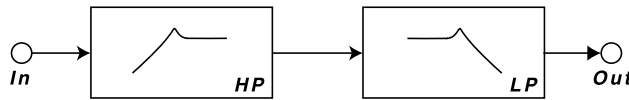

The third Multi Filter type is a combination of a 12 dB highpass filter and a 12 dB lowpass filter in series. Set the highpass filter cutoff frequency with the **FREQUENCY1** knob and the lowpass filter cutoff frequency with the **FREQ2/DIST** knob. Set the resonance for both peaks with the **RESONANCE** knob.

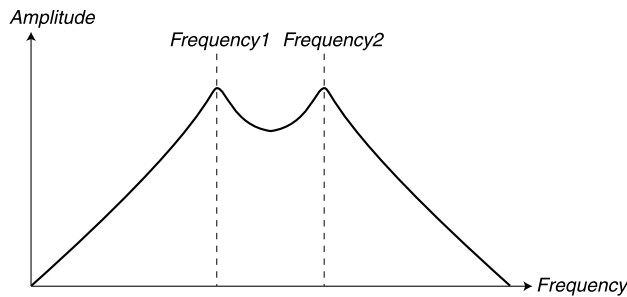

*The HP-LP serial filter type*

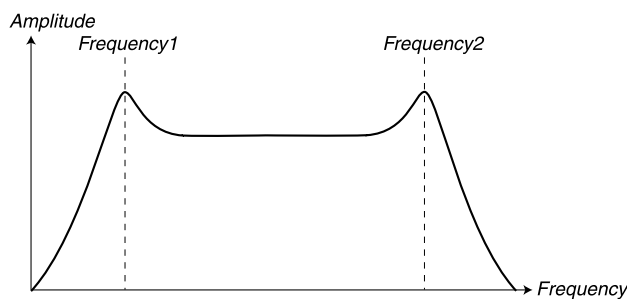

*The HP-LP serial filter type with a greater distance between the two cutoff frequencies.*

**Note:** If you set the Frequency1 value higher than the Frequency2 value, the signal will be attenuated towards silence since only the rejected bands are added (see figure below).

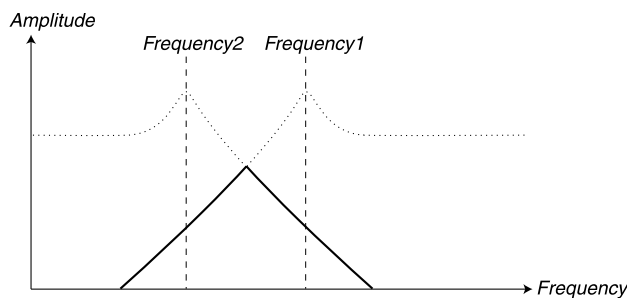

*The HP-LP serial filter type with the two cutoff frequencies in reversed order. The filled line indicates the resulting attenuation of the signal. The more you separate the peaks, the more attenuated the signal.*

**BP-BP IN PARALLEL (4)**

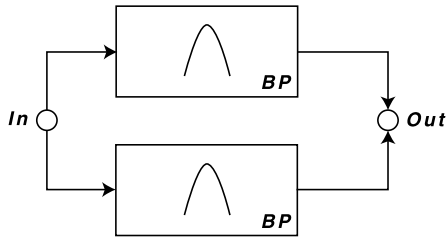

The fourth Multi Filter type is a combination of two 12 (6+6) dB bandpass filters in parallel connection. Set the center frequency of the first bandpass filter with the **FREQUENCY1** knob and center frequency of the second bandpass filter with the **FREQ2/DIST** knob. Set the resonance for both peaks with the **RESONANCE** knob.

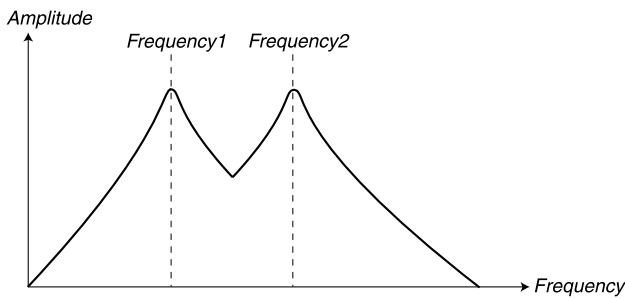

*The BP-BP parallel filter type.*

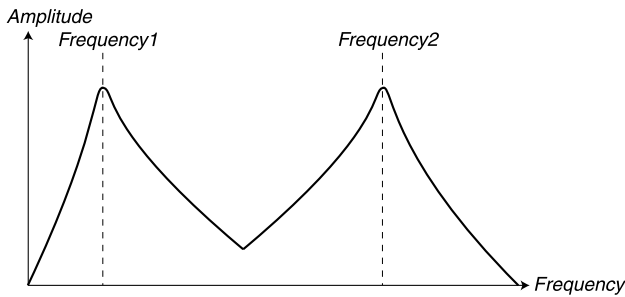

*The BP-BP parallel filter type with a greater distance between the two cutoff frequencies.*

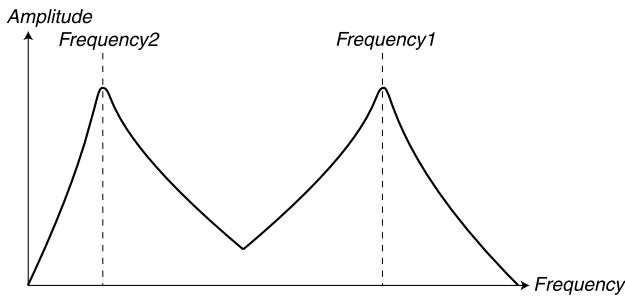

*The BP-BP parallel filter type with the two center frequencies in reversed order. As you can see, the result is exactly the same as not having them in reversed order.*



**MULTI PEAK (5)**

The Multi Peak filter type is an allpass filter with feedback. It features three allpass filters which displace the phase of the signal 180 degrees each. The Multi Peak filter type can be used for phaser effects and also for formant-type of effects. Set the center frequency with the **FREQUENCY1** knob and the peak spread, i.e. the distance between the resonance peaks, with the **FREQ2/DIST** knob. Set the resonance (feedback) for all three peaks with the **RESONANCE** knob.

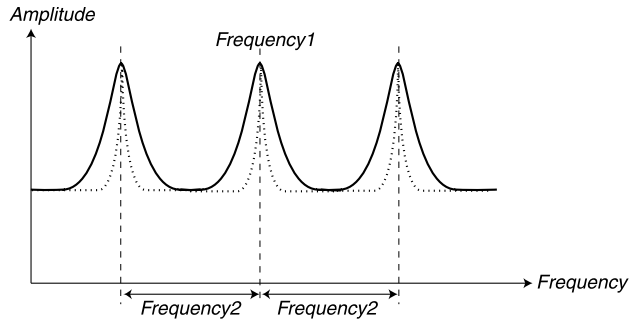

*The Multi Peak filter type. When you raise the resonance, the peaks get more narrow (the dotted line).*

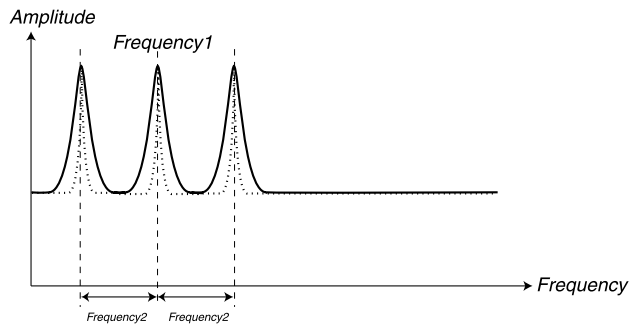

*The Multi Peak filter with a more narrow peak spread and a lower center frequency value*

**MULTI NOTCH (6)**

The Multi Notch filter type is an allpass filter with feed-forward and feedback. It features three allpass filters which displace the phase of the signal 180 degrees each. When you raise the resonance you get deeper notches and also a number of small peaks inbetween the notches. The Multi Notch filter type can be used for phaser effects and also for formant-type of effects. Set the center frequency with the **FREQUENCY1** knob and the notch spread, i.e. the distance between the notches, with the **FREQ2/DIST** knob. Set the resonance (feed-forward and feedback) for all three notches with the **RESONANCE** knob.

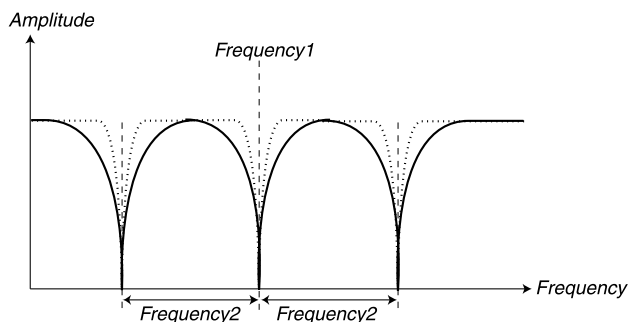

*The Multi Notch filter type. When you raise the resonance, the notches get more narrow (the dotted line).*

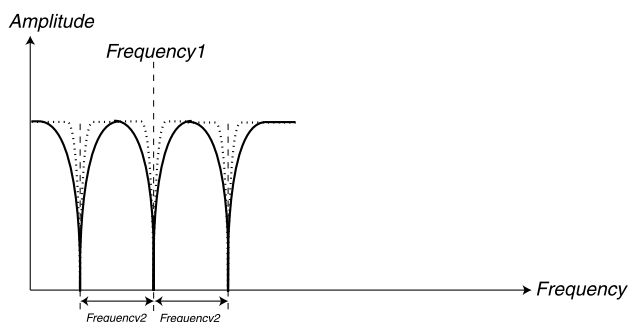

*The Multi Notch filter with a more narrow peak spread and a lower center frequency value*

**OSC2BYP/NOISE3 ONLY**

The Osc 2 Bypass function lets you bypass the signals of Oscillator 2 from the Filter section. This makes it possible to have a non-filtered FM sound in Oscillator 2 and a filtered subtractive sound in Oscillator 1 at the same time. However, if Noise3 is selected in the OscMix section then this noise is routed alone through the filter and both Oscillators are bypassed. Hold down **SHIFT** and press the **KB TRACK** button to bypass the signal from the Filter section. The LED below the **KB TRACK** button is lit when the Bypass function is activated.

**Note:** If you're using Noise3 in the Oscillator Mix section described on [page 77](#), this will be processed through the Filter even if you use the Osc Bypass function. This makes it possible to filter only Noise3 but bypass, for example, an FM signal. This feature opens up for FM sounds with very realistic "breath" attacks.

**FILT.ENV**

Hold down **SHIFT** and press the **MULTI FILTER TYPE** button to assign also the Frequency2 parameter to the Filter Envelope. The LED below the **MULTI FILTER TYPE** button is lit when you've made the assignment.

## THE LEFT (TOP) PANEL SECTION



### ARPEGGIO



Nord Lead 3 features a very interesting Arpeggiator. The concept is quite basic, but offers plenty of interesting possibilities. The Arpeggiator can be used with the standard Up, Down, Up/Down and Random patterns with different ranges and you can also use the Sub Arpeggiator and the Mask function to create very interesting pattern variations. You can sync the Arpeggiator to either the internal Master Clock of Nord Lead 3, to external MIDI Clock or have it “free-running” at selectable rate. You can also use the Arpeggiator together with other functions like the LFOs, Chord Memory (see below), Glide (see below) etc. for really interesting combination effects. The Arpeggiator also uses MIDI Song Position Pointer when synced to an external MIDI Clock, which means that if you record an arpeggio in an external sequencer, it will always play back the pattern exactly the same way it was recorded - even if you start the sequencer in the middle of the sequence.

#### **RATE**

Adjust the rate of the arpeggio with the RATE knob.  
Range: 30-240 BPM

**RUN**

Press the **RUN** button to activate the Arpeggiator. Now, when you press a key or several keys on the keyboard, the arpeggio starts.

**SUB ARPEGGIO**

As you know, an arpeggiator is used to repeatedly play single notes in a held chord. Since the basic arpeggiator patterns (up, down, up&down and random) are quite limited we decided to expand the functionality. In most other synths there are a number of special preset patterns to choose between, but also this solution is quite limiting. To make the patterns more dynamic and interesting we added a second arpeggiator, the Sub Arpeggio. The Sub Arpeggio in Nord Lead 3 is an additional arpeggiator that works in conjunction with the (main) Arpeggio. For each step in the Arpeggio, the Sub Arpeggio executes its own series of steps. Directions and ranges can be set separately for both arpeggios. Let's have a look at the following basic example:

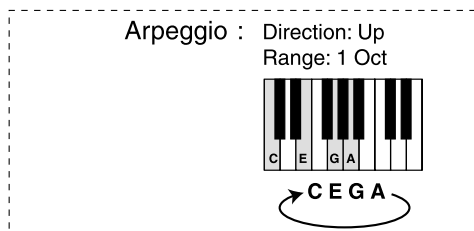

*This is the behavior when you play a C-E-G-A chord and only use the (main) Arpeggio with the direction set to 'Up' and the Range set to '1 Octave'.*

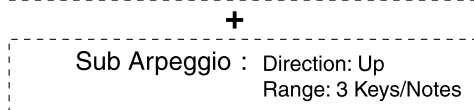

*Activate the Sub Arpeggio and set the direction to 'Up' and the Range to 3 Keys/Notes.*

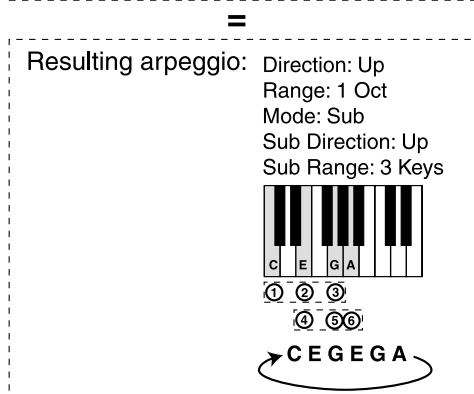

*The resulting arpeggio when combining the Arpeggio and the Sub Arpeggio and playing the C-E-G-A chord:*

1. The Sub Arpeggio begins its own pattern on the lowest note of the played chord and finishes its 3-key cycle.
2. The Sub Arpeggio restarts its pattern on the second note of the played chord.
3. When the Sub Arpeggio has completed the pattern that includes the last note in the chord the whole arpeggio restarts.

Now, let's create a similar arpeggio but with the Arpeggio Range increased to 3 octaves and see what happens:

1. Create a sound and activate the Arpeggio by pressing the Arpeggio RUN button.
2. Hold down SHIFT and press the RUN button (alternatively, press the SOUND button to the right above the DISPLAY) to enter the edit mode for the Arpeggio. The SOUND LED lights up

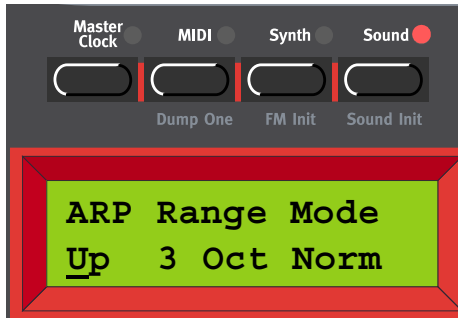

3. Select direction by turning the ROTARY DIAL. You can select between Up, Down, Up&Down and Random. Press the RIGHT NAVIGATOR button to select Range (the cursor will move to the right in the DISPLAY). Select Range (1-4 Octaves) by turning the ROTARY DIAL. Press the RIGHT NAVIGATOR button again to select Mode (Normal, Sub, Mask Sub+Mask). Turn the ROTARY DIAL to select Sub. This enables the Sub Arpeggio which we will use in this example.

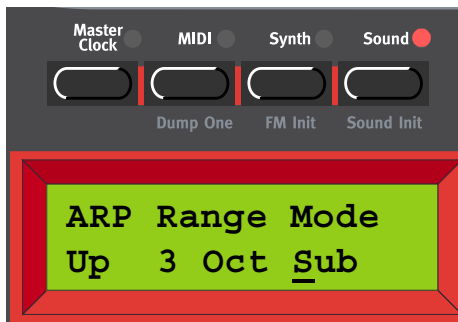

4. Press the DOWN NAVIGATOR button to enter the Sub Arpeggio menu. Here you can select between Up, Down, Up&Down, Random and Still. Press the RIGHT NAVIGATOR button to select Range (the cursor will move to the right in the DISPLAY). Select Range (1-8 keys/notes) by turning the ROTARY DIAL.



Now, let's see how the arpeggio behaves according to the settings we made above. Let's play a 4 finger chord with the notes C, E, G and A (the black dots on the keyboard below). The Arpeggio Range is set to '3 Octaves' which means the notes will be duplicated also in the following two octaves (indicated by the gray dots below) and the direction is set to 'Up'. The Sub Arpeggio has a Range of 3 keys/notes (indicated by the dashed line boxes below) and the direction is set to 'Up'.

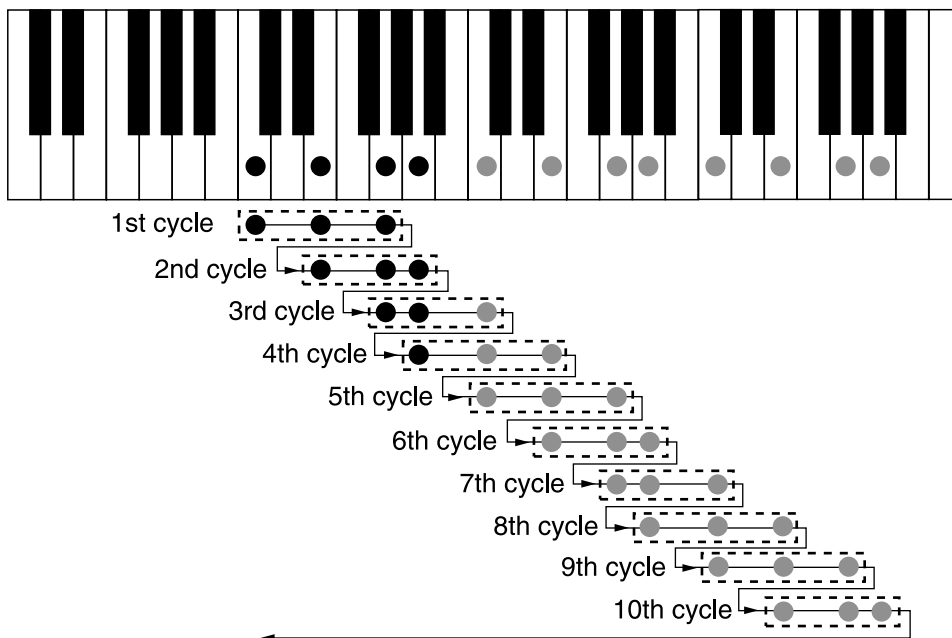

Once the arpeggio has completed the sub arpeggio pattern that includes the last note in the total range it starts all over again from the beginning. The principle for the arpeggio behavior is the same regardless of selected directions etc. If you select 'Still' in the ARP SubMode menu it means you will get repetitions of each note in the Arpeggio. The Range setting in the ARP SubMode menu determines the number of repetitions in this case.

#### **ARPEGGIO MASK**

To create even more variations to arpeggio patterns there is the Arpeggio Mask function. With the Arpeggio Mask function you are able to mute (skip) certain steps of the arpeggio, creating very interesting rhythmic effects. Here's an example:

1. Create a sound and activate the Arpeggio by pressing the Arpeggio **RUN** button

- Hold down **SHIFT** and press the **RUN** button (alternatively, press the **SOUND** button to the right above the **DISPLAY**) to enter the edit mode for the Arpeggio. The **SOUND LED** lights up

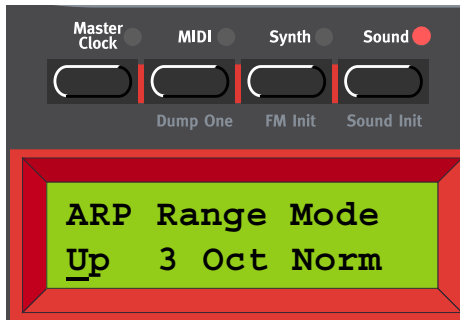

- Select 'Up' by turning the **ROTARY DIAL**. Press the **RIGHT NAVIGATOR** button to select Range (the cursor will move to the right in the **DISPLAY**). Select 3 Octaves by turning the **ROTARY DIAL**. Press the **RIGHT NAVIGATOR** button again to select Mode. Turn the **ROTARY DIAL** to select 'Mask'.



- Press the **DOWN NAVIGATOR** button twice to get to the ARP Mask menu. Here you can set the length of the Mask and enable/disable (mute/skip) steps.



- Press the **LEFT/RIGHT NAVIGATOR** buttons until the cursor is below the L. Turn the **ROTARY DIAL** counter clockwise to reduce the length to 14 steps. Press the **RIGHT NAVIGATOR** button to begin editing the steps. Move between the steps with the **RIGHT/LEFT NAVIGATOR** buttons and disable/

enable each step by turning the **ROTARY DIAL**. A filled dot means that the step is enabled and a circle means that the step should be skipped (muted).



Now, let's see how the arpeggio behaves according to the settings we made above. Let's play a 4 finger chord with the notes C, E, G and A (the black dots on the keyboard below). The Arpeggio Range is set to '3 Octaves' which means the notes will be duplicated also in the following two octaves (indicated by the gray dots below) and the direction is set to 'Up'. In this example we don't use the Sub Arpeggio, but the principle is the same also when this is used. The filled dots in the figure indicates the notes that are played and the circles indicates notes that will be muted according to the ARP Mask settings:

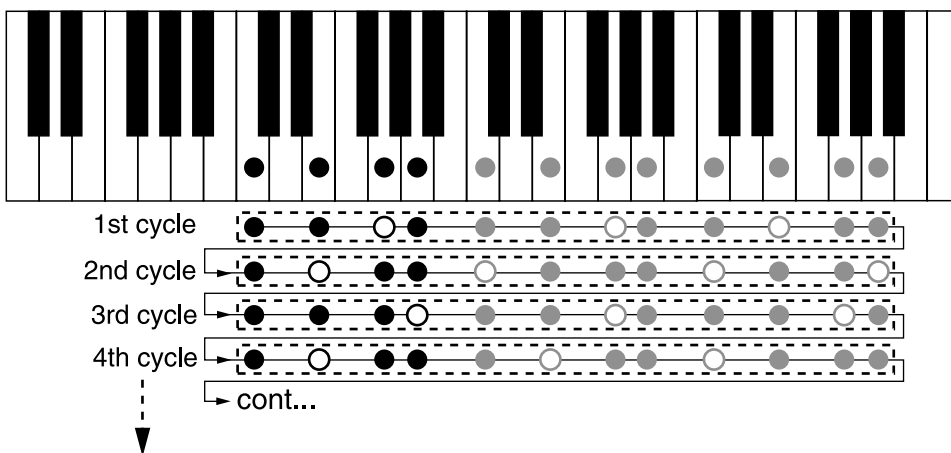

**CLOCK**

Hold down **SHIFT** and turn the **RATE** knob clockwise to sync the Arpeggiator to either the internal Master Clock of Nord Lead 3 or to external MIDI Clock. The LED below the **RATE** knob lights up to indicate Clock sync. (Hold down **SHIFT** and turn the **RATE** knob counter-clockwise to deactivate Clock sync.)





To set the parameters for internal/external sync and the internal Master Clock, press the **MASTER CLOCK** button to the left above the **DISPLAY**.



OR



In the first menu you select between Internal and External Clock sync. Select by turning the **ROTARY DIAL**. Press the **RIGHT NAVIGATOR** button and set the tempo (in BPM) with the **ROTARY DIAL**. Press the **MASTER CLOCK** button to exit.

**Note:** If you have selected External sync, the Master Clock is synced to incoming MIDI Clock signal. If no MIDI Clock signal is received, the Arpeggiator will automatically sync to the internal Master Clock. If you have selected Internal sync, the Arpeggiator will ignore any incoming MIDI Clock signal and always sync to the internal Master Clock.

**Note:** When synched to external MIDI Clock, the Arpeggiator also uses MIDI Song Position Pointer. This means that if you record an arpeggio in an external sequencer, it will play back the pattern exactly the same way it was recorded - even if you start the sequencer in the middle of the sequence.

You can also choose to sync the Master Clock to key presses. This is very useful if you are controlling both the Arpeggiator and the LFOs from the Master Clock. Press the **DOWN NAVIGATOR** button.



Select Clock Key Sync (On/Off) by turning the **ROTARY DIAL**. When Clock Key Sync is On it means that as soon as you press new key(s) after having released the previous one(s), the Master Clock restarts immediately. When Clock Key Sync is Off it means that as soon as you press a new key the arpeggio will continue at the next Master Clock signal. Press the **MASTER CLOCK** button to exit.

When you sync the Arpeggiator to the internal Master Clock or to external MIDI Clock, you can set different periods (clock divisions or multiples) to which to sync the Arpeggiator. As soon as you turn the **RATE** knob in Clock sync mode, the **DISPLAY** shows the current period:

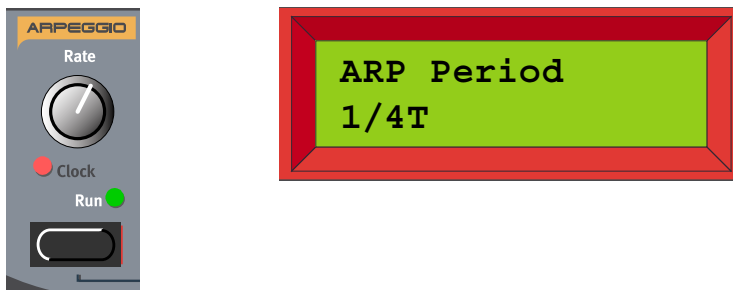

Turn the **RATE** knob, in Clock sync mode, to set the division/multiple period.  
Periods: 1/1, 1/2, 1/2T, 1/4, 1/4T, 1/8, 1/8T, 1/16, 1/16T and 1/32

#### **ARPEGGIO HOLD**

Normally, the arpeggio will continue for as long as you keep any keys pressed. By activating the KB Hold function, you can release the keys and have the arpeggio continuously playing. There is no separate Hold function only for the Arpeggio, but you use the KB Hold function in the section to the left of the **PITCH STICK** (to the right of the Arpeggio **RUN** button on Nord Rack 3).

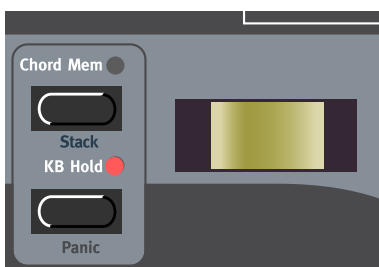

Activate Hold by pressing the **KB HOLD** button. The LED above the **KB HOLD** button lights up to indicate that Hold is activated.

The arpeggio will continue playing until you press the **KB HOLD** button again. If you turn off the Arpeggiator while Hold is active, the previously arpeggiated notes will continue to sound as if you were playing a regular chord.

## VIBRATO



Using the Vibrato function is an easy way to add vibrato to your sound without needing to route an LFO to the Oscillator(s) pitch. The Vibrato is global for the Slot, i.e. it affects all voices equally. The Vibrato can be considered a single LFO separate from the other LFOs of Nord Lead 3.

Press the **VIBRATO** button to select the source from which to control the vibrato amount. You can select between 'Wheel' (Mod Wheel), 'A.Touch' (Aftertouch) and Off. To change the Vibrato parameters (modulation amount and rate), hold down **SHIFT** and press the **VIBRATO** button (alternatively, press the **SOUND** button to the right above the **DISPLAY** and press the **DOWN NAVIGATOR** button till you reach the Vibrato parameters menu). The **SOUND LED** lights up.



Set the Vibrato amount by turning the **ROTARY DIAL**.

Range: +/- 1 semitone in steps of +/- 1 cent.

Press the **RIGHT NAVIGATOR** button once to change the Vibrato frequency. Select frequency with the **ROTARY DIAL**.

Range: 4.00-8.00 Hz.

Press the **SOUND** button to exit.

## GLIDE (PORTAMENTO)



The Glide function is mainly intended for use when playing monophonically (see below). The glide characteristics can be described as “constant rate”. “Constant rate” means that the greater the “distance” between two subsequent notes, the longer the glide time.

Turn the **RATE** knob to adjust the glide rate.

Press the **GLIDE** button to select glide mode. ‘On’ means the glide is always active and ‘Auto’ that glide is active only when you play legato (you press a new key before you release the previous key).

**Note:** If you use Glide in polyphonic mode, the glide will be unpredictable and perceived as more or less random. This is because the glide is between voices rather than between keys. The glide will therefore be from the available voices’ latest note values to the new notes rather than from the previously pressed keys. However, you can actually do parallel polyphonic Glide between keys in Legato mode which is a unique feature of Nord Lead 3. See [“Polyphonic Legato with polyphonic Glide” on page 108](#) for more info!

## VOICE MODE



The Voice Mode section consists of two parts, the Mono part and the Legato part. The two parts work totally separate from each other but it’s combinations of the two that creates interesting effects.

**MONO**

Press the **MONO** button once to select Monophonic operation. The **MONO LED** lights up. In Mono mode you can only play one note at a time, just like on a traditional monophonic synthesizer. If you play one key and then a second key without releasing the first key, the last note will sound. If you now release the last key, the first one will retrigger and start sounding again.

You can also select monophonic operation with highest or lowest note priority:

**MONO LO**

Hold down **SHIFT** and press the **MONO** button once to switch to 'Monophonic with lowest note priority'. In this mode, the lowest note has priority. Notes played above the lowest note won't sound at all. This is ideal if you for example play a layered chord and wish to play a monophonic bass line with the lowest key.

**MONO HI**

Hold down **SHIFT** and press the **MONO** button twice to switch to 'Monophonic with highest note priority'. In this mode, the highest note has priority. Notes played below the highest note won't sound at all. This is ideal if you for example play a layered chord and wish to play a monophonic melody line with the highest key.

**MONOPHONIC LEGATO**

Press the **MONO** button and the **LEGATO** button to select Monophonic Legato operation. The **MONO LED** and **LEGATO LED** light up. In Mono Legato mode you can only play one note at a time, just like on a traditional monophonic synthesizer. If you play a new key before releasing the previously played key (legato), the new note will replace the previous one at the current Envelope phase of the previously pressed key. I.e. the new note will not retrigger the Envelopes (Amplifier and Filter).

If you release the last played key before playing a new key (non-legato), the new note will sound exactly like in Mono mode, i.e. the complete Envelopes will be retriggered.

You can also use the Mono modes Mono High and Mono Low with Legato.

**POLYPHONIC LEGATO**

Press the LEGATO button to select Polyphonic Legato operation. The LEGATO LED lights up. Make sure the MONO LED(s) are off. In Poly Legato mode you can play complete chords just like in the standard polyphonic mode. If you play a new chord before releasing the previously played chord (legato), the new notes will replace the previous ones at the current Envelope phase of the first pressed key of the previous chord. I.e. the new notes will not retrigger the Envelopes (Amplifier and Filter).

Note that this is true only if the new chord has the same number of notes as the previous chord. If the number of notes in the chords differs, this is what happens:

- If the new chord has more notes than the currently played chord, the last played note(s) in the new chord will be played back normally and the other notes replace the old chord in Legato style.
- If the new chord has less notes than the currently played chord, the last played note(s) in the currently played chord will continue to sound and the other notes will be replaced by the new chord in Legato.

If you release the last played chord before playing a new chord (non-legato), the new notes will sound exactly like in normal polyphonic mode, i.e. the complete Envelopes for all notes will be retriggered.

**Tip!** The Polyphonic Legato function can also be used with the Glide function for polyphonic glide, which is a unique feature of Nord Lead 3. See below.

**POLYPHONIC LEGATO WITH POLYPHONIC GLIDE**

A special feature of Nord Lead 3 is the possibility to use Polyphonic Legato together with the Glide function for polyphonic glide! Activate the Glide function by pressing the GLIDE button (it doesn't matter if Glide is set to 'On' or 'Auto', the effect will be the same in this case when you're playing legato). Then press the LEGATO button to select Polyphonic Legato operation.

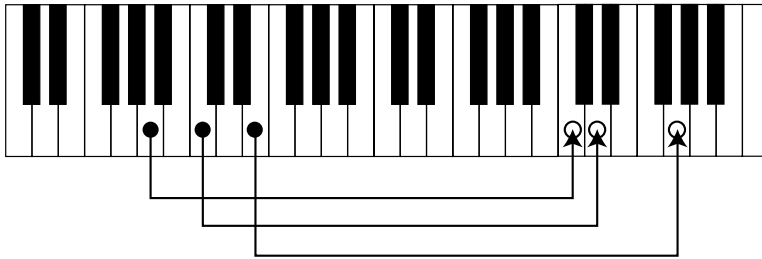

The basic behavior when using Polyphonic Legato with Glide is very similar to regular Polyphonic Legato. If you play a new chord before releasing the first played chord (legato), the old notes will glide parallel to the new notes at the set Glide rate. The new notes will replace the previous ones at the current Envelope phase of the first pressed key of the previous chord. I.e. the new notes will not retrigger the Envelopes (Amplifier and Filter). Note that this is true only if the new chord has the same number of notes as the previous chord. If the number of notes in the chords differs, this is what happens:

- If the new chord has more notes than the currently played chord, the last played note(s) in the new chord will be played back normally and the other notes replace the old chord with Legato and Glide.
- If the new chord has less notes than the currently played chord, the last played note(s) in the currently played chord will continue to sound and the other notes will be replaced by the new chord with Legato and Glide.

Tip!

When using Polyphonic Legato with Glide, it's very useful to also use the KB Hold function described on [page 114](#). This way you don't need to play legato but can release the keys after you play the chords.

If you release the last played chord before playing a new chord (non-legato), the new notes will sound like in normal polyphonic mode, with complete Envelopes, but with unpredictable Glide effect.

## UNISON



The adjustable stereo Unison function is another unique feature of Nord Lead 3. When you activate Unison, you get 5 simultaneous voices per note: 2 in the left channel, 2 in the right channel and one in the center. The Unison is always in stereo for even greater effect. This opens up for extremely rich and fat sounds. The Unison of Nord Lead 3 doesn't reduce the polyphony!

Press the UNISON button to activate the stereo Unison function. Adjust the detune amount among the voices with the DETUNE knob.

If you want to create even more extreme and fat sounds, you could stack several notes on top of each other by using the Stack function described on [page 113](#).

Note that you have to have two separate output cables connected to either Out A and B or to Out C and D to get the stereo effect, if you don't use headphones. It's also necessary to check the Audio Routing for the Slot you're using. See "[Audio Routing](#)" on [page 125](#) for more info.

## KEYBOARD SPLIT

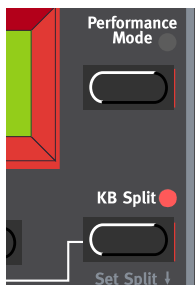

The Keyboard Split function allows you to split the keyboard in two sections, each playing separate Programs/sounds. This can be very useful when you are playing live, since it lets you use the Nord Lead 3 as if it were two independent synthesizers, with different sounds. When Keyboard Split is activated, Slots A and B will be played from the lower part of the keyboard, while Slots C and D will be played from the upper part. Activate Keyboard Split as follows:

1. Press **SLOT A** and select a Program for it. This will be the sound heard when you play the lower part of the keyboard.
2. Select **SLOT C** and select a Program for it. This will be the sound heard when you play the upper part of the keyboard.
3. Press the **SLOT A** and **SLOT C** buttons at the same time so that the LEDs above both Slot buttons light up (the LED for the last pressed Slot button will flash).
4. Press the **KEYBOARD SPLIT** button. The red LED above the button lights up to indicate that the keyboard is split.



If you now play the keyboard, you will hear the sound of Slot A from the left part of the keyboard, and the sound of Slot C from the right part of the keyboard.



- To exit the Keyboard Split mode, press the **KEYBOARD SPLIT** button again.

### SETTING THE SPLIT POINT

You set the Split Point (the key where the keyboard should be split) in the following way:

- Hold down **SHIFT** and press the **KEYBOARD SPLIT** button.

The display shows the current Split Point for as long as you keep both buttons depressed.



- While holding down both the **SHIFT** and **KEYBOARD SPLIT** buttons, press the lowest key for the upper split section of the keyboard. The display shows the key you press.
- Release the **SHIFT** and **KEYBOARD SPLIT** buttons.

### COMBINING SPLIT AND LAYER

Since Slots A and B will be played from the lower part of the split keyboard, and Slots C and D from the upper part, you can split the keyboard and play layers of two sounds on each keyboard half. Just select all Slots, and activate Keyboard Split.

## OCTAVE SHIFT

### SLOT OCTAVE SHIFT



In Slot Octave Shift mode (default), the **OCTAVE SHIFT** buttons affect the Program in the selected Slot only. Notes sent to **MIDI OUT** are not transposed. This means that in Slot Octave Shift mode, Nord Lead 3 can only send MIDI Notes over a range of 4 octaves (C2-C6). The Octave Shift setting is always saved with the rest of the parameters in a Program or Performance.

**Note:** Low/high Octave Shift settings in combination with extreme Tune settings for Oscillator 2 may produce pitches beyond the audible frequency range.

**GLOBAL OCTAVE SHIFT**

In Global Octave Shift mode the **OCTAVE SHIFT** buttons affect all Programs in the selected Slots. Notes sent to **MIDI OUT** are also transposed. This means that in Global Octave Shift mode, Nord Lead 3 can send MIDI Notes over a range of 8 octaves (C0-C8). To enter Global Octave Shift mode, press **SHIFT+LEFT OCTAVE SHIFT (GLOBAL)** buttons. The **OCTAVE SHIFT LEDS** switch to “inverted” display.

**Note:** The Global Octave Shift setting is not saved with Programs or Performances.

**Note:** Low/high Octave Shift settings in combination with extreme Tune settings for Oscillator 2 may produce pitches beyond the audible frequency range.

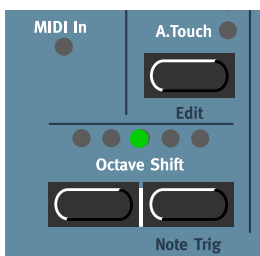
**NOTE TRIG (NORD RACK 3)**

If you shouldn't have a MIDI keyboard connected to your Nord Rack 3 it can sometimes be convenient to trig a note to audition a Program or Performance. You do this by pressing **SHIFT+RIGHT OCTAVE SHIFT (NOTE TRIG)** buttons. This will generate the note C4 for as long as you keep the buttons depressed.

**CHORD MEMORY**

The Chord Memory function makes it possible to store a chord and then play it back by only playing single keys. The chord will be transposed, equally tempered, with the key you play as the lowest note of the chord.

Play a chord with the Chord Memory function switched off. Hold the chord and press and hold the CHORD MEM button. The played keys in the chord are shown in the DISPLAY (the lowest key of the chord is displayed as '0').

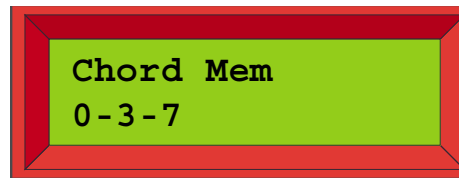
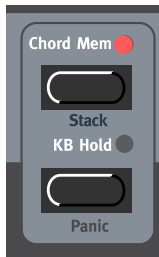

Release the CHORD MEM button and then the keys. The CHORD MEM LED stays on and the chord has been stored. Now, when playing single keys, the stored chord will be played back (and transposed). You can also (manually) play complete chords with the Chord Memory function activated. For each of the notes in the chord the stored chord will be played back and transposed.

The Chord Memory function can be saved with each Program. In Performance mode you can select different Chord Memory settings for each of the Slots and save the whole combination with the Performance.

**Note:** The chord is stored in the Chord Memory the moment you release the CHORD MEM button. This means you have to release the keys after you release the CHORD MEM button.

**Note** that since you use several notes in the Chord Memory function, the polyphony will be reduced.

**Note** that it's only the actual key(s) you play that will output MIDI Note information to the MIDI OUT - not all notes that are included in the Chord Memory!

## STACK

The Stack function is a variation of the Chord Memory function. Stack makes it possible to store a chord, and/or the same note several times (stack), and then play it back by only playing single keys. The stack/chord will be transposed, equally tempered, with the first note you stacked as the reference key of the chord.

Press and hold SHIFT and the CHORD MEM button. Play one note at a time to build up your stack/chord. Note that if you play the same note several times, they will be stacked "on top" of each other with the number of times shown within parenthesis in the DISPLAY. This makes it possible to create really fat sounds, for example. The played keys in the stack/chord are shown in the DISPLAY (the first key of the stack/chord is displayed as '0').

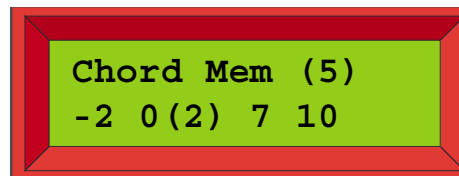
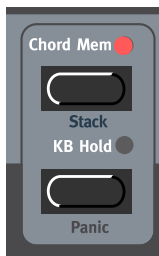

Release the **SHIFT** and **CHORD MEM** buttons. The **CHORD MEM LED** stays on and the stack/chord has been stored. Now, when playing single keys, the stored stack/chord will be played back (and transposed). You can also (manually) play complete chords with the Stack function activated.

The Stack function can be saved with each Program. In Performance mode you can select different Stack settings for each of the Slots and save the whole combination with the Performance.

**Note:** If you stack the same note several times and use the Unison function described on [page 109](#), the stacked notes will also be individually detuned for even greater effect.

**Note:** Since you use several notes in the Stack function, the polyphony will be reduced.

**Note:** It's only the actual key(s) you play that will output MIDI Note information to the MIDI OUT - not all notes that are included in the Stack!

### STACK DETUNE

As from OS V1.06 it's possible to detune stacked notes (if it's the same note) without using the Unison effect. You do this by turning the Unison **DETUNE** knob without activating the Unison effect. This means that you could stack the same note several times and then detune the cluster. Note that when using Stack Detune without the Unison function on, the detuning will not appear directly when holding a key and turning the **DETUNE** knob - you have to play new notes to hear the detune effect.

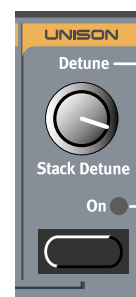
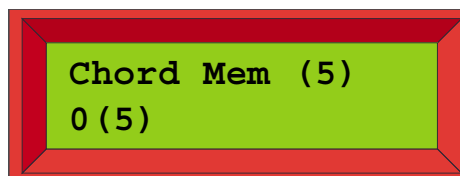
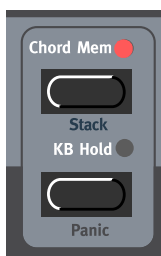

### KB HOLD

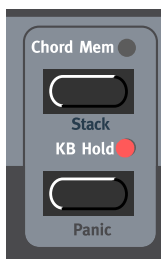

Press the **KB HOLD** button to make every note or chord you play sustain until you press any new keys. When you play a new note or chord, the previous note/chord will fade out with the Amplifier Envelope Release time and the new note/chord will sustain.

**Note:** You can choose to enable/disable the Keyboard Hold function separately for each Slot. This is especially useful when you are creating a Performance and only want some Slots to respond to Keyboard Hold. See [“Active Device”](#) on [page 116](#).

Tip!

The Hold function is perfect for use with the Arpeggiator (see “Arpeggio” on page 97) and in Polyphonic Legato mode together with Polyphonic Glide (see “Polyphonic Legato with polyphonic Glide” on page 108).

## PANIC

If notes should “hang” or the Nord Lead 3 should behave strange, all you need to do is hold down the SHIFT button and press the HOLD button. This will execute an internal All Notes Off, and reset certain parameters to their default values

## PITCH STICK (NORD LEAD 3)

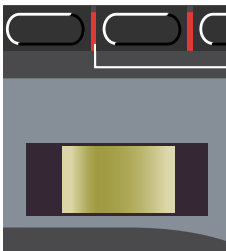

The PITCH STICK is used to bend the notes, just as with a pitch bend wheel on traditional instruments. The PITCH STICK differs from other pitch bend devices in a significant way:

- There is no dead centre in the middle of the throw. This allows you to use the pitch stick for natural vibrato, pretty much like a guitarist or violin player can.

## PITCH BEND RANGE

The Pitch bend range is set globally for the entire instrument. It’s possible to set different bend ranges for Down and Up. To set the bend ranges for the PITCH STICK or to incoming Pitch Bend MIDI data, proceed as follows:

1. Press the SYNTH button and then the DOWN NAVIGATOR button till the DISPLAY reads ‘Bend Range’.



2. Change the bend ranges, in semitones, with the ROTARY DIAL. Switch between Down and Up with the RIGHT and LEFT NAVIGATOR buttons. The maximum range is +/-12 semitones.

- Exit by pressing the SYNTH button.

**Note:** You can choose to enable/disable the Pitch Stick/Pitch Bend function separately for each Slot. This is especially useful when you are creating a Performance and only want some Slots to respond to pitch bend information. See “Active Device” on page 116.

## MODULATION WHEEL

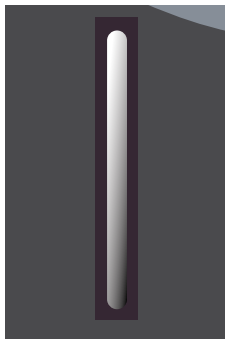

The effect of moving the MODULATION WHEEL can be different for each Program. You decide what you want it to affect in each Program or Performance part by assigning parameters to the Wheel Morph function described in Chapter "5. Morph groups" on page 29. You can also use the MODULATION WHEEL to control the global Vibrato described on page 105.

**Note:** You can choose to enable/disable the Modulation Wheel/Mod Wheel MIDI data separately for each Slot. This is especially useful when you are creating a Performance and only want some Slots to respond to Modulation Wheel. See “Active Device” on page 116.

## ACTIVE DEVICE



To the right of the PITCH STICK (above the Morph Assign buttons on the Nord Rack 3) is the Active Device function. In this section you can choose to disable certain physical (and MIDI) controllers from affecting the sound. This is a great function when you play layered sounds with several Slots selected like in a Performance, for example. The Active Device settings are also saved with Performances.

### **P.STICK, S.PEDAL+HOLD AND WHEEL SELECTOR**

You can choose to disable the PITCH STICK, the SUSTAIN PEDAL + HOLD and/or the MODULATION WHEEL functions. Press the SELECTOR button to select/deselect functions. To disable/enable MODULATION WHEEL, hold down SHIFT and press the SELECTOR button.

**Tip!** This function can be very useful in multi Slot Performances when you want to control, for example, pitch bend of a sound in one Slot but not in another. Or when you want the Hold function to affect only specific sounds in the layer.

## MENU FUNCTIONS



To access the Menu functions, first press the main menu button (MASTER CLOCK, MIDI, SYNTH, SOUND) and then step down in the sub-menus by pressing the DOWN NAVIGATOR button.

### MASTER CLOCK



Press the MASTER CLOCK button to enter the Master Clock functions menu.

### CLOCK SOURCE AND TEMPO



OR



Here you select between Internal and External Clock sync. Select by turning the ROTARY DIAL. Press the RIGHT NAVIGATOR button and set the tempo (in BPM) with the ROTARY DIAL.

**Note:** If you have selected External sync, the Arpeggiator and LFOs (if Clock sync is activated) are synced to incoming MIDI Clock signal. If no MIDI Clock signal is received, the Arpeggiator and LFOs will automatically sync to the internal Master Clock. If you have selected Internal sync, the Arpeggiator and LFOs will ignore any incoming MIDI Clock signal and always sync to the internal Master Clock.

**Note:** Don't forget to use the 'store System Settings' function of the Synth menu described on [page 128](#) before powering off Nord Lead 3. Otherwise the changes you have made in the Master Clock menu won't be recalled the next time you power up.

**SEND MIDI CLOCK**

Here you can enable/disable transmission of MIDI Clock data. Select On or Off by turning the ROTARY DIAL. When you enable the MIDI Clock transmission, a MIDI Clock Start message will also be transmitted. When you disable the MIDI Clock transmission, a MIDI Clock Stop message will also be transmitted.

**Note:** Don't forget to use the 'store System Settings' function of the Synth menu described on [page 128](#) before powering off Nord Lead 3. Otherwise the changes you have made in the Master Clock menu won't be recalled the next time you power up.

**KEYBOARD SYNC**

You can also choose to sync the Master Clock to key presses. This is very useful if you are controlling both the Arpeggiator and the LFOs from the Master Clock. Press the DOWN NAVIGATOR.button.



Select Clock Key Sync (On/Off) by turning the ROTARY DIAL. When Clock Key Sync is On it means that as soon as you press new key(s) after having released the previous one(s), the Master Clock restarts immediately. When Clock Key Sync is Off it means that as soon as you press a new key the arpeggio will continue at the next Master Clock signal. Press the MASTER CLOCK button to exit.

**Note:** Don't forget to use the 'store System Settings' function of the Synth menu described on [page 128](#) before powering off Nord Lead 3. Otherwise the changes you have made in the Master Clock menu won't be recalled the next time you power up.



## MIDI



The MIDI menu contains all MIDI related functions of Nord Lead 3.

**Note:** Don't forget to use the 'store System Settings' function of the Synth menu described on [page 128](#) before powering off Nord Lead 3. Otherwise the changes you have made in the MIDI menu won't be recalled the next time you power up.

## SLOT CHANNELS



Here you set the MIDI channel for each of the four Slots of Nord Lead 3. Select Slot with the **RIGHT/LEFT NAVIGATOR** button or by pressing the corresponding **SLOT** button. Select MIDI channel for the selected Slot with the **ROTARY DIAL**.

Range: 1-16, -- (off)

**Note:** If a Slot MIDI channel happens to be set to the same number as the Global MIDI channel (see below), the Performance takes precedence regarding Program Change messages. That is, Program Change messages received on the Global MIDI channel will select Performances, not Programs. If you are in Program Mode, the Performance will change "in the background" and be ready to play when you switch to Performance Mode.

**Note:** Don't forget to use the 'store System Settings' function of the Synth menu described on [page 128](#) before powering off Nord Lead 3. Otherwise the changes you have made won't be recalled the next time you power up.

**MIDI GLOBAL**

Here you set the Global MIDI Channel of Nord Lead 3. The Global MIDI Channel should be used for sending and receiving MIDI Program Change messages when in Performance mode (see [Chapter "6. Performances" on page 32](#)). Select Global MIDI Channel with the ROTARY DIAL.

Range: Channel 1-16, -- (off)

**Note:** Don't forget to use the 'store System Settings' function of the Synth menu described on [page 128](#) before powering off Nord Lead 3. Otherwise the changes you have made won't be recalled the next time you power up.

**LOCAL**

Here you set whether the Nord Lead 3 keyboard and front panel controllers should control internal Programs/Performances or only send MIDI. Local On is the normal "play mode". In Local Off mode, the front panel and keyboard actions are transmitted via MIDI only and does not control the internal sound(s) at all. (The MIDI In works as usual, though.)

Local Off should be used when you use a sequencer to record and play back from Nord Lead 3. When using a sequencer, you connect the MIDI Out of Nord Lead 3 to the sequencer's MIDI In. Then, from the sequencer's MIDI Out back to the Nord Lead 3's MIDI In. Since the sequencer echoes back incoming MIDI data, Nord Lead 3 will respond normally to your playing and knob tweaking via the MIDI "loop".

If you use Local On in the sequencer setup described above, you will get double-notes when you play: from the keyboard internally and via the MIDI "loop". This is not what you want. Therefore, always use Local Off together with sequencers.

Select Local On or Local Off with the ROTARY DIAL.

**Note:** Don't forget to use the 'store System Settings' function of the Synth menu described on [page 128](#) before powering off Nord Lead 3. Otherwise the changes you have made won't be recalled the next time you power up.

**PROGRAM CHANGE & MIDI CONTROLLERS**

Here you set the how MIDI Program Change and MIDI Controller messages should be dealt with. Select PrgChg or MIDI Ctrl with the **RIGHT/LEFT NAVIGATOR** button. Select mode for the selected function with the **ROTARY DIAL**.

Modes:

Program Change: Send, Receive, Send&Receive, Off

MIDI Controllers: Send, Receive, Send&Receive, Off

**Note:** Don't forget to use the 'store System Settings' function of the Synth menu described on [page 128](#) before powering off Nord Lead 3. Otherwise the changes you have made won't be recalled the next time you power up.

**SEND MIDI CONTROLLERS**

Consider a situation where you record a Controller message, e.g. a filter opening, in the middle of your sequencer song. Then you “rewind” the sequencer to a position before the recorded filter opening. The problem is that the Nord Lead’s filter will remain opened, although it really should be as it was before you recorded the filter opening. To solve such problems, several sequencers include a function called “Controller Chasing”, which keeps track of Controller changes and tries to adjust the settings on the instrument according to the current position in the sequencer song.

However, in our example this wouldn't help much, because the filter opening was the first Controller message recorded in the song. The sequencer has no information about the filter setting before the recorded change, and therefore cannot “chase” the settings properly. To solve this, you could record a “snapshot” of all Controller settings of the Nord Lead 3 Program(s) at the beginning of your sequencer song.

Here you can send a “snapshot” of all MIDI Controllers of the Program in the currently selected Slot. Select Slot with the **ROTARY DIAL** or by pressing the corresponding **SLOT** button. Press the **RIGHT NAVIGATOR** button to send all Controllers to the MIDI Out of Nord Lead 3.

**INSTRUMENT SYSEX ID**

Here you can set an ‘Instrument SysEx ID’. This is very useful if you’re sending SysEx dumps of sounds from a sequencer to Nord Lead 3 and have several Nord Lead synthesizers MIDI connected. Let’s say you have two Nord Lead synthesizers; one Nord Lead 3 and one Nord Lead 2. These two instrument models have the same ‘Manufacturer ID’ and ‘Model ID’ in the SysEx protocol. By defining a SysEx ID on Nord Lead 3, you will be able to “direct” the SysEx dumps from the sequencer to Nord Lead 3, while the Nord Lead 2 will ignore the dumps. Just make sure that you define a SysEx ID that is not the same as the Nord Lead 2s ‘Global Midi Channel’ before dumping the sound to the sequencer. Select Instrument SysEx ID with the **ROTARY DIAL**.

Range: 1-127, All

**Note:** Don’t forget to use the ‘store System Settings’ function of the Synth menu described on [page 128](#) before powering off Nord Lead 3. Otherwise the changes you have made won’t be recalled the next time you power up.

**DUMP ONE**

Hold **SHIFT** and press the **MIDI** button to send a MIDI SysEx dump of the currently active Program or Performance (depending on in which mode you are) to the MIDI Out of Nord Lead 3. This function is very useful when you are working with an external sequencer and want to record the Program or Performance data to the sequencer. The MIDI SysEx data also contains information about from which Slot the Program was sent. This ensures that when you play back the sequence, the Program and will end up in its original Slot. For information on what data a single MIDI SysEx dump contains, see [“Program Dumps” on page 147](#) and [“Performance Dump” on page 151](#).

For information on how to send a MIDI SysEx dump of an entire Program or Performance Bank, see [“Program Bank Dump” on page 125](#) and [“Performance Bank Dump” on page 127](#).

## SYNTH



All functions in the Synth menu are global for the entire instrument. Any changes you make will affect all Programs/Performances/Slots etc. of Nord lead 3.

**Note:** Don't forget to use the 'store System Settings' function described on [page 128](#) before powering off Nord Lead 3. Otherwise the changes you have made in the Synth menu won't be recalled the next time you power up.

### MASTER TUNE.

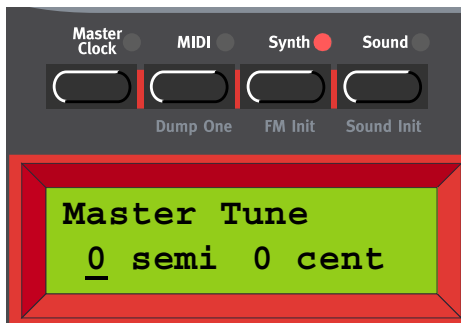

Here you change the global Master Tune setting for the Nord Lead 3. Change the master tune, in semitones, with the ROTARY DIAL. '0' is normal 440Hz tuning. The range is +/- 6 semitones in steps of 1 semitone. Press the RIGHT NAVIGATOR button to change the Master Tune, in cents, with the ROTARY DIAL. The range is +/- 1 semitone in steps of 1 cent (hundreds of a semitone).

**Note:** Don't forget to use the 'store System Settings' function described on [page 128](#) before powering off Nord Lead 3. Otherwise the changes you have made won't be recalled the next time you power up.

### PITCH BEND RANGE



Here you set the bend ranges for the PITCH STICK and for incoming MIDI Pitch Bend data. It's possible to set different pitch bend ranges for Down and Up. Change the bend ranges, in semitones, with the ROTARY DIAL. Switch between Down and Up with the RIGHT and LEFT NAVIGATOR buttons.

Range: +/-12 semitones in steps of 1 semitone

**Note:** Don't forget to use the 'store System Settings' function described on [page 128](#) before powering off Nord Lead 3. Otherwise the changes you have made won't be recalled the next time you power up.

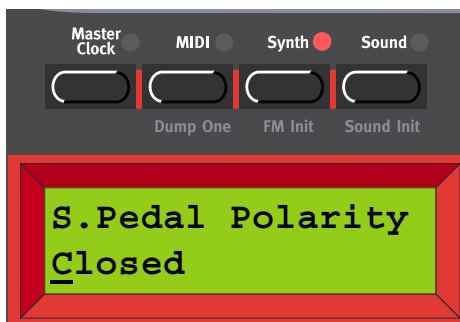
**SUSTAIN PEDAL POLARITY**

Here you set the Sustain Pedal polarity when you have a sustain pedal connected to the SUSTAIN PEDAL INPUT on the rear panel of Nord Lead 3. Change Sustain Pedal polarity between ‘Open’ (open when pressed) and ‘Closed’ (closed when pressed) with the ROTARY DIAL.

**Note:** Don’t forget to use the ‘store System Settings’ function described on [page 128](#) before powering off Nord Lead 3. Otherwise the changes you have made won’t be recalled the next time you power up.

**MORPH3 SOURCE**

Here you set how Morph group 3 should be routed when you use a control pedal. In ‘Auto’ mode Morph group 3 automatically switches from Aftertouch to Control Pedal as soon as a control pedal is plugged into Nord Lead 3. You can also choose to hardwire Morph group 3 to either Aftertouch or Control Pedal. Select mode with the ROTARY DIAL.

**Note** that the MIDI Controller also switches according to what you select, i.e. if Aftertouch is selected, Morph group 3 can be controlled by MIDI Channel Pressure. If you select Expression Pedal, Morph group 3 is instead controlled by MIDI CC#11 (Expression Pedal).

Range: Auto, Ctrl Pedal or Aft. Touch

**Note:** Don’t forget to use the ‘store System Settings’ function of the Synth menu described on [page 128](#) before powering off Nord Lead 3. Otherwise the changes you have made won’t be recalled the next time you power up.

**AUDIO ROUTING**

Here you set the Audio Routing for **SLOT A-D**, i.e. how the four Slots should route the audio to the physical outputs of Nord Lead 3 (see “[Connections](#)” on page 10). Select Slot with the **RIGHT/LEFT NAVIGATOR** button or by pressing the corresponding **SLOT** button. Change Audio Routing with the **ROTARY DIAL**.

Modes:

M1-M4: The Slot routes the audio in Mono to one of the outputs **OUT A-D**

S1: The Slot routes the audio in Stereo (if selected in the Program) to **OUT A** (left) and **OUT B** (right)

S2: The Slot routes the audio in Stereo (if selected in the Program) to **OUT C** (left) and **OUT D** (right)

**Note:** Don’t forget to use the ‘store System Settings’ function described on [page 128](#) before powering off Nord Lead 3. Otherwise the changes you have made won’t be recalled the next time you power up.

**PROGRAM BANK DUMP**

Here you can send a MIDI SysEx bulk dump of all Programs in a Bank to the **MIDI OUT** of Nord Lead 3. This is the function to use when you want to back up your sounds on a computer/sequencer or when you want to copy a Bank to another Nord Lead 3. Select Bank to dump with the **ROTARY DIAL**. Press the **RIGHT NAVIGATOR** button to start dumping the content of the selected Program Bank. As the Program Bank Dump proceeds, the names of the Programs and their memory locations are shown in the

DISPLAY. When the Program Bank Dump is complete, the DISPLAY shows the message 'Program Dump Completed':

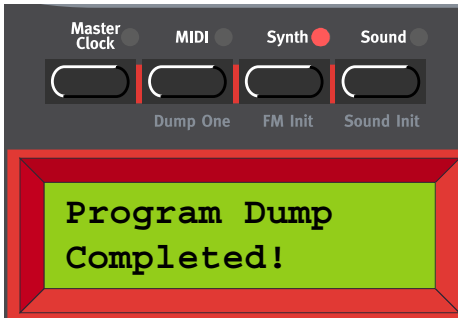

Press the SYNTH button or any NAVIGATOR button to exit.

### PROGRAM BANK RECEIVE

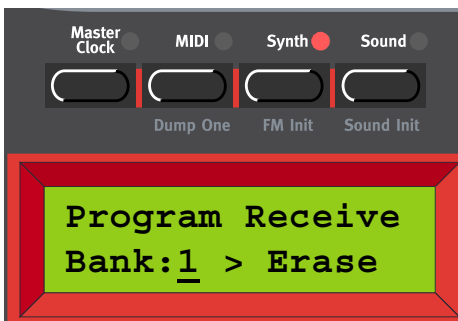

This function should be used when you want to download a MIDI SysEx Bank file and replace a Bank of Programs in Nord Lead 3. To be able to receive a MIDI SysEx Bank file via the MIDI In of Nord Lead 3 you must first select and erase the content of the Bank you want to replace. Select Bank to erase with the ROTARY DIAL. Press the RIGHT NAVIGATOR button twice to erase the selected Bank and prepare for MIDI SysEx reception to the selected (erased) Bank.

**Note:** pressing the RIGHT NAVIGATOR button the second time will permanently erase the content of the selected Bank. Make sure you don't erase Programs that you want to keep!

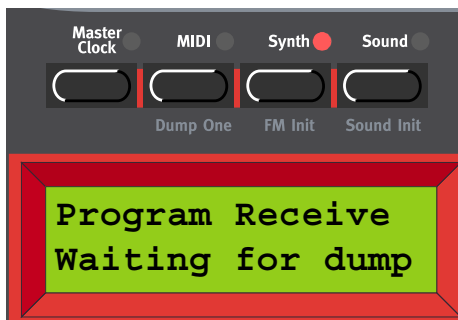

Now, all Programs of the selected Bank are erased and Nord Lead 3 is waiting for the MIDI SysEx dump to be received. Initiate the dump at the sending device (another Nord Lead 3, a MIDI sequencer or similar). As the MIDI SysEx reception proceeds, the names of the Programs and their memory locations are shown in the DISPLAY. When the dump reception is complete, the DISPLAY shows the last received Program Press the SYNTH button or any NAVIGATOR button to exit.



Note: a Bank file that you download to Nord Lead 3 doesn't have to contain 128 Programs. If it contains less than 128 Programs, these will be downloaded and the rest of the memory locations in the selected Bank will be left empty.

#### PERFORMANCE BANK DUMP



Here you can send a MIDI SysEx bulk dump of all Performances in a Bank to the MIDI OUT of Nord Lead 3. This is the function to use when you want to back up your sounds on a computer/sequencer or when you want to copy a Bank to another Nord Lead 3. Select Bank to dump with the ROTARY DIAL. Press the RIGHT NAVIGATOR button to start dumping the content of the selected Performance Bank. As the Performance Bank Dump proceeds, the names of the Performances and their memory locations are shown in the DISPLAY. When the Performance Bank Dump is complete, the DISPLAY shows the message 'Performance Dump Completed':



Press the SYNTH button or any NAVIGATOR button to exit.

#### PERFORMANCE BANK RECEIVE



This function should be used when you want to download a MIDI SysEx Bank file and replace a Bank of Performances in Nord Lead 3. To be able to receive a MIDI SysEx Bank file via the MIDI In of Nord

Lead 3 you must first select and erase the content of the Bank you want to replace. Select Performance Bank to erase with the **ROTARY DIAL**. Press the **RIGHT NAVIGATOR** button twice to erase the selected Bank and prepare for MIDI SysEx reception to the selected (erased) Bank.

**Note:** pressing the **RIGHT NAVIGATOR** button the second time will permanently erase the content of the selected Bank. Make sure you don't erase Performances that you want to keep!

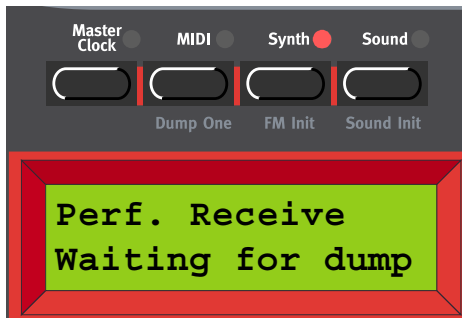

Now, all Performances of the selected Bank are erased and Nord Lead 3 is waiting for the MIDI SysEx dump to be received. Initiate the dump at the sending device (another Nord Lead 3, a MIDI sequencer or similar). As the MIDI SysEx reception proceeds, the names of the Performances and their memory locations are shown in the **DISPLAY**. When the dump reception is complete, the **DISPLAY** shows the last received Performance. Press the **SYNTH** button or any **NAVIGATOR** button to exit.

**Note:** a Bank file that you download to Nord Lead 3 doesn't have to contain 128 Performances. If it contains less than 128 Performances, these will be downloaded and the rest of the memory locations in the selected Bank will be left empty.

#### SYSTEM SETTINGS

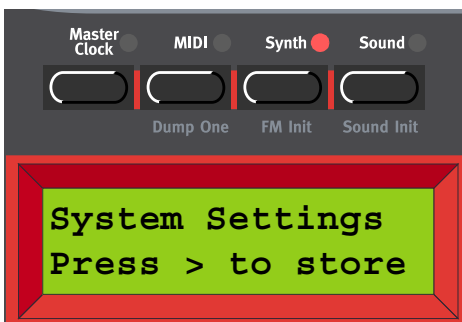

Here you store all parameter values of the Synth menu as well as a number of other settings including what Programs should be loaded in each Slot, which Slot should be active/selected, MIDI settings, Master Clock settings etc. Press the **RIGHT NAVIGATOR** button to store System Settings to the internal Flash memory of Nord Lead 3.

**Note:** If you don't store the System Settings before powering off Nord Lead 3, the previously stored System Settings will be recalled at the next power-up.

**MEMORY PROTECT**

Here you can choose to write-protect all Programs and Performances. Select Memory Protect On or Off with the ROTARY DIAL.

**Note!** When Nord Lead 3 is shipped from factory, Memory Protect is set to 'On'. To be able to store Programs and Performances, set Memory Protect to 'Off'.

**Note:** Don't forget to use the 'store System Settings' function described on [page 128](#) before powering off Nord Lead 3. Otherwise the changes you have made won't be recalled the next time you power up.

**FM INIT**

If you want to create a sound from "scratch" and don't want to start by editing an existing Program, there are two functions that make it much easier to get started: 'Sound Init' and 'FM Init'. 'Sound Init' can be used when you want to create an "analog-style" subtractive sound and 'FM Init' when you want to create an FM sound. 'Sound Init' and 'FM Init' automatically resets all sound editing parameters to a basic default setting. From here it's often easier to start with the editing than from an existing Program. Hold down SHIFT and press the SYNTH button to perform an 'FM Init'.

**Tip!**

To quickly get started with the FM sound creation, begin by tweaking these knobs:

- The AMOUNT knobs of the LFOs and Modulation Envelope. (The LFOs are set to 'Env' mode by default to make it possible to create nice FM attacks in the sound)
- The MODULATION knob of the Osc Mod section
- The SHAPE1, SHAPE2, COARSE (Carrier) and FINE (Modulator) knobs of the Oscillator section

## SOUND



All functions in the Sound menu can be selected and saved with each Program separately.

## ARP RANGE AND MODE

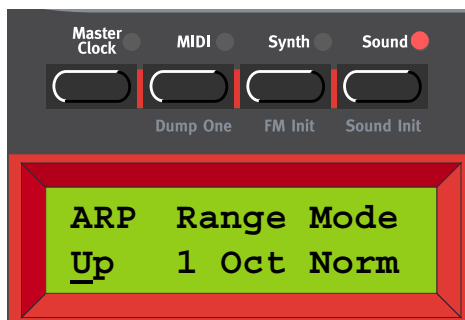

Select main Arpeggio direction by turning the **ROTARY DIAL**. You can select between Up, Down, Up&Down and Random. Press the **RIGHT NAVIGATOR** button to select Range (the cursor will move to the right in the **DISPLAY**). Select Range (1-4 Octaves) by turning the **ROTARY DIAL**. Press the **RIGHT NAVIGATOR** button again to select Mode (Normal, Sub, Mask and Sub+Mask)

Directions: Up, Down, Up&Down and Random

Range: 1-4 Octaves

Mode: Normal, Sub, Mask and Sub+Mask

See [page 97](#) for more details about the Arpeggiator.

## ARP SUBMODE



Press the **DOWN NAVIGATOR** button to enter the Sub Arpeggio menu. Here you can select between Up, Down, Up&Down, Random and Still. Press the **RIGHT NAVIGATOR** button to select Range (the cursor will move to the right in the **DISPLAY**). Select Range (1-8 keys/notes) by turning the **ROTARY DIAL**

Directions: Up, Down, Up&Down, Random and Still

Range: 1-8 Notes/Keys

See [page 97](#) for more details about the Arpeggiator.

**Note!** For the Sub Arpeggio to work you must have selected either 'Sub' or 'Sub+M' in the main Arpeggio menu above.

### ARP MASK



Press the **DOWN NAVIGATOR** button to enter the ARP Mask menu. Here you can set the length of the Mask and enable/disable (mute/skip) steps in the arpeggio. Press the **LEFT/RIGHT NAVIGATOR** buttons until the cursor is below the L. Turn the **ROTARY DIAL** counter clockwise to set the length (1-16). Press the **RIGHT NAVIGATOR** button to begin editing the steps. Move between the steps with the **RIGHT/LEFT NAVIGATOR** buttons and disable/enable each step by turning the **ROTARY DIAL**. A filled dot means that the step is enabled and a circle means that the step is skipped (muted).

Length: 1-16 Steps

Mask: On (filled dots) or Off (circle)

See [page 97](#) for more details about the Arpeggiator.

**Note!** For the Arpeggio Mask to work you must have selected either 'Mask' or 'Sub+M' in the main Arpeggio menu above.

### VIBRATO AMOUNT AND RATE



Here you set the amount and frequency for the Vibrato function. Set the Vibrato amount by turning the **ROTARY DIAL**.

Range: +/- 1 semitone in steps of +/- 1 cent.

Press the **RIGHT NAVIGATOR** button once to change the Vibrato frequency. Select frequency with the **ROTARY DIAL**.

Range: 4.00-8.00 Hz.

See [page 105](#) for more info about Vibrato.

**PROGRAM NAME**

Here you can name your Program or part of a Performance. Select letters with the **ROTARY DIAL** and change the cursor position with the **RIGHT** and **LEFT NAVIGATOR** buttons. If you want to delete a letter/position and thus move all the letters to the right of the cursor one step back, hold down **SHIFT** and press the **LEFT NAVIGATOR** button. (This function is the same as using the Delete key on a computer keyboard.) If you want to move all letters to the right of the cursor one step forward and thus make room for more letters, hold down **SHIFT** and press the **RIGHT NAVIGATOR** button.

**Note!** Don't forget to save your Program/Performance after you renamed it.

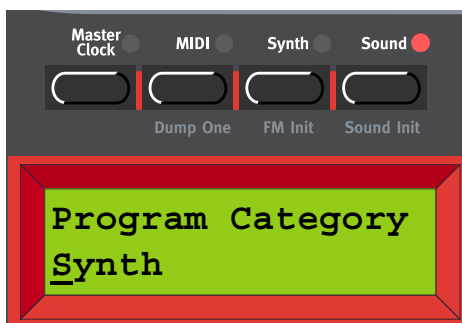
**PROGRAM CATEGORY**

Here you can select a Category for your Program. Select Program Category with the **ROTARY DIAL**. Please refer to [page 24](#) for more detailed info about using Program Categories.

**Note!** Don't forget to save your Program after you changed the Category.

**SOUND INIT**

If you want to create a sound from “scratch” and don't want to start by editing an existing Program, there are two functions that make it much easier to get started: ‘Sound Init’ and ‘FM Init’. ‘Sound Init’ can be used when you want to create an “analog-style” subtractive sound and ‘FM Init’ when you want to create an FM sound. ‘Sound Init’ and ‘FM Init’ automatically resets all sound editing parameters to a basic default setting. From here it's often easier to start with the editing than from an existing Program. Hold down **SHIFT** and press the **SOUND** button to perform a ‘Sound Init’.

## USEFUL FUNCTIONS

### MONITOR

To see the exact value of any parameter surrounded by a circular LED graph, press and hold the **MONITOR/COPY** button and turn the knob of the parameter you wish to monitor. The parameter's value won't change as you turn the knob - it will only put the parameter "in focus". The exact value is shown, with the corresponding unit, in the **DISPLAY**.

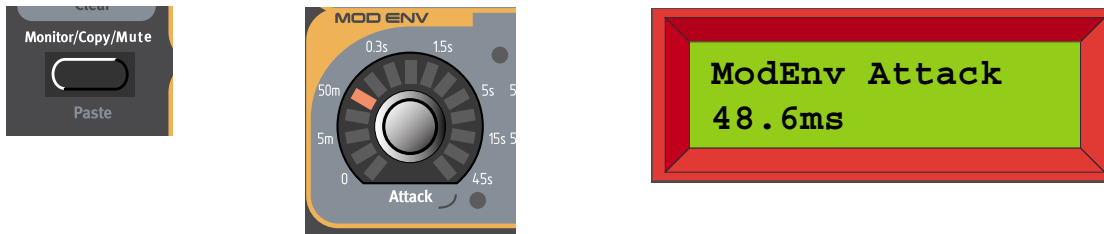

*Press and hold down the **MONITOR/COPY** button and turn a **KNOB**. The **DISPLAY** shows the selected parameter and its current exact value.*

### COPY & PASTE

#### COPY AND PASTE PARAMETERS

Another very useful functionality is the Copy and Paste function. This function lets you copy the value of the last monitored parameter and paste it to another parameter. The procedure is the same as for the Monitor function, i.e. press and hold the **MONITOR/COPY** button and turn the knob of the parameter you wish to copy. Then release the button. Press and hold **SHIFT+MONITOR/COPY** (Paste) and turn the knob of another parameter to paste the value to it. This can be very useful if you want to have exactly the same values on several parameters, Attack times for example.

**Note that the copied parameter value is always buffered as a value between 0 and 127. This makes it possible to copy, for example, an Attack time and paste it into a corresponding Sustain value or LFO rate.**

#### COPY AND PASTE A MORPH GROUP

The Copy/Paste function can also be used to copy an entire Morph Group with all its assigned parameters from one Morph source to another. To copy and paste a Morph Group, do like this:

Press and hold the **MONITOR/COPY** button and while holding it press a **MORPH GROUP** button. Release all buttons. Press and hold **SHIFT+MONITOR/COPY** (Paste) and while holding them press the destination **MORPH GROUP** button.

#### COPY AND PASTE PROGRAMS BETWEEN SLOTS

You can also copy a Program (sound) from one Slot and paste it to another Slot. To copy and paste a Program, do like this:

Press and hold the **MONITOR/COPY** button and while holding it press the **SLOT** button containing the Program you want to copy. Release all buttons. Press and hold **SHIFT+MONITOR/COPY** (Paste) and while holding them press the destination **SLOT** button.

## MUTE

### MUTING PARAMETER SECTIONS

When you're editing a Program it may sometimes be convenient to temporarily mute certain parameter sections so you can hear how they affect the sound



By holding the **MONITOR/COPY/MUTE** button and pressing any of the following **SELECTOR** buttons, the selected parameter section is temporarily muted (disabled): **LFO1 or 2 DESTINATION**, **MOD ENV DESTINATION**, **OSC1 or 2 WAVEFORM**, **OscMod MODE** and **Filter TYPE**.

A muted parameter section is indicated by the corresponding **SELECTOR LED** flashing.

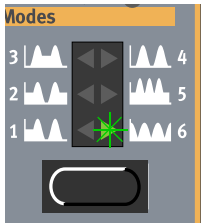

To revert to normal state, and thus activate the parameter section/function again, press the corresponding **SELECTOR** button or the **MONITOR/COPY/MUTE** button together with the corresponding **SELECTOR** button.

**Note! You cannot store any Mute settings with the Program.**



### SPECIAL INFORMATION IN THE DISPLAY

When editing a Program (sound), the DISPLAY shows the exact value of the currently edited parameter as described earlier. In some specific situations the DISPLAY also gives other useful information:

#### SAME PARAMETER TYPES

When editing the LFO1 or LFO2 Rate parameters, a '\*' or '/' sign and a number is shown next to the parameter name in the DISPLAY. This indicates the relationship between the LFO1 and LFO2 Rate settings. This information can be useful if you want to have a specific relationship between the LFO Rates.

The formula is: LFO1 Rate \* x.xx = LFO2 Rate

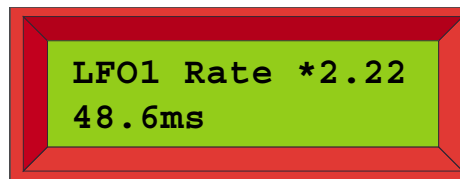
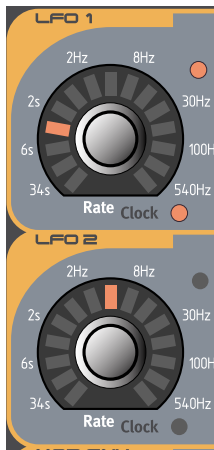

The same happens when you edit the Frequency1 or Frequency2 parameters when in Multi Filter Modes in the Filter section.

The formula in the filter case is: Frequency1 \* x.xx = Frequency2



If you turn the FREQUENCY1 knob, the Display will show the Frequency1 value and the relationship to Frequency2. In this example Frequency1 is 1/6.349 of Frequency2.

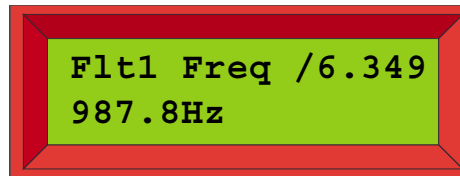

If you turn the FREQ2/DIST knob, the Display will show the Frequency2 value and the relationship to Frequency1. In this example Frequency2 is 6.349 times Frequency1.



**KEYBOARD MORPH**

Keyboard Morph lets you control the morphed parameters differently depending on where on the keyboard you play. This function makes it easy to create, for example, "custom made" Filter Keyboard Tracking. When you assign cutoff frequency to Keyboard Morph, the DISPLAY also shows the actual keyboard tracking in %. Just make sure you deselect the KB Track function in the filter section to make this work as intended.



You can also use this special information in the Display for "custom keyboard tracking" of the Frequency2 parameter in Multi Filter Mode, the Rate parameters of LFO1 and LFO2 and of the Coarse parameter of Oscillator 2. Make sure you deselect the KB Track function in the Oscillator2 section to make the % figure correspond to reality. See [Chapter "5. Morph groups" on page 29](#) for information about using Morph groups.

# 8. FACTORY PRESETS AND OS

## FLASH MEMORY

The Operating System as well as all factory Programs and Performances of Nord Lead 3 are stored in Flash memory. A Flash memory is a type of “memory resistant” RAM which means it keeps the data also when the power is shut off. Another big advantage is that you can replace data in the Flash memory at any time. This means that you will be able to download OS upgrades and sounds to your Nord Lead 3 from a computer or sequencer without needing to replace or add any new hardware.

The internal sound memory of Nord Lead 3 consists of 8 Banks (1-8) holding 128 Programs each for a total of 1024 Programs plus 2 Banks (1-2) holding 128 Performances each for a total of 256 Performances.

**Note that the four Slots of Nord Lead 3 are not hard-wired to any specific Banks or memory locations. All four Slots share the same internal memory. In other words, a given Program will sound the same regardless of what Slot it's loaded to.**

## FACTORY PRESETS

All factory Programs and Performances of Nord Lead 3 can be replaced. To make sure you don't accidentally overwrite Sounds or Performances you want to keep, it's a good idea to back up your sounds regularly on a computer or on a hardware sequencer that can record and play back MIDI SysEx. data. For information on how to back up Programs and Performances, please refer to [“Send a Bank Dump” on page 142](#).

### RESTORING THE FACTORY PRESETS

The factory Program Banks and the factory Performance Bank are available as MIDI SysEx files for download at the Clavia web site at [www.clavia.se](http://www.clavia.se). Please refer to [“Receive a Bulk Dump” on page 142](#) for information on how to restore the factory presets.

## OS UPGRADES

The latest OS version for Nord Lead 3 is available for download at [www.clavia.se](http://www.clavia.se).

# 9. BASIC MIDI FUNCTIONS

## ABOUT THE MIDI IMPLEMENTATION

The following MIDI messages can be transmitted and received from Nord Lead 3:

### NOTE ON/OFF

- Note On and Note Off messages are of course transmitted when you play the keyboard. If you use the OCTAVE SHIFT buttons in 'Keyboard Octave Shift' mode (see [“Octave Shift” on page 111](#)), you can transpose the Nord Lead 3 keyboard  $\pm 2$  octaves, giving you an effective note range of 8 octaves.
- Notes can be received over the entire MIDI Note range. That is, when controlling Nord Lead 3 from MIDI, you have access to a pitch range wider than 10 octaves.

### PITCH BEND

- Pitch Bend messages are always transmitted from the Pitch Stick. The Pitch Bend range (important when receiving Pitch Bend messages) can be adjusted, see [“Pitch bend range” on page 123](#).

### CONTROLLERS

- The Modulation Wheel data is transmitted and received as Controller 1 (Modulation wheel).
- If you have an Control/Expression pedal connected to the Control Pedal input, this is transmitted and received as Controller 11 (Expression).
- If you have a Sustain pedal connected, this is transmitted and received as Controller 64 (Sustain Pedal).
- All other controls (knobs and buttons) on the front panel (except Master Level), are also transmitted and received as Control Change messages. This can be used to record your actions on the front panel into a MIDI sequencer. For a full list of which parameters correspond to which Controller number, see the MIDI implementation chapter on [page 143](#).

You can activate and deactivate the transmission/reception of MIDI Controllers in Nord Lead 3. See [“Program Change & MIDI Controllers” on page 121](#).

### AFTERTOUCH

Nord Lead 3 can transmit and receive Aftertouch (Channel Pressure) messages. You can set which parameters (if any) should be controlled by the Aftertouch messages individually for each Program and Performance. See [Chapter "5. Morph groups” on page 29](#).

## PROGRAM CHANGE

The descriptions below are true only if transmission/reception of Program Change messages is activated, see [“Program Change & MIDI Controllers” on page 121](#).

- When you load a Program in a Slot, a Program Change message is transmitted via MIDI on the Slot’s MIDI Channel. If a Program Change message is received on a certain MIDI Channel, the Slot(s) set to receive on that MIDI Channel will change Program accordingly.
- When you select a Performance, a Program Change message is transmitted on the Global MIDI Channel. For information on how to set the Global MIDI Channel, see [page 120](#). When a Program Change message is received on the Global MIDI Channel, a new Performance is selected.  
Note that if you are in Program mode and receive a Program Change message on the Global MIDI channel (the Performance MIDI channel), the new Performance will be loaded “in the background”. When you switch to Performance mode, the new Performance will be ready to play.

If the Global MIDI Channel happens to be set to the same number as one of the Program Slots, the Performance takes precedence. That is, Program Change messages on the Global MIDI Channel will select Performances, not Programs.

## BANK SELECT

- Bank Select messages are transmitted and received as MIDI Controller 32. Bank Select with the value ‘0’ selects Program Bank 1, Bank Select number ‘1’ selects Program Bank 2 and so on up to Bank 8 (Bank Select value ‘7’).

A Bank Select message must always be followed by a Program Change message, or no Bank change will take place.

## MIDI SYSEX (SYSTEM EXCLUSIVE)

Program and Performance settings can be transmitted and received as a System Exclusive dump (see [“Dump One” on page 122](#)). You can also dump complete Program Banks or the Performance Bank as a “bulk dump”. See [“Program Bank Dump” on page 125](#) and [“Performance Bank Dump” on page 127](#).

# USING NORD LEAD 3 WITH A SEQUENCER

## CONNECTIONS

1. Connect the MIDI Out on the Nord Lead 3 to the MIDI In on your sequencer.
2. Connect the MIDI Out from your sequencer to the MIDI In on the Nord Lead 3.

## LOCAL ON/OFF

If your sequencer “echoes” all received MIDI signals via its MIDI Output(s) (which it probably does. Look for a function called “MIDI Thru”, “MIDI Echo”, “MIDI Merge”, “Soft Thru” or similar), the Nord Lead 3 should be set to Local Off. This is important because otherwise you will get “double-notes”; from the internal keyboard and via MIDI. See [“Local” on page 120](#).

## MIDI CHANNELS

- Which MIDI channel the Nord Lead 3 transmits on depends on which of the four Program slots is active (see “Using the Slots” on page 13).
  - All four Slots always receive MIDI, regardless of which one is selected or if layering of more Slots is activated or not.
1. Set up the Slots you plan to use so that they transmit/receive on the desired MIDI channels. See “Slot Channels” on page 119 for details on how to set up MIDI channels for the Slots.
  2. Set the MIDI channel of the Slots you don’t want to use, to ‘Off’. This is to ensure they don’t play any sound unintentionally. See “Slot Channels” on page 119 for details on how to set up MIDI channels for the Slots.
  3. Select the desired Program for each Slot.
  4. If needed, set the sequencer up to record and play back on the desired MIDI Channel.
  5. Activate recording and play the Nord Lead 3.
  6. To overdub with a new sound, just select a new Track and a new MIDI Channel in the sequencer.

## PROGRAM CHANGE & BANK SELECT

For the Nord Lead 3 to transmit and receive Program Change and Bank Select (MIDI CC# 32) messages, Program Change must be activated, (see “Program Change & MIDI Controllers” on page 121).

- To record a Bank Select message and Program Change for a certain Slot, activate recording in the sequencer and simply select a new Program for the Slot. The Bank Select message will always be transmitted prior to the Program Change message.
- To record a Bank Select message and Program Change of a Performance, go into Performance mode, activate recording in the sequencer and select the Performance from the front panel. The Bank Select message will always be transmitted prior to the Program Change message.

When playing back the Bank Select message and Performance Program Change message from the sequencer, make sure it gets transmitted on the Nord Lead’s Global MIDI Channel and that the Nord Lead 3 is in Performance mode. (see “Performances” on page 17 and “MIDI Global” on page 120).

## CONTROLLERS

For the Nord Lead 3 to transmit and receive Control Change messages it must be activated, see “Program Change & MIDI Controllers” on page 121. Modulation Wheel and Pedal data, however, are always transmitted/received.

When you record Knob movements, make sure you have the right Program slot activated, and that the sequencer “echoes” the changes back on the right MIDI Channel, or your changes will affect the wrong sound! If two (or more) Slots are set to receive on the same MIDI Channel, all Programs in these Slots will be affected by the changes!

Please read the note about Controller transmission in Local Off mode in “Local” on page 120.

## MIDI CLOCK

When syncing the LFOs and/or the Arpeggio to external MIDI Clock, MIDI Song Position pointer is used. This means that when you record in an external sequencer, it will play back the Arpeggio pattern and/or LFO cycle exactly the way they were recorded - even if you start the sequencer in the middle of the sequence. Please refer to [“Master Clock” on page 117](#) for more info about syncing to external MIDI Clock.

## SOME NOTES ABOUT CONTROLLERS AND “CHASING”

Consider a situation where you record a Controller message, e.g. a filter opening, in the middle of your sequencer song. Then you “rewind” the sequencer to a position before the recorded filter opening. The problem is that the Nord Lead’s filter will remain opened, although it really should be as it was before you recorded the filter opening. To solve such problems, several sequencers include a function called “Controller Chasing”, which keeps track of Controller changes and tries to adjust the settings on the instrument according to the current position in the sequencer song.

However, in our example this wouldn’t help much, because the filter opening was the first Controller message recorded in the song. The sequencer has no information about the filter setting before the recorded change, and therefore cannot “chase” the settings properly. To solve this, you could record a “snapshot” of all Controller settings of the Nord Lead 3 at the beginning of your sequencer song. This can be done in two ways:

- by manually using the ‘Send MIDI Controllers’ function of the MIDI menu described on [page 121](#).
- by sending an “All Controllers Request” SysEx message from the sequencer to the Nord Lead 3, which will respond by dumping all its Controller values into the sequencer for recording. The “All Controllers Request” message is described on [page 155](#).

## PROGRAM/PERFORMANCE SYSEX DUMPS

### SEND A SINGLE PROGRAM/PERFORMANCE DUMP

To dump a single Program or Performance via MIDI as SysEx data, to another Nord Lead 3 or for recording the data into another MIDI device, do like this:

1. Connect a cable from MIDI OUT on the Nord Lead 3 to MIDI In on the other device.
2. Set up the receiving device so that it accepts MIDI SysEx data.
3. Select the Program or Performance you want to dump by simply loading it to a Slot (in Program mode or Performance mode depending on what you want to send)
4. If needed, set the destination MIDI device to “recording mode”.
5. Press SHIFT+MIDI (Dump One).

### **SEND A BANK DUMP**

To dump complete Banks of Programs or Performances via MIDI as System Exclusive data, to another Nord Lead 3 or for recording the data into another MIDI device, do like this:

1. Connect a cable from **MIDI OUT** on the Nord Lead 3 to **MIDI In** on the other device.
2. **Set up the receiving device so that it accepts MIDI SysEx data.**
3. Press the **SYNTH** button and scroll down to the Program Dump menu or Performance Dump menu depending on what type of Bank you want to send.
4. Select Bank with the **ROTARY DIAL**.
5. If needed, set the destination MIDI device to “recording mode”.
6. press the **RIGHT NAVIGATOR** button to dump all the Programs/Performances of the selected Bank.

### **RECEIVE A BULK DUMP**

To receive a MIDI SysEx Dump, do like this:

1. Connect a cable from **MIDI Out** on the transmitting device to **MIDI IN** on the Nord Lead 3.
2. Make sure the ‘Memory Protect’ function is set to ‘Off’ (see [page 129](#)).
3. **If you are about to receive a complete Bank, you need to use the ‘Bank Receive’ function described on [page 126](#).**
4. Initiate the transmission on the transmitting device.

If the dump contained a complete Bank, it will replace the selected Bank in the Nord Lead 3. If the dump contained only one Program/Performance, this will be put in the Slot, and replace the Program/Performance currently loaded in that Slot/Slots. However, it is not saved permanently. To save it, use ‘Store’ or ‘Store as’ described on [page 23](#) and [page 36](#).



# 10. MIDI IMPLEMENTATION

## MIDI CONTROLLER LIST

The following is a list of the MIDI Controller numbers used for all **KNOBS** and **BUTTONS** on the front panel.

- The reception and transmission of MIDI Controllers can be turned on/off. See “[Program Change & MIDI Controllers](#)” on page 121.
- All parameters use the entire control range 0-127. For **BUTTONS** and for some other parameters the range is divided into equally big “sections” depending on the number of states of the parameter. For example, the Oscillator waveform selectors can have 6 different “positions” and are therefore divided into 6 equally large sections between the values 0 and 127.

Nord Lead 3 Parameter	MIDI Controller #	MIDI Controller Name
<b>“Play Control” parameters:</b>		
Modulation Wheel	1	Modulation Wheel
Octave Shift	17	General Purpose #2
Chord Memory On/Off	112	
<b>Voice mode parameters</b>		
(Stereo) Unison On/Off	16	General Purpose #1
(Stereo) Unison Detune	53	
Mono On/Off	15	Undefined
Mono (Hi/Lo Note Priority)	94	
Legato On/Off	111	
Glide Mode (Normal/Auto)	65	Portamento On/Off
Glide Rate	5	Portamento Time
Vibrato Rate	54	
Vibrato Amount	55	
Vibrato Source	56	
<b>Arpeggio parameters:</b>		
Arpeggio Run On/Off	47	
Arpeggio Rate	50	
Arpeggio Clock Sync On/Off	52	
Arpeggio Clock Sync Divisor	98	

<b>Nord Lead 3 Parameter</b>	<b>MIDI Controller #</b>	<b>MIDI Controller Name</b>
<b>LFO 1 parameters:</b>		
LFO 1 Rate	19	General Purpose #4
LFO 1 Waveform	20	Undefined
LFO 1 Destination	21	Undefined
LFO 1 Amount	22	Undefined
LFO 1 Clock Sync On/Off	81	
LFO 1 Keyboard Sync/Single Cycle	82	
LFO 1 Mono mode On/Off	83	
LFO 1 Amount Invert On/Off	84	
LFO 1 Clock Sync Devisor	99	
<b>LFO 2 parameters:</b>		
LFO 2 Rate	23	General Purpose #4
LFO 2 Waveform	85	Undefined
LFO 2 Destination	24	Undefined
LFO 2 Amount	25	Undefined
LFO 2 Clock Sync On/Off	86	
LFO 2 Keyboard Sync/Single Cycle	87	
LFO 2 Mono mode On/Off	88	
LFO 2 Amount Invert On/Off	89	
LFO 2 Clock Sync Devisor	100	
<b>Modulation Envelope parameters:</b>		
Mod Env Attack	26	Undefined
Mod Env Attack Type	101	
Mod Env Decay/Release	27	Undefined
Mod Env Destination	28	Undefined
Mod Env Amount	29	Undefined
Mod Env Amount Invert On/Off	108	
Mod Env Decay/Release On/Off	109	
Mod Env Repeat On/Off	110	
<b>Oscillator 1 parameters:</b>		

<b>Nord Lead 3 Parameter</b>	<b>MIDI Controller #</b>	<b>MIDI Controller Name</b>
Osc 1 Waveform	30	Undefined
Osc 1 Sync On/Off	35	LSB for Controller 3
Osc 1 Shape	79	Sound Controller 10
Osc 1 Sync Detune	115	
Osc 1 Sync Noise Timbre	117	
Osc 1 FM Amount (in Dual Sine FM)	119	
<b>Oscillator 2 parameters:</b>		
Osc 2 Coarse Tuning	78	
Osc 2 Fine Tuning	33	
Osc 2 Waveform	31	
Osc 2 Keyboard Tracking On/Off	34	LSB for Controller 2
Osc 2 Shape	102	
Osc 2 Sync On/Off	103	
Osc 2 Partial On/Off	104	
Osc 2 Dual Sine Carrier (in Dual Sine)	95	
Osc 2 Dual Sine Modulator (in Dual Sine)	96	
Osc 2 Noise type (LP/BP/HP)	90	
Osc 2 Noise Frequency	97	
Osc 2 Sync Detune	116	
Osc 2 Sync Noise Timbre	118	
Osc 2 FM Amount (in Dual Sine FM)	93	
<b>Oscillator modulation/mix parameters</b>		
Oscillator Mix	8	Balance
Oscillator Modulation Amount	70	
Oscillator Modulation Type	105	
Oscillator Modulation Noise	106	
<b>Amplifier parameters:</b>		
Amplifier Envelope Attack	73	Sound Controller 4 (Attack)
Amplifier Envelope Attack Type	107	
Amplifier Envelope Decay	36	LSB for Controller 4
Amplifier Envelope Sustain	37	LSB for Controller 5

<b>Nord Lead 3 Parameter</b>	<b>MIDI Controller #</b>	<b>MIDI Controller Name</b>
Amplifier Envelope Release	72	Sound Controller 3 (Release)
Amplifier Level	71	
<b>Filter parameters:</b>		
Filter Envelope Attack	38	LSB for Controller 6
Filter Envelope Attack Type	63	
Filter Envelope Decay	39	LSB for Controller 7
Filter Envelope Sustain	40	LSB for Controller 8
Filter Envelope Release	41	LSB for Controller 9
Filter Envelope Amount	43	LSB for Controller 11
Filter Envelope Velocity	45	LSB for Controller 13
Filter Envelope Amount Invert On/Off	62	LSB for Controller 13
Filter Type	44	LSB for Controller 12
Filter 1 Slope	58	
Filter Frequency1	74	Sound Controller 2 (Timbre)
Filter Resonance	42	LSB for Controller 10
Filter Frequency2 (in Multi Mode)	59	
Filter Keyboard Tracking On/Off	46	LSB for Controller 14
Filter Oscillator Bypass On/Off	60	
Filter 2 Envelope Control (in Multi Mode)	61	
Filter 1 Distortion (in Dist LP only)	114	

**In addition to the above, following controllers are used:**

- Panning is received as Controller 10. It's not transmitted from the Nord Lead 3.
- Amplifier Level responds to both Controller 71 and Controller 7. Only Controller 71 is transmitted from the Nord Lead 3.
- If the Expression Pedal input is used with an expression pedal, this is transmitted and received as Controller 11.
- If the Sustain Pedal input is used for sustain, this is transmitted as Controller 64 (Damper Pedal)
- Bank Select messages are transmitted and received as Controller 32.

## SYSTEM EXCLUSIVE IMPLEMENTATION

Numbers are in decimal except when preceded by a “\$” character, in which case they are in hexadecimal format.

### GENERAL MESSAGE FORMAT

Byte (Hex)	Description
\$F0	System Exclusive
\$33	Manufacturer ID (Clavia)
<Device ID>	selected Device ID for the specific instrument, 1-127, All
\$09	Model ID for Nord Lead 3
<Message Specification>	See each type of message, below.
<Data 1>	This and following bytes depend on the Message Type and Message Specification. Some messages have no data bytes at all.
<Data 2>	
<Data 3>	
<etc.>	
\$F7	End Of System Exclusive

### PROGRAM DUMPS

This message contains the actual Program (single sound) Dump. One complete message contains the data for one Program. It is transmitted from Nord Lead 3 in one of two cases:

- When a Program Dump is initiated from the front panel (the ‘Dump One’ command).
- When a valid Patch Dump Request message is received over MIDI.

The Message Type and Message Specification bytes in the SysEx message contains information about from which location (Slot or memory location) the Program Dump was sent. When a Program or Program Bank is sent back to Nord Lead 3, it will end up in this location.

- If the SysEx data for a complete Program Bank is sent (using the “Bank Dump” command), information about the location of each Program within the Bank is sent.  
When any or all of these Programs are sent back to Nord Lead 3, they will be stored in their original memory locations, but in the Bank that is currently selected in Nord Lead 3 when in Program Bank Receive mode (see “[Program Bank Receive](#)” on page 126).
- If the SysEx data for a single Program is sent using the “Dump One” command described on [page 122](#), it is being sent from the Slot and not from its original memory location.  
This means that when the Program is sent back to Nord Lead 3, it will not be stored, but placed in the original Slot. You will then have to manually save the Program to a memory location.

- If the SysEx data for a single Program is sent after receiving a Patch Dump Request message, either a Program in a specified memory location or in the Slot will be sent, depending on the Message Type byte in the Patch Dump Request message. This will also determine where the Patch will be placed when it is sent back to a Nord Lead 3.

**Note!** If the Program is requested from a Slot, sending the Program back will place it in that Slot again. If the Program is requested from a memory location, it will be sent back and stored to its original memory location when in Program Bank Receive mode (see [“Program Bank Receive” on page 126](#)).

#### PROGRAM DUMP TO/FROM SLOT (MESSAGE TYPE \$20)

Byte (Hex)	Description
\$F0	System Exclusive
\$33	Manufacturer ID (Clavia)
<Device ID> \$00-\$7F	selected Device ID for the specific instrument, 1-127, All
\$09	Model ID for Nord Lead 3
\$20	Message Type specifies dump source. \$20 = from Slot
\$00 to \$04	Specifies the source Slot: \$00-\$03 = Slot A-D. \$04 = Active Slot.
\$00	Spare. Always set to \$00
<Program Name>	Program Name. Max 16 characters long. Zero terminated if less than 16 characters.
\$00 (x 16)	16 spare Bytes for future expansion. Always set to \$00.
<Version MSB>	Most significant 7 bits of version number.
<Version LSB>	Least significant 7 bits of version number.
<Patch Data 1>	See <a href="#">page 156</a> .
<Patch Data 2>	
<Patch Data 3>	
:	
<Patch Data 210>	
\$F7	End Of System Exclusive

**PROGRAM DUMP TO/FROM MEMORY LOCATION (MESSAGE TYPE \$21)**

Byte (Hex)	Description
\$F0	System Exclusive
\$33	Manufacturer ID (Clavia)
<Device ID> \$00-\$7F	selected Device ID for the specific instrument, 1-127, All
\$09	Model ID for Nord Lead 3
\$21	Message Type specifies dump source. \$21= from memory location
\$00-\$07	Specifies the source Bank 0-8
\$00 to \$7F	Message Specification specifies the source memory location 1-128
<Program Name>	Program Name. Max 16 characters long. Zero terminated if less than 16 characters.
\$00 (x 16)	16 spare Bytes for future expansion. Always set to \$00.
<Version MSB>	Most significant 7 bits of version number.
<Version LSB>	Least significant 7 bits of version number.
<Patch Data 1>	See <a href="#">page 156</a> .
<Patch Data 2>	
<Patch Data 3>	
:	
<Patch Data 210>	
\$F7	End Of System Exclusive

**PATCH (PROGRAM) DUMP REQUEST**

This message should be used when requesting Nord Lead 3 to transmit one Program Dump. The Message Type and Message Specification are used to specify which Program should be transmitted.

This message is never transmitted from Nord Lead 3.

**PATCH DUMP REQUEST FROM SLOT (MESSAGE TYPE \$30)**

When the Patch Request message below is received by Nord Lead 3, it will reply by sending a Patch Dump of Message Type \$20 (from Slot). See [page 148](#).

Byte (Hex)	Description
\$F0	System Exclusive
\$33	Manufacturer ID (Clavia)
<Device ID> \$00-\$7F	selected Device ID for the specific instrument, 1-127, All
\$09	Model ID for Nord Lead 3
\$30	Message Type specifies dump request source. \$30 = from Slot
\$00-\$04	Message Specification specifies the requested Slot: \$00-\$03 = Slot A-D. \$04 = Active Slot.
\$00	Spare. Always set to \$00
\$F7	End Of System Exclusive

**PATCH DUMP REQUEST FROM MEMORY LOCATION (MESSAGE TYPE \$31)**

When the Patch Request message below is received by Nord Lead 3, it will reply by sending a Patch Dump of Message Type \$21 (from memory location). See [page 149](#).

Byte (Hex)	Description
\$F0	System Exclusive
\$33	Manufacturer ID (Clavia)
<Device ID> \$00-\$7F	selected Device ID for the specific instrument, 1-127, All
\$09	Model ID for Nord Lead 3
\$31	Message Type specifies dump request source. \$31= from memory location
\$00-\$07	Message Specification specifies the requested Bank (1-8)
\$00-\$7F	Message Specification specifies the requested memory location (1-128)
\$F7	End Of System Exclusive



## PERFORMANCE DUMP

This message contains the actual Performance. One complete message contains the data for one Performance. This message is transmitted from Nord Lead 3 in one of two cases:

- When a Performance Dump is initiated from the front panel.
- When a valid Performance Dump Request message has been received over MIDI.

The Message Type and Message Specification bytes in the SysEx message contains information about from which location (Slot or memory location) the Performance Dump was sent. When a Performance or Performance Bank is sent back to Nord Lead 3, it will end up in this location.

- If the SysEx data for a complete Performance Bank is sent (using the “Bank Dump” command), information about the location of each Performance within the Bank is sent.

**When any or all of these Performances are sent back to Nord Lead 3, they will be stored in their original memory locations when in Performance Bank Receive mode (see “Performance Bank Receive” on page 127).**

- If the SysEx data for a single Performance is sent using the “Dump One” command, it is being sent from the Slots and not from its original memory location.

**This means that when the Performance is sent back to Nord Lead 3, it will not be stored, but placed in the Slots. You will then have to manually save the Performance to a memory location.**

- If the SysEx data for a single Performance is sent after receiving a Performance Dump Request message, either a Performance in a specified memory location or in the Slots will be sent, depending on the Message Type byte in the Performance Dump Request message. This will also determine where the Performance will be placed when it is sent back to a Nord Lead 3.

**Note! If the Performance is requested from the Slots, sending the Performance back will place it in the Slots again. If the Performance is requested from a memory location, sending the Performance back will place it to its original memory location when in Performance Bank Receive mode (see “Performance Bank Receive” on page 127).**

**PERFORMANCE DUMP TO/FROM SLOT (MESSAGE TYPE \$28)**

<b>Byte (Hex)</b>	<b>Description</b>
\$F0	System Exclusive
\$33	Manufacturer ID (Clavia)
<Device ID> \$00-\$7F	selected Device ID for the specific instrument, 1-127, All
\$09	Model ID for Nord Lead 3
\$28	Message Type specifies dump source. \$28= from Slot
\$00	Spare1. Always set to \$00
\$00	Spare2. Always set to \$00
<Performance Name>	Program Name. Max 16 characters long. Zero terminated if less than 16 characters.
\$00 (x 16)	16 spare Bytes for future expansion. Always set to \$00.
<Version MSB>	Most significant 7 bits of version number.
<Version LSB>	Least significant 7 bits of version number.
<Performance Data 1>	See <a href="#">page 159</a> .
<Performance Data 2>	
<Performance Data 3>	
:	
<Performance Data 944>	
\$F7	End Of System Exclusive

**PERFORMANCE DUMP TO/FROM MEMORY LOCATION (MESSAGE TYPE \$29)**

Byte (Hex)	Description
\$F0	System Exclusive
\$33	Manufacturer ID (Clavia)
<Device ID> \$00-\$7F	selected Device ID for the specific instrument, 1-127, All
\$09	Model ID for Nord Lead 3
\$29	Message Type specifies dump source. \$29 = from memory location
\$00-\$01	Specifies the source Bank (1-2)
\$00 to \$7F	Specifies the source memory location (1-128)
<Performance Name>	Performance Name. Max 16 characters long. Zero terminated if less than 16 characters.
\$00 (x 16)	16 spare Bytes for future expansion. Always set to \$00.
<Version MSB>	Most significant 7 bits of version number.
<Version LSB>	Least significant 7 bits of version number.
<Performance Data 1>	See <a href="#">page 159</a> .
<Performance Data 2>	
<Performance Data 3>	
:	
<Performance Data 944>	
\$F7	End Of System Exclusive

## PERFORMANCE DUMP REQUEST

This message is used for requesting Nord Lead 3 to transmit one Performance Dump Message. The Message Type and Message Specification are used to specify which Performance should be transmitted. This message is never transmitted from the Nord Lead 3

### PERFORMANCE DUMP REQUEST FROM SLOT (MESSAGE TYPE \$38)

When the Performance Dump Request message below is received by Nord Lead 3, it will reply by sending a Performance Dump of Message Type \$28 (from Slots). See [page 152](#).

Byte (Hex)	Description
\$F0	System Exclusive
\$33	Manufacturer ID (Clavia)
<Device ID> \$00-\$7F	selected Device ID for the specific instrument, 1-127, All
\$09	Model ID for Nord Lead 3
\$38	Message Type specifies dump request source. \$38 = from Slot
\$00	Spare1. Always set to \$00
\$00	Spare2. Always set to \$00
\$F7	End Of System Exclusive

### PERFORMANCE DUMP REQUEST FROM MEMORY LOCATION (MESSAGE TYPE \$39)

When the Performance Dump Request message below is received by Nord Lead 3, it will reply by sending a Performance Dump of Message Type \$29 (from memory location). See [page 153](#)

Byte (Hex)	Description
\$F0	System Exclusive
\$33	Manufacturer ID (Clavia)
<Device ID> \$00-\$7F	selected Device ID for the specific instrument, 1-127, All
\$09	Model ID for Nord Lead 3
\$39	Message Type specifies dump request source. \$39 = from memory location
\$00-\$01	Specifies the requested Bank (1-2)
\$00-\$7F	Specifies the requested memory location (1-128)
\$F7	End Of System Exclusive

### ALL CONTROLLERS REQUEST (MESSAGE TYPE \$40)

This message instructs Nord Lead 3 to send all current MIDI Controller values for a specified Slot. This message can also be transmitted from the Nord Lead 3 by using the ‘Send MIDI Controllers’ function described on [page 121](#).

Byte (Hex)	Description
\$F0	System Exclusive
\$33	Manufacturer ID (Clavia)
<Device ID> \$00-\$7F	selected Device ID for the specific instrument, 1-127, All
\$09	Model ID for Nord Lead 3
\$40	Message Type specifies All Controllers Request.
\$00-\$04	Specifies the requested Slot: \$00-\$03 = Slot A-D. \$04 = Active Slot.
\$F7	End Of System Exclusive

### PROGRAM AND PERFORMANCE DATA FORMATS

In the Program and Performance Dump Messages, the Data Bytes contain the actual Program/Performance settings.

- The patch data is viewed as a bit stream where the different parameters only use as many bits as necessary for their actual format. All parameters are oriented with the most significant bit first. An 8-bit checksum is calculated over the entire data block and stored as the last 8 bits of the file. The checksum is calculated by adding all data Bytes together. Since a MIDI SysEx data Byte can only contain 7 bits, the bit stream is 8 to 7 bit converted to fit the MIDI format.
- A complete Patch (Program) Dump, including SysEx header and data, is transmitted in 261 Bytes. See the “Program Dump Format” table, below.
- A complete Performance Dump, including SysEx header and data, is transmitted in 1024 Bytes. See the “Performance Data Format” table, on [page 159](#).

**PATCH (PROGRAM) DUMP FORMAT**

<i>Size (bits)</i>	<i>Name</i>	<i>Min</i>	<i>Max</i>	<i>Comment</i>
16	version_number			Decimal OS version number (# x 100)
7	osc1_shape	0	127	
7	osc2_coarse_pitch	0	127	
7	osc2_fine_pitch	0	127	
7	osc2_shape	0	127	
7	oscmix	0	127	
7	oscmid	0	127	
7	lfo1_rate	0	127	
7	lfo1_amount	0	127	
7	lfo2_rate	0	127	
7	lfo2_amount	0	127	
7	amp_env_attack	0	127	
7	amp_env_decay	0	127	
7	amp_env_sustain	0	127	
7	amp_env_release	0	127	
7	output_level	0	127	
7	filt_env_attack	0	127	
7	filt_env_decay	0	127	
7	filt_env_sustain	0	127	
7	filt_env_release	0	127	
7	mod_env_attack	0	127	
7	mod_env_decay/release	0	127	
7	mod_env_amount	0	127	
7	filt_env_amount	0	127	
7	filt_frequency1	0	127	
7	filt_resonance	0	127	
7	filt_frequency2	0	127	
7	unison_amount	0	127	
7	filt_dist_amount	0	127	
7	osc1_sync_tune	0	127	
7	osc2_sync_tune	0	127	
7	osc1_noise_seed	0	127	
7	osc2_noise_seed	0	127	
7	osc1_modulator_amount	0	127	In Dual Sine mode
7	osc2_modulator_amount	0	127	In Dual Sine mode
7	osc2_carrier_pitch	0	127	In Dual Sine mode
7	osc2_noise_type	0	127	LP/BP/HP
7	osc2_modulator_pitch	0	127	In Dual Sine mode
7	osc2_noise_frequency	0	127	
8	spare1	0	255	
8	spare2	0	255	
7	glide_rate	0	127	
7	arpeggio_rate	0	127	
7	vibrato_rate	0	127	
7	vibrato_amount	0	127	
7	arpeggio_sync_divisor	0	127	
7	lfo1_sync_divisor	0	127	
7	lfo2_sync_divisor	0	127	
7	transpose	0	127	
8	spare3	0	255	
8	spare4	0	255	
3	osc1_waveform	0	5	
1	osc1_sync	0	1	
3	osc2_waveform	0	5	
1	osc2_sync	0	1	

<i>Size (bits)</i>	<i>Name</i>	<i>Min</i>	<i>Max</i>	<i>Comment</i>
1	osc2_kbt	0	1	Off or On
1	osc2_partial	0	1	Off or On
3	oscmid_type	0	5	
3	lfo1_waveform	0	5	
4	lfo1_destination	0	11	
2	lfo1_env/kbs	0	2	
1	lfo1_mono	0	1	Off or On
1	lfo1_invert	0	1	Off or On
3	lfo2_waveform	0	5	
4	lfo2_destination	0	11	
2	lfo2_env/kbs	0	2	
1	lfo2_mono	0	1	Off or On
1	lfo2_invert	0	1	Off or On
1	mod_env_invert	0	1	Off or On
4	mod_env_destination	0	11	
1	mod_env_decay/release	0	1	Selects Decay or Release mode
1	mod_env_repeat	0	1	Off or On
3	filt1_type	0	5	
2	filt1_slope	0	2	
1	filt1_env_velocity	0	1	Off or On
1	filt1_kbt	0	1	Off or On
1	filt1_env_invert	0	1	Off or On
1	amp_env_exp_attack	0	1	Off or On
1	mod_env_exp_attack	0	1	Off or On
1	filt1_env_exp_attack	0	1	Off or On
1	filt1_mode	0	1	Selects Single or Dual Filter mode
1	filt2_env	0	1	Selects if Filt2 is controlled by Filt_Env
3	filt2_type	0	5	
1	filt_bypass	0	1	Off or On
1	lfo1_clocksync	0	1	Off or On
1	lfo2_clocksync	0	1	Off or On
1	arpeggiator_clocksync	0	1	Off or On
1	oscmix_noise	0	1	Off or On
2	glide_mode	0	2	Off, On or Auto
2	vibrato_source	0	2	Off, Wheel or Aftertouch
1	mono_mode	0	1	Off or On
1	arpeggio_run	0	1	Off or On
8	spare5	0	255	
1	unison_mode	0	1	Off or On
3	octave_shift	0	4	
1	chord_mem_mode	0	1	Off or On
3	arpeggio_mode	0	3	Up, Down, Up/down or Random
3	arpeggio_range	0	3	
1	arpeggio_kbd_sync	0	1	Off or On
8	spare6	0	255	
1	spare7	0	1	Off or On
1	legato_mode	0	1	Off or On
2	mono_allocation_mode	0	2	Off, Hi or Lo
208	wheel_morph_params	0	127	See 'Morph parameter list' below
208	a.touch_morph_params	0	127	See 'Morph parameter list' below
208	velocity_morph_params	0	127	See 'Morph parameter list' below
208	kbd_morph_params	0	127	See 'Morph parameter list' below
5	chord_mem_count	0	23	2-24
8	chord_mem_position	0	255	2-24
8	spare8	0	255	
8	checksum	0	255	

**MORPH GROUP PARAMETER LIST**

This list shows the parameters sent for each of the four Morph groups:

<i>Size (bits)</i>	<i>Name</i>	<i>Min</i>	<i>Max</i>	<i>Comment</i>
8	lfo1_rate	-128	127	
8	lfo1_amount	-128	127	
8	lfo2_rate	-128	127	
8	lfo2_amount	-128	127	
8	mod_env_attack	-128	127	
8	mod_env_decay/release	-128	127	
8	mod_env_amount	-128	127	
8	osc2_fine_pitch	-128	127	
8	osc2_coarse_pitch	-128	127	
8	oscmid	-128	127	
8	oscmix	-128	127	
8	osc1_shape	-128	127	
8	osc2_shape	-128	127	
8	amp_env_attack	-128	127	
8	amp_env_decay	-128	127	
8	amp_env_sustain	-128	127	
8	amp_env_release	-128	127	
8	filt_env_attack	-128	127	
8	filt_env_decay	-128	127	
8	filt_env_sustain	-128	127	
8	filt_env_release	-128	127	
8	filt_env_amount	-128	127	
8	filt_frequency1	-128	127	
8	filt_frequency2	-128	127	
8	filt_resonance	-128	127	
8	output_level	-128	127	



**PERFORMANCE DATA FORMAT**

<i>Size (bits)</i>	<i>Name</i>	<i>Min</i>	<i>Max</i>	<i>Comment</i>
16	version_number			Decimal OS version number (# x 100)
8	enabled_slots	0	15	
8	focused_slot	0	3	
8	midi_channel_slot_a	0	16	0 = Off
8	midi_channel_slot_b	0	16	0 = Off
8	midi_channel_slot_c	0	16	0 = Off
8	midi_channel_slot_d	0	16	0 = Off
8	audio_channel_slot_a	0	5	
8	audio_channel_slot_b	0	5	
8	audio_channel_slot_c	0	5	
8	audio_channel_slot_d	0	5	
8	splitpoint_key	0	127	
8	splitpoint	0	1	Off or On
8	sustain_enable	0	15	
8	pitchbend_enable	0	15	
8	modwheel_enable	0	15	
8	bank_slot_a	0	7	
8	program_slot_a	0	127	
8	bank_slot_b	0	7	
8	program_slot_b	0	127	
8	bank_slot_c	0	7	
8	program_slot_c	0	127	
3	bank_slot_d	0	7	
8	program_slot_d	0	127	
8	morph3_source_select	0	1	Control pedal or aftertouch
8	midi_clock_keysync	0	1	Off or On
8	keyboard_hold	0	1	Off or On
8	spare3			Always set to zero
8	spare4			Always set to zero
8	spare5			Always set to zero
8	spare6			Always set to zero
8	spare7			Always set to zero
8	spare8			Always set to zero
8	spare9			Always set to zero
8	spare10			Always set to zero
8	spare11			Always set to zero
8	spare12			Always set to zero
16	midi_clock_rate	0	210	
8	bend_range_up	0	24	
8	bend_range_down	0	24	
7x16	patchname_slot_a			Max 16 characters long
7x16	patchname_slot_b			Max 16 characters long
7x16	patchname_slot_c			Max 16 characters long
7x16	patchname_slot_d			Max 16 characters long
8	patch_data [A,B,C,D]			See <a href="#">"Patch (Program) dump format"</a> on page 156
8	checksum	0	255	

# MIDI IMPLEMENTATION CHART

Model: Clavia Nord Lead 3

Date: 2001-04-01

Function		Transmitted	Recognized	Remarks
Basic Channel	Default Channel	1 – 16 1 – 16	1 – 16 1 – 16	
Mode	Default Messages Altered	Mode 3 X *****	Mode 3 X	
Note Number	True Voice	0 – 127 *****	0 – 127 0 – 127	
Velocity	Note ON Note OFF	O v = 1 – 127 O	O v = 1 – 127 O	
Aftertouch	Key Channel	X O	X O	
Pitch Bend		O	O	
Control Change		O	O	See the MIDI Implementation section.
Prog Change	True #	O 0 – 127	O 0 – 127	
System Exclusive		O	O	See the MIDI Implementation section.
System	: Song Pos	X	O	When using external sync of Arpeggiator and LFOs
Common	: Song Sel	X	X	
	: Tune	X	X	
System	: Clock	O	O	
Real Time	: Commands	X	X	
Aux	: Local ON/OFF	X	X	
Mes-	: All Notes Off	X	X	
sages	: Active Sense	X	X	
	: Reset	X	X	
Notes				

Mode 1: OMNI ON, POLY  
Mode 3: OMNI OFF, POLY

Mode 2: OMNI ON, MONO  
Mode 4: OMNI OFF, MONO

O: Yes  
X: No

# INDEX

## NUMERICS

---

12 dB (Filter) 85  
 24 dB (Filter) 85  
 6 dB (Filter) 85

## A

---

Acoustic (sound category) 24  
 Active Device 116  
 ADSR envelope  
   Amplifier 78  
   behavior 80  
   Filter 82  
 Advanced Subtractive Synthesis 11  
 aftertouch  
   MIDI transmission and reception 138  
   Morph 29  
 Amplifier 78  
   attack 79  
   decay 79  
   release 80  
   sustain 80  
 arpeggio 97  
   hold 104  
   mask 100, 131  
   modes 130  
   ranges 130  
   rate 97  
   run 98  
   sub 98, 130  
   synching to MIDI/Master Clock 102  
 Arpeggio (sound category) 24  
 attack  
   Amplifier Envelope 79  
   Filter Envelope 83  
   Modulation Envelope 49  
 audio routing (to physical outputs) 125

## B

---

band reject (Filter 1) 88  
 bandpass (Filter 1) 87  
 Bank Select (MIDI) 139

Bass (sound category) 24  
 bend (set pitch bend range) 123  
 BP (Filter 1) 87  
 BR (Filter 1) 88  
 buttons  
   using 22

## C

---

carrier (FM) 59, 66, 72  
 categories (sound) 24  
 Chord Memory 112  
 Classic (sound category) 24  
 Classic Lowpass (Filter 1) 88  
 Coarse Tune (Oscillator 2) 67  
 connections  
   audio 10  
   MIDI 10, 139  
   pedals 10  
 control pedal  
   connecting 10  
   Morph 29  
   technical requirements 10  
   using 20  
   using for controlling a Morph group 31  
 controllers  
   list (MIDI) 143  
   MIDI transmission and reception 121, 138  
   request 155  
 copy  
   Morph groups 31, 133  
   parameters 133  
   Programs 27  
     from a memory location to another 27  
     from a Slot to another 28, 133  
 cutoff frequency  
   Filter 1 85  
   Filter 2 90

## D

---

decay  
   Amplifier Envelope 79  
   Filter Envelope 83  
   Modulation Envelope 49  
 Del (delete letter position) 26, 36  
 delete  
   Morph groups 31  
   Performances 40, 127  
   Programs 28, 126

- DFM (Oscillator Modulation) 72
  - Display 9
    - special info when editing parameters 135
  - DIST (Oscillator Modulation) 71
  - DIST LP (Filter 1) 89
  - distortion
    - Filter 1 89
    - Oscillator Modulation 71
  - Distortion Modulation (Oscillator Modulation) 70
  - DM 70
  - download
    - Performances from MIDI 41
    - Programs from MIDI 28
  - Drum (sound category) 24
  - Dump One 122
- E**
- 
- edit
    - Morph groups 29
    - Performances 33
    - Programs 21
  - encoders 21
  - EnvAmt (Filter) 83
  - envelope
    - Amplifier 78
    - Filter 82
      - controlling Filter 2 96
    - Modulation Envelope 49
  - erase
    - Morph groups 31
    - Performances 40, 127
    - Programs 28, 126
  - expression pedal
    - connecting 10
    - Morph 29
    - technical requirements 10
    - using 20
    - using for controlling a Morph group 31
- F**
- 
- factory presets 137
    - restoring 137
  - Fantasy (sound category) 24
  - FILT (Oscillator Modulation) 71
  - Filt.Env (Filter) 96
  - Filter
    - band reject (BR) 88
    - bandpass (BP) 87
    - Classic Lowpass (CLASSIC) 88
    - Dist LP 89
    - envelope 82
      - attack 83
      - controlling Filter 2 96
      - decay 83
      - invert (amount) 83
      - release 83
      - sustain 83
      - velocity control 83
    - highpass (HP) 87
    - KBT (Keyboard Tracking) 89
    - keyboard tracking
      - customize 136
    - lowpass (LP) 87
    - Multi Filter Modes 90
    - Multi Notch 96
    - Multi Peak 95
    - Osc 2 Bypass 96
    - overview 82
    - resonance 85
    - roll-off 85
    - Single Filter Modes 84
    - slope 85
    - types
      - Multi 91
      - Single 87
  - Filter FM (Oscillator Modulation) 71
  - Fine Tune (Oscillator 2) 67
  - Flash memory 137
  - FM
    - Filter 71
    - Oscillator 1 59
    - Oscillator 2 65
    - Oscillator Modulation 72
      - different combinations 74
  - FM Init 22, 129
  - Freq2/Dist (Filter) 90
  - frequency
    - Filter 1 85
    - Filter 2 90
    - modulation (FM) 72
    - Vibrato 131
  - Frequency1 (Filter) 85
  - front panel 8
  - FX (sound category) 24

**G**

glide (portamento) 106  
     mode 106  
     polyphonic 108  
     rate 106  
 Global (Octave Shift) 112

**H**

highest note priority (Hi) 107  
 highpass (Filter 1) 87  
 HP (Filter 1) 87

**I**

Ins (insert letter position) 26, 37  
 internal memory 137  
 Internet 7

**K**

KB Hold 114  
     enabling/disabling 116  
 KB Split 15, 34, 110  
 KBT  
     Filter 89  
     Oscillator 2 66, 69  
 keyboard  
     aftertouch Morph 29  
     Hold 114  
         enabling/disabling 116  
     range Morph 29  
     split 15, 34, 110  
         setting the split point 15, 111  
         with layers 16  
     velocity  
         Filter Envelope 83  
         Morph 29  
 Keyboard Tracking  
     customize 136  
     Filter 89  
     Oscillator 2 66, 69  
 knobs  
     using 21

**L**

layer 14  
     with keyboard split 16  
 Lead (sound category) 24

LED display (Oscillator 2) 67  
 LED graphs  
     using 21  
 legato  
     monophonic 107  
     polyphonic 108  
 level  
     individual for each Slot 81  
     master 8  
 LFO 42  
     amount 46  
     destinations 45  
     Env/KB sync 46  
     invert amount 46  
     modulation table 48  
     mono mode 46  
     rate 42  
         sync to MIDI/Master Clock 43  
     waveforms 44  
 load  
     Programs 26  
 lowest note priority (Lo) 107  
 lowpass (Filter 1) 87  
 LP (Filter 1) 87

**M**

mask (arpeggio) 100, 131  
 Master Clock 117  
     keyboard sync 118  
     source 117  
 Master Level 8  
 Master Tune 123  
     adjusting 19  
 memory (internal) 137  
 memory protect (enabling/disabling) 129  
 MIDI  
     about the implementation 138  
     Bank Select 139  
         recording in sequencer 140  
     basic settings 12  
     channel  
         Global 120  
         Slot 119  
     channels  
         using with sequencer 140  
     Clock 141  
     connections 139  
     controllers  
         "chasing" when using a sequencer 141

- list 143
    - recording in sequencer 140
  - Dump One (Program or Performance) 122
  - implementation chart 160
  - local on/off 120, 139
  - menu 119
  - Program Change 139
    - recording in sequencer 140
  - send all MIDI controllers 121
  - send/receive program change and controllers 121
  - Song Position Pointer 141
  - sync to MIDI Clock 117
  - SysEx
    - external All Controllers request 155
    - general message format 147
    - implementation 147
    - Morph group parameter list 158
    - Performance dump 151
      - format 159
      - from memory location 153
      - from Slot 152
    - Performance dump request 154
      - from memory location 154
      - from Slot 154
    - Program and Performance data formats 155
    - Program dump 147
      - format 156
      - from memory location 149
      - from Slot 148
    - Program dump request 150
      - from memory location 150
      - from Slot 150
    - SysEx dump of Performance Banks 127, 142
    - SysEx dump of Program Banks 125, 142
    - SysEx dump of single Performances 141
    - SysEx dump of single Programs 141
    - SysEx ID 122
    - SysEx reception of Performance Banks 127, 142
    - SysEx reception of Program Banks 126, 142
  - Modulation Envelope 49
    - amount 51
    - attack 49
    - decay/release 49
    - destinations 50
    - invert (amount) 51
    - modulation table 52
    - Repeat mode 52
  - Modulation Wheel 19, 116
    - enabling/disabling 116
    - Morph 29
  - modulator (FM) 59, 66, 72
  - Monitor/Copy 133
  - mono (Voice Mode) 107
  - monophonic operation 107
  - Morph groups 29
    - assigning parameters 29
    - control/expression pedal 29
    - controlling clock-synched parameters 31
    - copy and paste 31, 133
    - deassigning parameters 31
    - deleting 31
    - keyboard aftertouch 29
    - Keyboard Morph 136
    - keyboard range 29
    - keyboard velocity 29
    - selecting source for Morph group 3 124
  - Mute (parameter sections) 23, 134
- 
- ## N
- 
- Navigator buttons 9
  - noise
    - Osc Mix (noise3) 77
    - Oscillator 1 56
    - Oscillator 2 63
  - notch (Filter 1) 88
  - Note On/Off
    - MIDI transmission and reception 138
  - Note Trig (Nord Rack 3) 13, 112
- 
- ## O
- 
- Octave Shift 111
    - global for keyboard and MIDI 112
    - local for Slot 111
  - Organ (sound category) 24
  - OS upgrades 137
  - Osc Mix 77
  - Osc Mod 70
  - Osc2/Byp/Noise3 (Filter) 96
  - Oscillator
    - Bypass (Filter) 96
    - Mixer 77
    - Modulation 70
    - shape control 53, 63
    - sync 60

- waveforms 53, 63
  - Dual Sine (Oscillator 1) 57
  - Dual Sine (Oscillator 2) 64
  - Dual Sine FM (Oscillator 1) 59
  - Dual Sine FM (Oscillator 2) 65
  - noise (Oscillator 1) 56
  - noise (Oscillator 2) 63
  - noise3 (Oscillator Mixer) 77
  - pulse and square wave 54
  - sawtooth wave 53
  - sine wave 55
  - synched noise 56
  - triangle wave 54
- Oscillator 1 & 2 53
- Oscillator 2 63
- output
  - level
    - individual 81
    - master 8
  - physical 10
  - routing 125

---

**P**

- Pad (sound category) 25
- panic 20, 115
- parallel filters 91, 92, 94
- Partial No. (Oscillator 2) 67, 68
- paste
  - Morph groups 133
  - parameters 133
  - Programs 133
- pdf file (reading the manual as...) 7
- pedals
  - connecting 10
  - control/expression 20
  - sustain 20
- Performance 32
  - creating and editing 33
  - deleting 40, 127
  - download from MIDI 41
  - exit Performance mode 40
  - getting started 17
  - naming 36
  - recalling 32
  - selecting Programs 33
  - solo single sounds 33
  - store 36
  - stored parameters 41
- phaser 95, 96

- Piano (sound category) 25
- pitch
  - bend range 115
  - LED Display (Oscillator 2) 67
  - master 123
  - Oscillator 2 67
- Pitch Stick 18, 115
  - enabling/disabling 116
  - MIDI transmission and reception 138
  - set bend range 115, 123
- portamento (Glide) 106
  - mode 106
  - polyphonic 108
  - rate 106
- Program
  - categories 24
  - copying 27
    - from a Slot to another 28
  - deleting 28, 126
  - downloading from MIDI 28
  - editing 21
  - extracting from a Performance 39
  - layering 14
  - loading 26
  - naming 24, 132
  - reverting 22
  - searching 26
  - selecting 13
  - selecting in a Performance 33
  - solo in a Performance 33
  - sorting 24, 26, 132
  - storing 23
- Program Change (MIDI) 139

---

**Q**

- Q-value (Filter) 85

---

**R**

- Rate
  - Arpeggio 97
  - Glide 106
  - LFO 1 & 2 42
  - Master Clock 117
  - Vibrato 131
- rear panel 9
- release
  - Amplifier Envelope 80
  - Filter Envelope 83

- Modulation Envelope 49
- Resonance (Filter) 85
- ring modulation (Oscillator Modulation) 75
- RM (Oscillator Modulation) 75
- roll-off (Filter 1) 85
- Rotary Dial 9
- rotary encoders 21

---

**S**

---

- save
  - Performances 36
  - Programs 23
  - system settings 128
- semitones (Oscillator 2) 67, 68
- sequencing with Nord Lead 3 139
- serial filters 93
- Set Split (keyboard split) 15, 111
- Shift button 9
- slope (Filter 1) 85
- Slot
  - activating 14
  - buttons 9
  - deactivating 14
  - selecting 13
  - solo 33
  - using 13
- Solo a Program (in a Performance) 33
- Song Position Pointer (MIDI) 141
- sort
  - Programs 24, 26, 132
- Sort Mode 26
- sound categories 24
- Sound Init 22, 132
- Sound menu 130
- split
  - keyboard 15, 110
  - setting the split point 15, 111
- Stack 113
  - Detune 114
- stereo output 125
- store
  - Performances 36
  - Programs 23
  - system settings 128
- sub arpeggio 98, 130
- sustain
  - Amplifier Envelope 80
  - Filter Envelope 83
- sustain pedal

- connecting 10
- enabling/disabling 116
- setting polarity 124
- settings 20
- sync
  - oscillator 60
  - to MIDI Clock/Master Clock 117
- Synth (sound category) 25
- Synth menu 123
- system settings
  - store 128

---

**T**

---

- tune (master) 19, 123

---

**U**

---

- Unison 109
- User (sound category) 25

---

**V**

---

- velocity
  - Filter Envelope 83
  - Morph 29
- vibrato 105
  - amount 105, 131
  - control source 105
  - frequency 131
- voice mode (Mono, Legato) 106