

nord lead 4
performance synthesizer

nord lead 4R
performance synthesizer

**User Manual
Nord Lead 4
Nord Lead 4R**

OS Version 1.3x



CAUTION: TO REDUCE THE RISK OF ELECTRIC SHOCK DO NOT REMOVE COVER (OR BACK). NO USER SERVICEABLE PARTS INSIDE. REFER SERVICING TO QUALIFIED PERSONNEL.

ATTENTION: POUR EVITER LES RISQUES DE CHOC ELECTRIQUE, NE PAS ENLEVER LE COUVERCLE. AUCUN ENTRETIEN DE PIECES INTERIEURES PAR L'USAGER. CONFIER L'ENTRETIEN AU PERSONNEL QUALIFE.

AVIS: POUR EVITER LES RISQUES D'INCIDENTE OU D'ELECTROCUTION, N'EXPOSEZ PAS CET ARTICLE A LA PLUIE OU L'HUMIDITET.



The lightning flash with the arrowhead symbol within an equilateral triangle is intended to alert the user to the presence of uninsulated voltage within the products enclosure that may be of sufficient magnitude to constitute a risk of electric shock to persons.

Le symbole éclair avec le point de flèche à l'intérieur d'un triangle équilatéral est utilisé pour alerter l'utilisateur de la présence à l'intérieur du coffret de "voltage dangereux" non isolé d'ampleur suffisante pour constituer un risque d'électrocution.



The exclamation mark within an equilateral triangle is intended to alert the user to the presence of important operating and maintenance (servicing) instructions in the literature accompanying the product.

Le point d'exclamation à l'intérieur d'un triangle équilatéral est employé pour alerter l'utilisateur de la présence d'instructions importantes pour le fonctionnement et l'entretien (service) dans le livret d'instructions accompagnant l'appareil.

Instructions pertaining to a risk of fire, electric shock or injury to persons.

IMPORTANT SAFETY INSTRUCTIONS SAVE THESE INSTRUCTIONS

Warning - When using electric products, basic precautions should always be followed, including the following:

- 1) Read these instructions.
- 2) Keep these instructions.
- 3) Heed all warnings.
- 4) Follow all instructions.
- 5) Do not use this apparatus near water.
- 6) Clean only with dry cloth.
- 7) Do not block any ventilation openings. Install in accordance with the manufacturer's instructions.
- 8) Do not install near any heat sources such as radiators, heat registers, stoves, or other apparatus (including amplifiers) that produce heat.
- 9) Do not defeat the safety purpose of the polarized or grounding-type plug. A polarized plug has two blades with one wider than the other. A grounding type plug has two blades and a third grounding prong. The wide blade or the third prong are provided for your safety. If the provided plug does not fit into your outlet, consult an electrician for replacement of the obsolete outlet.
- 10) Protect the power cord from being walked on or pinched particularly at plugs, convenience receptacles, and the point where they exit from the apparatus.
- 11) Only use attachments/accessories specified by the manufacturer.
- 12) Use only with the cart, stand, tripod, bracket, or table specified by the manufacturer, or sold with the apparatus. When a cart is used, use caution when moving the cart/apparatus combination to avoid injury from tip-over.
- 13) Unplug this apparatus during lightning storms or when unused for long periods of time.
- 14) Refer all servicing to qualified service personnel. Servicing is required when the apparatus has been damaged in any way, such as power-supply cord or plug is damaged, liquid has been spilled or objects have fallen into the apparatus, the apparatus has been exposed to rain or moisture, does not operate normally, or has been dropped.



Additional Safety Information

No naked flame sources, such as lighted candles, should be placed on the apparatus;

Do not use the apparatus in tropical climates.

WARNING: To reduce the risk of fire or electric shock, do not expose this apparatus to rain or moisture.

The apparatus shall not be exposed to dripping or splashing and that no objects filled with liquids, such as vases, shall be placed on the apparatus.

The mains plug is used as the disconnect device and shall remain readily operable.

Il convient de ne pas placer sur l'appareil de sources de flammes nues, telles que des bougies allumées;

L'appareil n'est pas destiné à être utilisé sous un climat tropical.

L'appareil ne doit pas être exposé à des égouttements d'eau ou des éclaboussures et de plus qu'aucun objet rempli de liquide tel que des vases ne doit être placé sur l'appareil.

Lorsque la prise du réseau d'alimentation est utilisée comme dispositif de déconnexion, ce dispositif doit demeurer aisément accessible.

Trademarks: The Nord logo is a trademark of Clavia DMI AB. All other trademarks mentioned in this publication are the properties of their respective holders.

Specifications and appearances are subject to change without notice.

Copyright © Clavia DMI AB



Intertek

Nord Lead 4 User Manual

1 Introduction

Thank you!	5
Features	5
Synthesizer	5
Continuous Morph	5
Impulse Morphs	5
Slots	5
Effects	5
Programs	5
Performances	5
Nord Sound Manager	5
2 models - keyboard and tabletop	5

2 Panel Overview

The Panel	6
Continuous Morph	6
Programs, Performances and Slots	6
Performance controls	6
Synth	6
Voice Mode	6
LFOs and Modulation Envelope	7
Oscillators	7
Filter	7
Effects	7
Knobs & dials	7
Knobs	7
Program Dial	7
Oscillator 1 Wavetable dial	7
Master Level	7
Buttons	8
On/Off buttons	8
Shift button	8
Selector buttons	8
Master Clock (Mst Clk)	8
Copy	8
Morph Lock	8
Paste	8

3 Getting Started

The Sounds	9
Selecting Programs	9
Editing Programs	9
Storing a Program	9
Slots	10
Selecting Performances	10
Editing a Performance	10
Layering two Programs	10
Creating a Split	10
Setting the Split	10
Storing a Performance	11
Shift Editing	11
Extracting a Program from a Performance	11
MIDI	11

4 Slots and Memory

General Overview	12
Slot Handling	12
Split	12
Solo	12
Multi Focus	12
Program Handling	13
Programs	13
Performances	13
Performance Mode	13
Loading	13
Storing	13
Copying Slots to a Performance	13
Copying a Performance to Program	13

5 Master Clock & Patterns

Master Clock	14
External Sync	14
Arpeggio with Mst Clk	14
Synced Delay repeats	15
Sync the LFO	15
Patterns	15
Selecting a Pattern	15
Examples	15
Across the Slots	15
Sound Menu Kbd Sync	15

6 Morph

Morphing	16
Continuous Morphs	16
Velocity	16
Wheel	16
Assign a Morph source to a parameter	17
Continuous Morph parameters	17
Impulse Morphs	17
Impulse Morph	17
Impulse Morph Protection	17
Impulse Morph Merge	17
Editing Morphs	18
Morph Lock Mode	18

7 Mutator

Mutator	19
Process and Strength	19
Process A	19
Process B	19
Random	19
Executing the Mutation	19
Undo a Mutation	19
Mutator Examples	20

8 Panel Reference

Master Level	21
MIDI LED	21
Continuous Morphs (Morph)	21
Clear Continuous Morphs	21
Program Dial	21
LED Display	22
Performance Mode	22
Execute	22
Store	22
Slot A - D buttons	22
System - MIDI - Sound - Mutator	22
Hold	22
Hold Enable	22
Chord Memory	22
Set Chord	22
Octave Shift	23
Global Octave Shift	23
Split	23
Master Clock (Mst Clk)	23
Tap/Set	23
Pattern	23
Copy	23
Morph Lock	23
Paste	23
Impulse Morph 1 - 7	23
Pitch Stick	24
Shift	24

Modulation Wheel	24
Voice Mode	24
Unison	24
Vibrato (Dly Vib, Whl)	24
Mono	24
Legato	24
Glide	24
Bend Range	24
Low Frequency Oscillators (LFO)	25
LFO 1	25
LFO 2	25
Rate	25
Waveform Selector	25
LFO Destination Selector	25
Amount	25
LFO Modulation Polarities	25
Master Clock (Mst Clk)	26
Arpeggio (Arp)	26
Keyboard Sync (KBS)	26
Impulse Morph Sync (Imp Sync)	26
Arpeggiator	26
Rate	26
Arpeggio Directions	26
Arpeggio Run	26
Arpeggio Range	26
Modulation Envelope	26
Attack	27
Decay/Release (Dec/Rel)	27
Destination selector	27
AR mode	27
Impulse Morph Sync (Imp Sync)	27
Amount	27
Oscillators	27
Oscillator 1	27
Sound Init	28
Oscillator 2	28
Fine tune - Noise Res	28
Semi Tones - Noise Freq	28
Oscillator Modulation (Osc Mod)	28
Frequency Modulation (FM)	28
Oscillator Sync (Sync)	28
Osc Mod Amount	29
Type	29
Panic	29
Oscillator mix	30
Osc Mix	30
Amp & Filter Envelopes	30
Attack	30
Decay	30
Sustain	31
Release	31
Filter	31
Filter Frequency (Freq)	31
Filter Resonance	32
Drive	32
Envelope Amount (Env Amt)	32
Keyboard Tracking (KB Track)	32
Filter Type	32
Low Pass 12, 24 & 48	32
Band Pass	32
High Pass	33
Ladder M	33
Ladder TB	33
Velocity	33
Amp Vel	33
Output	33
Level	33
FX	33
Crush	33
Compressor	33
Drive	33
Talk1, Talk2	33
Comb	33
Note Trig	34
Delay, Reverb	34
Delay	34
Tempo	34
Feedback	34
Dry/Wet	34
On/Off	34
Reverb	34
Dry/Wet	34
Reverb Select	34

9 Nord Sound Manager

System requirements	35
---------------------	----

10 Synthesis Basics

Introduction	36
The "building blocks"	36
Oscillators and waveforms	36
Filter	39
Amplifier	41
Envelopes	41
LFOs	42

11 The Menus

System Menu	43
1 - Memory Protect – On, Off	43
2 - Transpose	43
3 - Fine Tune	43
4 - Sustain Pedal Polarity	43
5 - Ctrl Pedal Type	43
6 - Ctrl Pedal Mode	43
7 - Ctrl Pedal Gain	43
8 - Impulse Morph Protect	43
A B C D - Slot Output Routing	43
MIDI Menu	44
G - Global Channel	44
A, B, C, D - Slot Channel	44
t - Soft Thru Channel	44
1 - MIDI Interface	44
2 - Local Control	44
3 - Control Change (CC) Mode	44
4 - Program Change Mode	44
5 - Pitch Bend Mode	44
6 - Send CC	44
7 - Dump One	44
8 - Dump Program Bank	44
Sound Menu	45
1 - Mst Clk Kbd Sync	45
2 - Delay Mode	45
3 - Vibrato Rate	45
4 - Vibrato Amount	45
5 - Impulse Morph Merge	45
Mutator	45

12 MIDI

Nord Lead 4 MIDI operation	46
MIDI Settings	46
Global MIDI Channel	46
Slot MIDI Channels	46
Sequencing: Global MIDI Channel	46
Recording parameter changes	46
Sequencing: Slot MIDI Channels	46
Control Slots with another keyboard	47
Message types	47
Program Changes and Bank Select	47
Control Change messages	47
Pedal Control Change	47
Volume	47
Pan CC	47
MIDI Local	47
MIDI Thru	47
MIDI Clock	47
USB MIDI	47
Panic	47
MIDI Dumps	47
Transmit settings	47
Receive Programs or Banks	47
MIDI Controller list	48
MIDI Implementation Chart	49

13 Appendix

Specifications	50
Audio Connections	51
Headphones	51
1, 2, 3 & 4 Outputs	51
MIDI Connections	51
MIDI OUT	51
MIDI IN	51
USB Connection	51
USB MIDI	51
Pedal Connections	51
Sustain pedal	51
Control pedal	51
Display Messages	52

14 Index

1 Introduction

Thank you!

First we would like to thank you for purchasing the Nord Lead 4. The Nord Lead 4 is built on Clavia's legacy of making virtual analog synthesizers for almost 20 years and we hope you will have as much fun owning the instrument as we had developing it.

To us, details are everything - and an intuitive user interface is just as important as the actual sound. We are musicians ourselves, and know by experience how frustrating it can be to have to wade through menus and page-plus buttons to change a setting.

That is why we have a physical button or knob for every sound related parameter on the Nord Lead 4 front panel. We also know the importance of building our instruments as light as possible - sometimes it is a long walk to that gig.

Features

The Nord Lead 4 is a virtual analog synthesizer with an extensive set of functions which allow you to shape the sound in a variety of ways. The Lead 4 is multitimbral; its four independent slots make it possible to layer up to four sounds on top of each other.

Synthesizer

In an classic analog style synthesizer environment, each of the Nord Lead 4's four slots consist of 2 oscillators, 2 LFOs, 1 modulation envelope, 1 amplifier envelope and a multi-type filter section with an envelope as well. There is an extensive effects section comprised of six different FX units, and a selectable delay/reverb at the end of the signal path.

- Oscillator 1 can produce analog style waveforms and wavetables. The traditional analog waveforms (Pulse, Triangle, Saw and Sine) can operate in oscillator sync-mode. The Osc 1 Mod section allows the routing of Oscillator 2's pitch to modulate Oscillator 1's pitch - Linear Frequency Modulation.
- Oscillator 2 can produce analog style waveforms and noise. The color and resonance of the noise can be adjusted. The pitch of the second oscillator can be shifted +/- 60 semitones.
- The LFOs have a wide array of modulation destinations and several waveforms. The cycle of an LFO can be restarted by keyboard triggers and/or by pressing an Impulse Morph button.
- The Modulation Envelope has a wide array of modulation destinations and can function either as an attack/decay or as an attack/release envelope. It can be triggered by either the keyboard, or an Impulse Morph button.

- The filter section has envelope and velocity controls and the filter frequency can be set to track the keyboard. The filter has no fewer than seven different characteristics: Low Pass 12 dB slope, Low Pass 24 dB slope. Low Pass 48 dB slope, Band Pass, High Pass and two emulations of classic vintage analog filters, the Ladder M and the Ladder TB filters. The filter has a drive control which allows the addition of some distortion to the signal in the actual filter.
- The arpeggiator, the LFOs and the delay can be synchronized to the Master Clock with individual divisions to create great rhythmic soundscapes.

Continuous Morph

The Morph function lets you control defined ranges of several parameters in a program using the modulation wheel and velocity. This allows you to produce radical changes in a sound.

Impulse Morphs

The Impulse Morph buttons take real-time, instant sound manipulation and creativity to the next level.

Slots

The Slots make it easy to stack up to four sounds in layers or to create split keyboard performances.

Effects

Each program can be processed with the radical FX section and the delay or the reverb.

Programs

There are 396 program locations in the Nord Lead 4. All of these can be used to store your own programs.

Performances

Combinations of four separate programs with interlocking master clock synchronization, with layer, split an/or MIDI control configurations can be stored in the 100 Performance memories.

Nord Sound Manager

The Nord Sound Manager is a free application to use with the Nord Lead 4, as a librarian utility for the programs and performances.

The Nord Sound Manager is compatible with computers running Windows XP, Windows 7 and 8 or Windows Vista, and Macintosh's with Mac OSX 10.4 or later.

2 models - keyboard and tabletop

The Nord Lead 4 comes as a 49-key velocity sensitive keyboard with a modulation wheel and wooden pitch stick, or as a tabletop unit - the Nord Lead 4R. It has 4 line level outputs, 1 headphone output, MIDI IN & OUT, a USB port with MIDI capabilities and inputs for a sustain pedal and a control pedal.

2 Panel Overview



The Panel

The panel on the Nord Lead 4 has two main areas, identified by their black and grey background colors. We will familiarize ourselves briefly with the panel here and describe the functions in detail in the following chapters.

Continuous Morph

The two Continuous Morph buttons are used to set, edit and clear the Velocity and the Modulation Wheel Morph.

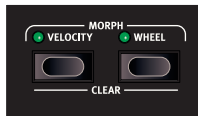

Programs, Performances and Slots

The Program Dial is used to change programs and performances, the corresponding number will be shown in the Display. Programs are shown as two or three digit numbers, performances begin with letters "A" or "b", indication the two banks, followed by numbers 1 to 50. Pressing the Performance button (Perf Mode) will switch between Program and Performance Mode.



There are four Slots in the Nord Lead 4. A Performance can use up to four individual sounds at the same time. Selecting and activating Slots are made with the four Slot buttons, A-D. The Slot buttons are also used to enter the Menus.

Performance controls



The functions in this performance area are used to enable the Hold and Chord Memory features, to split the keyboard, shift octaves and to control the tempo of the Master Clock.



Add expression by bending notes with the Pitch Stick, add vibrato or continuous parameter changes with the Modulation Wheel. The Pitch Bend range can be set for every program.

i Physical Pitch Bend and Mod Wheel controls are not available on the Nord Lead 4R but it will have an identical performance as the keyboard model when it responds to incoming MIDI Pitch Bend and Mod Wheel messages.

The Impulse Morph buttons can activate instant parameter changes in real-time, making it possible to add anything from subtle to very dramatic changes to your performance.

We'll describe the Impulse Morph functions in greater detail starting at page 16.

Synth

The synth area is where all the action happens. Every vital sound generating function in the Nord Lead 4 has a dedicated knob or button. They are all there for you to go ahead, get crazy and design the sound as you wish. Traditional synthesizer functions are expanded with a powerful set of modulation capabilities, rhythmic features like arpeggio with synchronized effects and a delay/reverb. All the settings of the parameters on the panel can be stored in a Program.

Voice Mode

Create fatter sounds by stacking voices "on top of each other" with Unison, make the notes Glide between each other if the Lead 4 is set to Mono or Legato and control the delayed or modulation wheel operated vibrato. These features are enabled with the Voice Mode controls.



LFOs and Modulation Envelope

The two very flexible LFOs have a wide selection of waveforms from sines and squares to ramping saws, perfect for creating wobbling basses or pulsing pads.

Each LFO can easily be synchronized to the Master Clock and assigned a desired time division. The LFO can be re-triggered manually with an Impulse Morph button or a key. The LFO destinations include a unique option to modulate the FX section.

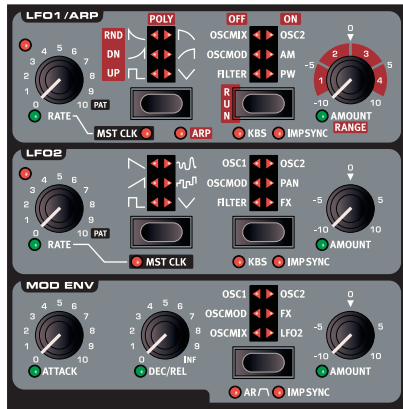

The Nord Lead 4 offers a very capable Modulation Envelope section with an expanded choice of modulation destinations. The Modulation Envelope can also be triggered manually with an Impulse Morph button.

Oscillators

The Nord Lead 4 have 2 oscillators per voice. The classic waveforms are present, Sawtooth, Square, Sine, Triangle, Pulse and PWM.

In addition, the Nord Lead 4 Oscillator 1 section features a wide selection of wavetables including a unique type called Formant wavetables with resonant qualities that are independent of pitch.

Oscillator 2 features a Noise generator with dedicated filter cut-off frequency and resonance controls.



Filter

The filter section features classic 12, 24 and 48 dB Low-Pass, High-Pass and a Band-Pass filters with a ADSR filter envelope and selectable filter tracking.



Two great new filter types are the stunning emulations of the transistor and diode ladder filters from the legendary Mini and the TB-303. The emulations capture the dirty, squeaky resonance of the originals and combined with the new unison mode you'll have plenty of opportunities for making fat, squelchy basses and leads.

The Filter Drive operates separately per voice, distorting the waveform before it passes through the effects sections.

Effects

The FX section contains a bit crusher, a compressor, a tube-style overdrive, two unique talk effects and a comb filter. Together with the delay or reverb, these great sounding effects will put the finishing subtle or quite dramatic touches to the sound.



Knobs & dials

Grab a knob or press a button, it is that easy to change a sound in the Nord Lead 4. There are a few different types of buttons, and some of the controls change their behavior depending on overlying modes that may be activated. Let's look at some of the things you will find and work with on the panel.

Knobs

The knobs control the continuously variable parameters in the Nord Lead 4.

- A parameter value can be totally different from the knob's physical position when you load a Program. As soon as you start turning the knob, the value will 'snap' to the knob's physical position.



Most of the knobs have a green LED indicator below them. This LED indicates when a parameter is connected to a Morph source. Please look at page 16 for more information on morphing.

Some knobs and buttons, like the ones in the LFO 1 area can change their behavior. If the arpeggiator is activated, these controls are instead used to change the settings of the arpeggio. This is indicated with the red labels. The same behavior is used in the Delay/Reverb section and for the Noise parameters for Oscillator 2.

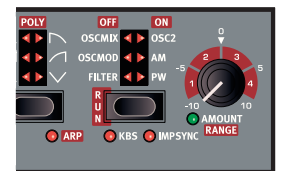

Program Dial

The Program Dial is used to select the programs and performances. When an item in the menus is selected, the Program Dial is used to change this setting.



Oscillator 1 Wavetable dial

This dial in the Oscillator 1 controls has an associated LED display which shows the selected wavetable number.



Master Level

The Master Level knob controls the overall amplitude for the audio outputs, the line level outputs and headphone output. The Master Level knob's actual position indicates the output level.

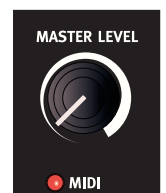

Buttons

On/Off buttons

On/Off buttons are used for activating a parameter or a group of parameters such as effects. The LED next to them indicates the On or Off status.



Shift button

Quite a few buttons have a secondary function, which will be available if you hold down Shift while pressing the button. The name of the secondary function is printed below the button.



Selector buttons

Selector buttons are used to activate a setting in an array of two or more. Selector buttons have a set of round or triangular LEDs to indicate the current setting. Press the button several times to cycle through the possible options.

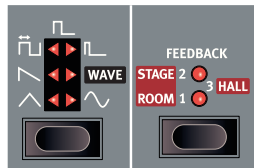

Another example of a selector button can be found in the LFO 1 section, this one has additional settings that are activated with Shifty. Hold Shift and press this button repeatedly to activate the master clock, the arpeggiator or both of these functions, as indicated below the button. The LFO 2 and Modulation Envelope, the Oscillator 2 waveform selector and the Delay Feedback/Reverb algorithm are other examples of this functionality.

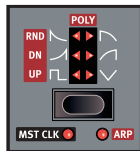

Master Clock (Mst Clk)

The Mst Clk button can be used to set a tempo in two different ways. Tap the button in the tempo you wish to use. The current tempo in BPM will be shown numerically in the Display, and the beats detected in your taps will be indicated with three dots in the lower part of the display.



Hold down the Mst Clk button, and set a tempo by turning the Program Dial.

Copy

The functionality of Copy/Morph Lock button depends on the situation when it is used. Hold it and turn a knob to copy that knob's value to a virtual clipboard, and also to show the parameter value in the Display.



Hold down a Continuous Morph, Impulse Morph or Slot button and press Copy to copy the entire Morph setting or Slot setting (the actual program) to the clipboard.

Morph Lock

If you hold a Continuous or Impulse Morph button and press Copy/Morph Lock, Morph Lock is activated and you can set up the Morph without having to keep on holding the Morph button. Morph Lock is indicated with blinking green LEDs above the Continuous or Impulse Morph buttons.

Morph Lock can also be used to latch an Impulse Morph, to be able to have the Morphed settings of the sound instead of the original.

Paste

To Paste the content of the clipboard, hold Shift, then the Copy/Morph Lock and finally turn the knob or press the corresponding Morph or Slot Button to paste the settings. The pasted setting will be shown in the display when a single parameter is pasted.

3 Getting Started



The Sounds

Complete sound settings are stored in the memory of the Nord Lead 4 as programs and performances. The memory stores 396 programs and 100 performances.

A program is one sound, comprised of all the synthesizer functions that is available on the panel. A performance can be made of up to 4 programs/sounds at once. Pressing the Perf Mode button switches between Program and Performance Mode, programs are shown in the Display as 1._1 - 1.99, all the way up to 4.99. Performances are shown with initial letters "A" or "b" followed by a number between 1 and 50.



Program Mode



Performance Mode

Every program and performance can be changed and replaced as you wish. A complete set of the factory content is available on the Nord Lead 4 CD and on the www.nordkeyboards.com website.

Selecting Programs

- ① With Program Mode is active, turn the Program Dial to select a program. The programs are organized in 4 banks, each with 99 programs.
- ② Hold Shift and turn the Program Dial, this changes the program bank number; the initial 1, 2, 3 and 4.

Editing Programs

Editing a Program is just as easy as grabbing a knob and changing a setting, or pressing a button. A knob's physical position doesn't always reflect the setting in the program that is active, but as soon as you start

turning a knob, the parameter's value will snap to the knob's position.

- ① In Program Mode, select a program and turn for example the Filter Freq knob.

The parameter value will be shown briefly in the Display.

When you have changed any setting in a program, a dot (.) will appear in the Display to the right of the Program number. This is to alert you to the fact that the program have been changed but not yet stored. A program that is active in the Nord Lead 4 is said to be in the Edit Buffer.

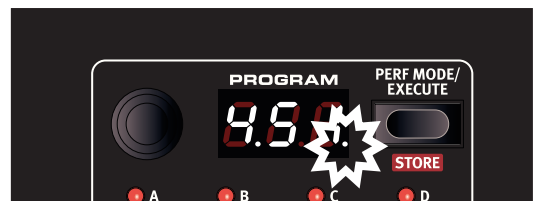

If you select a new program without storing a program that has been changed, any edits you have made will be lost and the program will have its original settings the next time you select it.

Storing a Program

If you are happy with an edit that you have made, you should probably store the program. Before we can do this for the first time, there is a Memory Protect function that is set to On when the Lead 4 leaves the factory. This needs to be turned Off in the System Menu before you (and your cat) can store anything.

- ① Hold Shift and press the Slot A/System button. Turn the Program Dial to select the first setting - "1.ON".
- ② Hold Shift and turn the Program Dial to select "1.OF".

With the protection turned off, we can now store our edited program.

- ③ Hold Shift and press Perf Mode/Store.

The Display starts flashing and the original program location is shown.

- ④ Select a new location where you want to store the program by turning the Program Dial.

To quickly jump to another bank, hold Shift and turn the Program Dial.

The program that occupies the location that you select will be active on the keyboard, making it possible to verify that you do not accidentally overwrite something you wanted to keep.

5 Hold Shift and press the Store a second time to confirm your choice. Your edited program has now replaced the previous one in the location you specified.

- To cancel the store procedure, press any buttons on the panel before you press Store the second time.
- With Memory Protect set to Off, a double tap on Shift + Store will store a program in its original location.

The 4th bank in the Nord Lead 4 memory is empty when shipped from the factory. This means that you can start saving your programs in this Bank at once without having to worry about overwriting anything that you might find useful.

If you at some point like to restore the entire memory content of Nord Lead 4 to the Factory Settings, this can be done with a backup file from the Nordkeyboards.com website and the Nord Sound Manager. This will be described later in this manual.

Slots

The Nord Lead 4 has four Slots labelled A, B, C and D. Each slot represents a complete synthesizer setup, a complete sound if you wish. Slots can be used for layering sounds or quickly switch between programs. Slots can also be used when the Nord Lead 4 is controlled via MIDI.

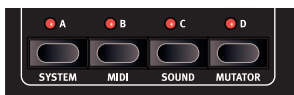

- 1 Press Slot A, its LED should be the only one lit.
- 2 Play on the keyboard and turn the Program Dial to select a program.
- 3 Press Slot B, so that its LED light up instead of Slot A's.
- 4 Turn the Program Dial and choose a different program for Slot B.

By first pressing Slot A and then Slot B buttons, you can quickly switch from one program to another, without turning the Program Dial.

Selecting Performances

- 1 Press the Perf Mode button to select the Performance Mode.



- 2 Turning the Program Dial will scroll through the 100 Performances, A. 1 to b.50. As you will notice, some of the Performances are made with several Slots on top of each other, others are in split configurations with different sounds to either side of the keyboard.

Editing a Performance

It is as easy to edit a performance as it is a Program. Just grab a knob and turn it.

Since a performance may be using up to 4 different programs at once, you need to make sure which of these programs you are editing. The Slot with program that is in focus on the panel, is the one that has the Slot LED blinking.

To replace one of the programs in a performance, hold the Slot button with the program you wish to be changed and turn the Program Dial.

Holding several Slot buttons selects (or de-selects) any combination of the four Slots. When two or more Slots are selected at the same time you are in effect creating a performance, even though it may not be stored as one yet.

Layering two Programs

- 1 Press and hold the Slot A button and then press the Slot B button. Both the Slot A and B LEDs are lit and both programs will be active on the keyboard.

The blinking LED indicates the Slot in focus.

Press the other Slot button to move the focus to the other Slot.

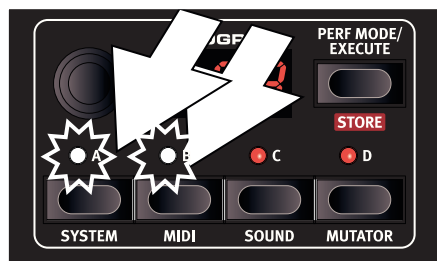

Creating a Split

- 1 Press and hold Slot A and press Slot C. If you do this right after the previous exercise, Slot B is removed.



- 2 Hold Shift and press Split. This splits the keyboard in two halves. Slots A and B will be to the left, Slots C and D to the right.

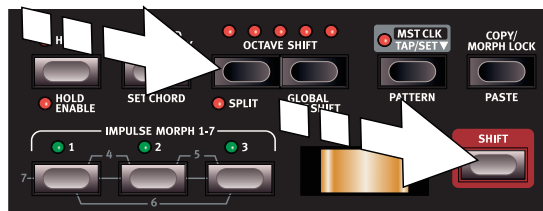

Setting the Split

Hold Shift and press and hold the Split button. A note number will be indicated in the Display. While still holding the buttons, play a key on the keyboard, this key will be the lowest key of the upper range.

Storing a Performance

To Store a combination of Slots that you have made, hold Shift and press Store once. Press Perf Mode to activate Performance Mode, turn the Program Dial to select a location (A, b xx) and confirm by holding Shift and pressing Store once more.

 *The last 10 locations in Performance bank b (b.41 - b.50) are empty when the Nord Lead 4 leaves the factory.*

Shift Editing

Continuous parameters can be changed on all the four Slots in a Performance at the same time. This is done by holding Shift and turning a knob.

The programs will retain the parameter relationship, up until the point when one of them reaches the maximum (or minimum) value. Shift Edit will work on editing Morph settings across the Slots.

Extracting a Program from a Performance

- ① Make sure that the program you wish to store is in the focused Slot.
- ② Hold Shift and press Store once.
- ③ Release the Shift button and Press Perf Mode to switch from Performance- to Program Mode.
- ④ Turn the Program Dial to select a location for the program.
- ⑤ Hold Shift and press Store to confirm your intentions.

Copy and Paste settings

Settings from one Slot can be copied to a virtual clipboard and then be pasted to another Slot. This can be useful if a program needs to be moved from the lower part (A and B) to the upper part (C and D) in a split configuration or if you want a program to be copied from one performance to another.

- ① Make sure that the Slot you wish to copy is in focus.
- ② Hold Copy and press on the source Slot button.
“cP” and a letter that indicates which Slot you have copied will be shown in the Display.
- ③ You can now turn the Program Dial to select a destination performance.
- ④ Hold Shift + Paste, and press the Slot button where you want your settings to be copied to. “Ps” and the destination Slot will be shown in the Display. The settings will be copied to the edit buffer of the performance, the dot to the right in the Display will be lit to indicate this.

The content of the virtual clipboard will remain until you copy another setting or parameter, or turn off the Nord Lead 4. This makes it possible to paste the same data to several destinations.

 *If you want to keep the new settings you have created by copying, make sure to save the program or performance.*

The same procedure can be used to copy individual parameters.

- ① Hold Copy and turn a knob - the source to be copied. The parameters value will be displayed in the Display.

- ② Press Paste (Shift + Copy), and turn another knob - the destination. The setting from the source will now be copied to the destination.

 *The Copy/Paste functionality can be used to copy Morphs from one program to another, and to copy Impulse Morphs within one program or to another.*

MIDI

The Nord Lead 4 default MIDI settings is to send and receive on Global MIDI Channel 1, using the USB MIDI interface. What you play on the keyboard will be transmitted as MIDI Notes on MIDI Channel 1, and incoming MIDI on channel 1 will play the current Program or an entire Performance on the Nord Lead 4.

The Slot that is in focus will be transmitting (and receiving) any CC data that occurs when you turn a knob or press a button on the panel.

All MIDI related settings are made in the MIDI Menu. Read more on the MIDI capabilities of the Nord Lead 4 on page 46.

Multitimbrality

The Nord Lead 4 can be used as four independent synthesizers controlled by MIDI, thanks to the four Slots. This is achieved by setting individual MIDI Channels for the four Slots, in the MIDI Menu.

4 Slots and Memory

General Overview

The Nord Lead 4 is a four part multi timbral synthesizer. This means that you have four independent synthesizers to be used simultaneously. The synthesizers are divided into Slots, where each Slot contains one synthesizer. The Slots are called A, B, C and D.

The panel shows and edits the features of one Slot at a time. Slot focus determines which slot is currently being edited.

A Slot can either be active or not. All active Slots respond to keyboard input as shown in Figure 1. If several Slots are active it is called a layer.

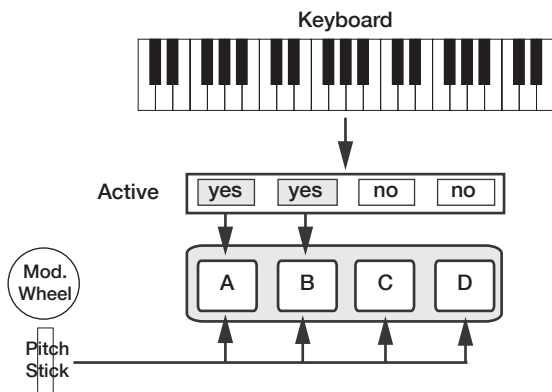

All active Slots respond to keyboard input. Modulation Wheel, Pitch Stick and Control Pedal always reach all slots.

Each of the Slots can listen to different MIDI channels and respond to different keyboard zones. Pitch Stick, Modulation Wheel and Control Pedal reaches all Slots regardless of focus and their active state.

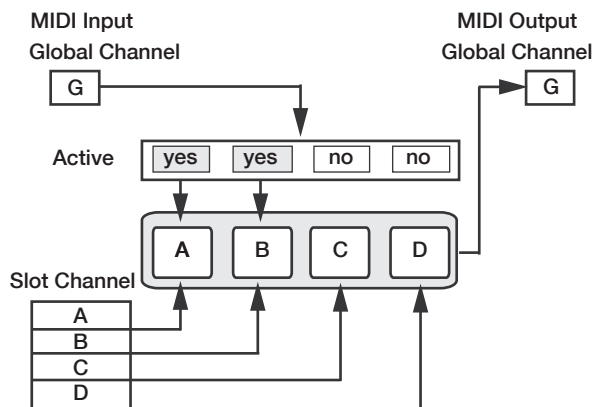

The global channel acts just like playing on the keyboard. The individual slot channels give multi timbrality. MIDI output is always sent on the global channel.

Slot Handling

The Slot buttons, labelled A to D, are used to set the Slot focus, and the active state of the Slots.

To change focus to another Slot, simply press that Slot button. If focus is set to an inactive Slot, that Slot will become active, and the others deactivated.

If only one Slot is active, the focused Slot LED will be lit. When several slots are active, the focused Slot LED will be flashing, and the other active slots will have their LEDs lit.

A layer is created by pressing several Slot buttons at once. You can also hold one of the Slot buttons pressed, then tap another Slot button to activate / deactivate it.

Split

By creating a Split point, the keyboard is divided into two zones, where the lower zone (the left part) plays on Slot A and B, and the upper on Slot C and D. Create a Split Point by holding Shift + Split and pressing the note on the keyboard where you want the Split Point.

Solo

If you double-tap on a Slot button, that Slot enters Solo mode. The other Slots are temporarily deactivated and any audio from them is muted. The Solo mode is indicated with a single flashing Slot LED. Press any Slot button to exit Solo mode and return to the previous state.

Multi Focus

By using Multi Focus, Slot focus can be set to multiple Slots simultaneously. Any changes that are made on the panel then affect all the focused Slots. To turn Multi Focus on, simply press Shift + KB Track and all active slots become focused. The focused Slots are indicated with flashing Slot LEDs.

i *Newer versions of the Nord Lead 4 has the text Multi Focus printed below the KB Track button.*

Program Handling

The Nord Lead 4 handles two different program entities; Programs and Performances. The memory contains 396 Programs divided into 4 banks, and 100 Performances divided into 2 banks.

Programs

A Program contains parameter settings for a single synthesizer Slot. A program can be loaded into any of the Slots.

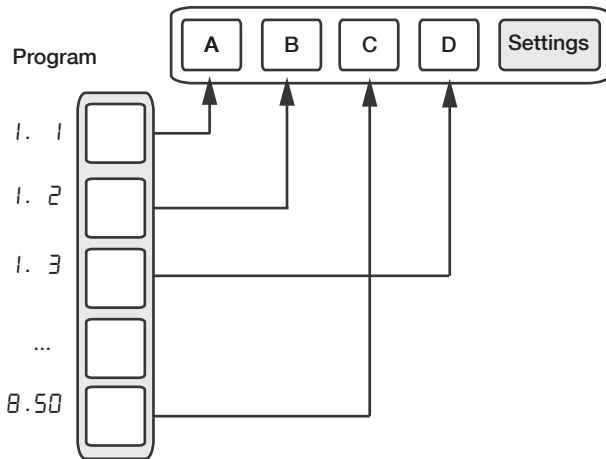

A Program contains parameter data for a single slot.

Performances

A Performance contains parameter data for all four Slots at once. The parameter data for each slot is stored in the Performance – it is not a reference to a Program. Furthermore the Performance contains settings about Slot Focus, Slot Activation, Hold, Split On/Off, Split Point, Keyboard Octave Shift and Multi Focus.

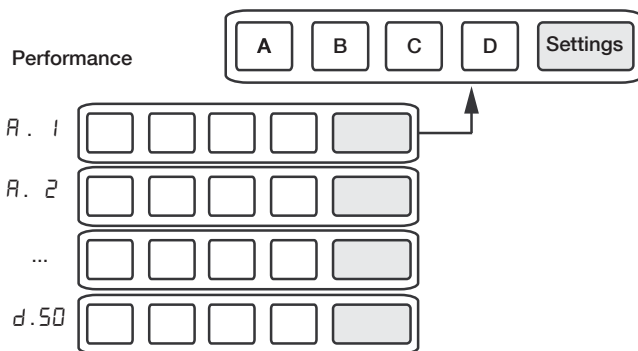

A Performance contains parameter data for all four slots and common settings.

Performance Mode

The Perf Mode button is used to cycle between Performance Mode and Program Mode.

When in Performance Mode the display shows the current bank as a letter: “A” or “B”.

In Program Mode the bank is shown as a single digit “1” to “4”.

Program Mode and Performance Mode have separate Slot buffers.

This means that the changes to you make in Performance Mode, will not affect the Slots in Program Mode, and vice versa.

A Performance is useful not only to create layers, but to load four Slots at once. You can then quickly change between these sounds with the press of a button instead of using the Program Dial.

Loading

To load from memory, simply turn the Program Dial. When in Performance Mode entire Performances are loaded and all Slots are affected. In Program Mode only the focused Slot is loaded, leaving the others untouched.

A Performance can be built from existing Programs by loading separate Slots in Performance Mode. Load the Slot by pressing and holding a Slot button, and turning the Program Dial. The Program is then loaded into the selected Slot, not affecting the others. The program focus for that Slot is stored in the Performance as an indication to where that sound came from.

Storing

Storing works exactly as loading, but the other way around. In Performance Mode all four Slots and their common settings are stored to Performance Memory. In Program Mode, only the focused Slot is stored to Program Memory.

To store a sound, press Shift + Store. The location to where the sound will be stored in Memory will flash on the display. Change the store location by turning the Program Dial. The sound in that location is temporarily loaded so that you can hear what you are about to overwrite. Confirm the store operation by pressing Shift + Store again.

While selecting the store location you can change between Performance and Program Mode. This is very useful to store all Slots as a Performance, or to store one Slot in a Performance as a Program.

Details about storing for the first time can be found in the Getting Started chapter on page 9.

Copying Slots to a Performance

If you have added several slots together with the Lead 4 in Program mode, a Performance can be easily created with this selection. Hold Copy and press Perf Mode to copy the slots and their settings to a Performance. The display will show the current performance bank and two dashes “- -” to alert you that this performance have not yet been stored.

Copying a Performance to Program

It is possible to copy all the individual Slots in a Performance, to become a multi-slot selection in Program mode. While in Performance Mode, hold Copy and press Perf Mode. The Lead 4 will switch from Performance to Program mode, with all the Slot settings as they were in the Performance.

5 Master Clock & Patterns

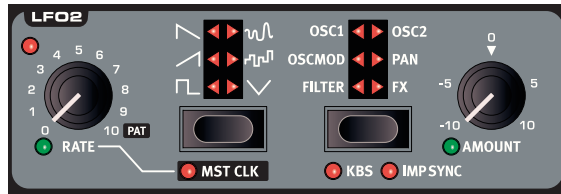
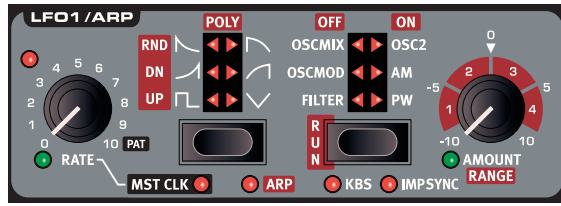

Master Clock

The Master Clock is a feature that can synchronize several functions in the Nord Lead 4 to a common tempo. The LFO 1, arpeggiator, LFO 2 and the delay can be synced to the Master Clock.

The Master Clock tempo has a range between 30 and 300 beats per minute. This tempo can be set manually with the Program Dial, or by tapping to a beat, with the Tap button.

The Master Clock is a global feature that reaches across all four Slots, making it possible to create a synchronized performance with several individual parts.

Master Clock is activated for each individual function that you wish to be synchronized, by enabling “Mst Clk” in that section.

With Mst Clk active, the Rate knobs for the LFOs and the Tempo knob for the Delay will be used to set the Time Division. The divisions can be set to straight divisions like quarter, eighth and sixteenth notes, or triplets, dotted and swing divisions.

Division	Description	Available in
4b, 2b, 1	4 bar, 2 bar & 1 bar divisions.	LFO 1 & 2
2, 4, 8, 16, 32, 64	Half note to 64ths divisions.	Arp, Delay, LFO 1 & 2
4d, 8d, 16d	The quarter, 8th and 16ths “dot-ted” divisions will push the repeats “back” one half of the note value.	Delay
4bt, 2bt, 1t,	4 bar, 2 bar & 1 bar triplet divisions.	LFO 1 & 2
2t, 4t, 8t, 16t, 32t	Half note to 32nd triplet divisions.	Arp, Delay, LFO 1 & 2
4s, 8s, 16s,	Quarter note to 16th swing divisions.	Delay

Divisions are listed on account of their perceived tempo which is why for example triplet quarter notes is found between the dotted eights and the swing eights when you select the Delay divisions.

External Sync

The Master Clock will automatically lock to the tempo of an incoming MIDI Clock. The tempo of the incoming MIDI Clock will be shown in the Display if the Mst Clk button is pressed.

i If you try and manually change the Master Clock tempo when it is being synchronized to a MIDI Clock, “E.Cl” will be displayed in the display.

Arpeggio with Mst Clk

Let’s try out a few things with the arpeggio and the Master Clock.

- 1 Press Sound Init (Shift + Osc 1 waveform selector) to start with a basic sound.
- 2 Hold Shift and press the LFO 1 Waveform selector three times. The Mst Clk and the Arp LED should both be lit. Notice how the three left LFO Destination LEDs light up. This indicates that the arpeggio is stopped.

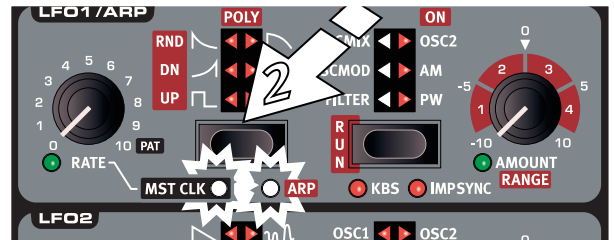

- 3 Hold down a key or a chord and press Run. The three right LFO Destination LEDs light up and the arpeggio starts running.

- 4 Press Hold Enable (Shift + Hold), and then Hold to hold the notes you've played. Each Slot has a Hold Enable control, providing greater flexibility when creating Performances.

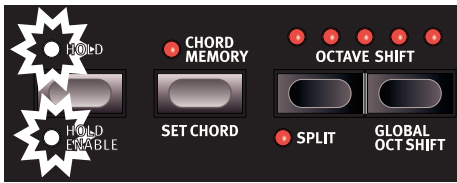

- 5 Turn the LFO Rate knob, to set the division of the arpeggio. Hear the arpeggio speed up or down as the divisions change. Find the quarter note division ("4") and leave it there.



- 6 Hold the Mst Clk button and turn the Program Dial to set a tempo. You can also tap the Mst Clk button to set a tempo. Four taps (or more) are needed to determine a tempo.
- 7 Feel free to adjust the filter and envelope settings to a short, nice sound, I'll wait here. Oh, you're already done? Great, let's move on.

You can change the range of the arpeggio with the LFO 1 Amount/Range knob, from one to four octaves, but let's stick with 1 for now. The LFO 1 Waveform selector acts as the arpeggio direction selection. Press repeatedly to listen to the various directions.

Synced Delay repeats

Keep the arpeggio running and we'll add more things.

- 1 Turn both Delay knobs (Tempo & Dry/Wet) fully counterclockwise, press Feedback once to light up the "1" LED.
- 2 Turn on the Delay, hold Shift and press Delay On a second time to sync the delay to the Master Clock.
- 3 Turn the Delay tempo knob to select the Master Clock "8" division and turn up the Dry/Wet mix until you hear the delay repeats.

The arpeggio will play quarter notes, and the delay repeats will be dotted eight notes (the first repeat will "move" the following repeats by half an 1/8 note).

Sync the LFO

- 4 Lets add a synchronized LFO sweep. Enable the LFO 2 Master Clock sync by holding Shift and pressing the LFO 2 Waveform selector once.
- 5 Select the Triangle waveform and Filter destination.
- 6 Turn the LFO 2 rate to select "2b" (2 bars) and turn up the LFO 2 Amount knob a bit past the 12 o'clock position. If the LFO 2 Amount doesn't seem to do anything, try closing the Filter Frequency a bit.

There are now quarter notes playing from the arpeggiator, with delay repeats that are synced at 8 notes, and the LFO 2 that opens up the filter once every 2 bars.

- 7 Hold the Mst Clk button and turn the Program Dial. The tempo changes and the three rhythmic things we have running in this example all change simultaneously to reflect the new tempo.

A tempo setting will be stored in a Performance.



Patterns

If the LFOs and/or the Arpeggiator are synchronized to the Master Clock, they can use a Pattern, instead of the traditional cyclic or repetitive behavior. To enable the Pattern, turn the Rate knob fully clock-wise - "Pat" will be shown in the Display.

There are 128 Patterns in the Nord Lead 4, with different rhythmic characteristics. Patterns are organized in 6 different types. Some of the Patterns are one bar long, others are longer. Some are in 4/4; others have other time signatures, there are Patterns with shuffle or swing timings as well.

Display	Type
E.	Elementary
S.	Straight
G.	Groove
b.	Back beat
o.	Odd Meter
F.	Fills

Selecting a Pattern

With Mst Clk enabled and the Rate knob turned all the way to the right, hold Shift + Pattern and turn the Program Dial. The Pattern Type and number will be shown in the display.

Pattern changes can be made on the fly using the Impulse Morphs. Hold down an Impulse button (or activate Morph Lock), hold Shift + Pattern and turn the dial to a desired pattern number.

Examples

Let's change the cyclic arpeggio from the example above to a pattern based repetition.

- 1 Make the arpeggio play just one note and turn the LFO 1 rate knob clockwise all the way to the "Pat" symbol. The rhythm of the arpeggio will now be the rhythm of the pattern.
- 2 Hold Shift + Pattern and turn the Program Dial to select the pattern.

Across the Slots

There is one Master Clock tempo for each Performance. All Slots can be in perfect sync with each other.

Sound Menu Kbd Sync

The Sound Menu setting "Mst Clk Kbd Sync" determines if the Master Clock should be reset when you press a key. This type of reset can have a hard or a soft behavior, the softer would allow for note changes slightly ahead of the beat. The Kbd Sync feature can also be turned off, letting the Master Clock run free.

6 Morph



1. Hold



2. Turn

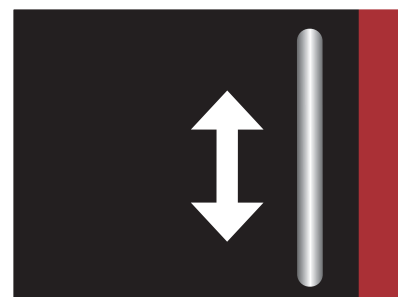

3. Use the Mod Wheel to Morph

Morphing

Morphing allows you to be creative in your sound design, and is all about being able to control virtually any important sound related parameter, in real time from the three Morph sources: the Modulation Wheel & Control Pedal, the Velocity of the keyboard and the Impulse Morph buttons. The Impulse buttons provides you with up to 7 different instant Morph settings for each program.

There are 36 available continuous parameters and 21 “switches” or selectors that can be Morphed. This gives you plenty of real-time control possibilities. A Morph is very simple to set up and use, and all Morph assignments that you make are stored with the Program or Performance.

Many, if not all of the factory programs have morph assigned parameters. If a Program uses Velocity or Wheel Morph, the green Morph Vel or Wheel indicators on the panel will be lit to indicate this.

A Morph Source controls the range from the parameter’s original position in the program, to a position you define when you set up the Morph.

This means that you can control a very small range on one parameter at the same time as you control a very large range on a another parameter. One parameter can be controlled clockwise, and another parameter can be controlled counter clockwise.

Continuous Morphs

Let’s begin with a look at the continuous Morph Sources:



Velocity

This Morph source uses the Note Velocity from the Nord Lead 4 keyboard and from any incoming MIDI messages.

- A key velocity of 0 represents the parameters original setting.
- A key velocity of 127 represents the parameters maximum morphed setting.

Wheel

This allows you to setup the Modulation Wheel and a control pedal as the Morph Source.

💡 *Incoming MIDI Control Change messages CC 01 and CC 11 will also act as a Wheel/Ped Morph source.*

- The bottom position of the Modulation Wheel and/or control pedal represents the parameters original setting.
- The top position of the Modulation Wheel or control pedal represents the parameters morphed setting.

💡 *If the control pedal is set to control the overall volume of the Nord Lead 4, in the System Menu, the wheel will be a solitary Morph source.*

Assign a Morph source to a parameter

- ① Hold down a Morph Source button.
If the Morph has any previously assigned parameters, green parameter LEDs will light up on the panel.
- ② Turn the knob of the parameter you wish to control with the Morph Source, turn the knob to the setting you want as the Morphed setting.
The selected parameter's green LED will indicate that a Morph is active. Previously engaged Morph assignments will be unaffected.
- ③ Release the Morph Source button.
When the Morph source is operated, the parameter's setting will change accordingly and influence the sound.

Continuous Morph parameters

A continuous Morph can control most of the continuous parameters. Each one of these have a green LED next to its knob.

Continuous Parameters		
Glide	OSC 1 MOD Amount	Filter Freq
LFO 1 Rate / Clk Div	OSC MIX	Filter Res
LFO 1 Amount / Arp Rng.	Amp Env Attack	Filter Drive
LFO 2 Rate / Clk Div	Amp Env Decay	Filter Env Amt
LFO 2 Amount	Amp Env Sustain	Output Level
Mod ENV Attack	Amp Env Release	FX Amount
Mod ENV Dec/Rel	Filter Env Attack	Del. Tempo/Clk Div
Mod ENV Amount	Filter Env Decay	Delay Amount
OSC 2 F. Tune/Noise Res	Filter Env Sustain	Rev. Bright
OSC 2 Semit./Noise Freq	Filter Env Release	Rev. Mix

Impulse Morphs

Impulse Morphs are for fast, instantaneous parameter changes. The Impulses can be used to change switch-type parameters, something that the other Morph sources are not able to do.

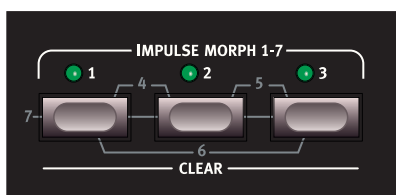

The LEDs above the Impulse Morph buttons do not display that they are used in a program in the same way as the Velocity and Wheel Morphs do, instead they light up when a Impulse Morph is activated.

There are three buttons that can be used in combinations for a total of 7 different Impulse setups for each Program.

Impulse Morph

The Impulse Morphs change the parameters instantly from the original to the morphed setting. They can change switch type parameters, like turning the arpeggiator on or off.

Setting up an Impulse Morphs is done in the same manner as described for the Continuous Morphs.

Impulse Morphable parameters

Oct Shift	Mono Mode	Glide	LFO1 Wave
LFO1 Dest.	LFO1 Rate	LFO1 Amount	LFO1 Clk Division
LFO2 Wave	LFO2 Dest.	LFO2 Amount	LFO2 Clk Division
Mod Env Attack	Mod Env Decay	Mod Env Amount	Mod Env Dest.
Osc1 Waveform	Osc1 Wavet. Sel	Osc2 Waveform	OSC 2 F.Tune/NRes
Osc2 Semi/freq	Osc Mod Select	Osc Mod Amount	Osc Mix Amount
Amp Env Attack	Amp Env Decay	Amp Env Sustain	Amp Env Release
Filt Env Attack	Filt Env Decay	Filt Env Sustain	Filt Env Release
Filter Select	Filter KB Track	Filter Drive	Filter Freq
Filter Res	Filt Env Amount	Output Level	Voice Mode Unis.
Chord Enable	Arpeggio Run	Arp Range	Arp Direction
Arp Tempo	Arp Clk Division	Pattern Select	Delay Clk Div.
Delay Dry/Wet	Dly Feedback	Reverb Type	Reverb Bright.
Delay Tempo	FX Type	FX Amount	

Impulse Morph Protection

The Impulse Morphs have a protection feature. When this is enabled, you have to put the Impulse Morph in Lock mode for any adjustments to stick, otherwise any new parameter settings will be discarded as soon as you release the Impulse button.

This allows parameter changes to be made during the heat of a performance, while not “ruining” a previously set up Impulse Morph. The protection disables the Morph Clear command as well.

- ① Hold Shift and press Slot A to enter the System menu.
- ② Use the Program Dial to select setting 8.
- ③ Hold Shift and turn the Program Dial to set this to Off.

💡 *If the Impulse Morph Protect is On, putting the Impulse Morph in Lock Mode will override the protection.*

Impulse Morph Merge

The Sound Menu has a Impulse Morph Merge feature that allows you to combine settings from Impulse Morphs 1, 2 and 3, to create “mixes” of these to Impulse Morphs 4, 5, 6 and 7.

- ① Make settings to Impulse 1, 2 and 3.
- ② Hold Shift and press the Slot C/Sound button to enter the Sound Menu.
- ③ Turn the Dial until you reach item 5. The LED display will show “rG”.
- ④ Press Execute to merge the first three Impulse Morphs into the remaining four.

Impulse Morphs 1 and 2 will now be merged to become number 4, Impulse 2 and 3 will be merged to number 5, Impulse Morph 1 and 3 will be merged to number 6 and 1, 2 & 3 will be merged as number 7.

💡 *Any parameters that are used in more than one of these first three Impulse Morphs will not be used at all in the merge.*

Editing Morphs

Edit a parameter's Morph range:

- Hold the Morph Source button and turn the destination's knob to a new position.

Clear all parameters assigned to a Morph Source:

- Hold Shift + the Morph Source button that is to be cleared.

Clearing one parameter from a Morph:

- Hold the Morph Source button and turn the parameter knob to its original position. The green parameter Morph LED will be turned off.

Copy and paste a Morph setup

- Hold Copy and press the Morph button(s) that is to be copied to the virtual clipboard. "CPy" will be shown in the Display. Hold Shift and Paste, then press the destination Morph button(s). "Pst" will be shown in the Display.

Morph Lock Mode

Morphs can be locked, making it possible to lift your finger off the Morph button while setting up the Morph. It provides a great overview that can simplify setting up and adjusting multiple Morph Destinations at once.



Morph Lock can also be used in a performance situation if you want to use the Morphed settings of a program or performance for a while.

- 1 Press and hold one of the Morph Source buttons and press Morph Lock.

The Morph Source button flashes continuously, and green LEDs on the panel will show any of the parameters that are assigned to this Morph source.

- 2 Operate a parameter that you want to be Morphed.
Press any of the Morph Source buttons to exit Morph Lock Mode.

7 Mutator



Mutator

The Nord Lead 4 Mutator is a great and easy-to-use tool to spark the creative process with totally new or just slightly changed programs. Make a few selections on process and strength, and execute a mutation of a sound for as many times you want. There is even an Undo feature that can reverse the mutation step by step if a mutation winds up with no eyebrows, thumbs on the knees and six nipples.

Process and Strength

The Mutator has three different selectable processes. The A and B processes have variable strengths and both will use the current Program as a starting point. The strength setting (1-5) determines how "different" the result will be compared to the original.

Process A

Process A generates the programs by means of a variation algorithm. It is always the current, - the mother - program that will be subjected to the variation process, no matter how many times the process is executed. Program X will become X1, then next mutation can be described as X2, the next after that as X3 and so on.

Process B

Process B uses a mutation algorithm; the difference from Process A comes into action when the process is executed more than once. Process B will interpolate an evolution from the mother program, but looks at the previous result when the mutation is executed again. Program V mutates to VX, the next mutation becomes XY, then one after that will be YZ, and so on.

Random

The Rnd option is a totally random process that does not consider any current or previous Programs, music styles, fashions or personal taste of the Nord developer that created this algorithm.

Executing the Mutation

The Nord Lead 4 Mutator uses probability and degrees of preservation, together with the level of strength that is chosen. Some parameters are less likely to be changed than others. As an example, if the original program uses the Arpeggiator, it is unlikely that this will be turned off. The arpeggio rate/division and range will however be subject to changes.

The Mutator algorithms will try and keep the character of a sound, at least as long as one of the first three levels of strength is used. The amount of variation increases from a small change of continuous parameters values and no change for the switch/selector parameters at strength 1, to a big change for both types of parameters, at the 5th strength level.

i *The output level parameter is never changed. If a variation or mutation is silent, this may be caused by a closed filter or amp envelope settings.*

If Process A1 is executed several times, the filter settings, envelopes, and modulation rates and amounts will change since they are continuous parameters. The filter types, oscillator waveforms and modulation destinations will not change, since these are selector type parameters.

Turn up the strength to A3 and you'll find that modulation destinations and oscillator waveforms will be altered as well. A5 will create the greatest changes, where for example the FX on/off status and the Arpeggiator on/off is included in the parameters that will be changed.

Try Mutating a program that is initialized, and use only the A1 process for about ten times. Then initialize the program again, and switch to the B1 process.

💡 *Try Mutating a Program that has the arpeggio running in a Performance.*

Undo a Mutation

When the previous sound was the one that you would have wanted to keep, use Undo. Hold Copy and turn the Program Dial counter-clockwise. You can undo the last 10 mutations.

Mutator Examples

Let's have a look at the three different generation methods, Variation, Mutation and Random.

- ① We will begin by initializing a program - hold Shift and press the Osc 1 Waveform selector button.
- ② Turn the Osx Mix knob to hear both oscillators, and set the waveforms so that you can tell oscillators 1 and 2 apart.
- ③ Enter the Mutator (Shift + Slot D).
The available settings are printed on the right side of the panel.
- ④ Select A1 and press Perf Mode/Execute once.



"A" indicates that this is the Variation mode and "1" is the least dramatic process strength. Listen to the sound and try to hear any likeness to the original sound that you had before you pressed Execute.

- ⑤ Press Execute again, without changing the mode or level - A1.
The Variation process will start all over again, and it will again use the original sound that we made in step 2, as the source, not the Variation created in step 4.
- ⑥ Listen to the sound and see if you can find out what parameters have changed.
- ⑦ Turn the dial to A5 and press Execute. This will most certainly generate a program that is quite different from the initialized sound in step 2.
There is a chance that you need to make some adjustments in order to make this sound keyboard-playable.
- ⑧ Hold Copy and turn the dial one step at a time counter clockwise.



The Display will count down from -1 for each step. This is the Undo feature with which you can undo mutations.

💡 *There are 10 undo levels, if you've pressed Execute more than 10 times, you need to restore the original program by selecting it again.*

Lets try the Mutation process.

- ① Initialize the program and and make some adjustments to the oscillator mix and waveforms so that you can tell them apart.
- ② Enter the Mutator (Shift + Slot D).
- ③ Select b1 and press Execute. "b1" is the least dramatic Mutation level, and you should be able to hear a sound that is not too far away from our starting point.
- ④ Press Execute again. The Mutation will now use the previous mutation result and generate new settings on the basis of that.

This is the difference between the A and the b processes. The b/ Mutation will always continue from a previous result, the A/Variation will do another variation of the original source program.

If a Mutation is going in the right direction, you can continue with another Mutation.

- ⑤ Select RND with the Dial and press Execute.



This will be a true randomization. Almost any parameter in the Lead 4 will be randomized, and you may have to adjust several settings for the result to be playable on the keyboard.

8 Panel Reference

Master Level

The Master Level knob controls the overall amplitude for the audio outputs - the line level outputs and the headphone output. The knob's physical position indicates the output level and is not stored in a Program.

 If you need to adjust the output level in individual programs, use the Output parameter in the upper right area on the panel. The setting of that control is stored in a program.

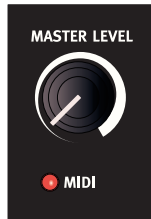

MIDI LED

The MIDI LED will indicate incoming MIDI messages by briefly lighting up.

Short LED flashes indicates that MIDI messages are received but not used in any way by the Nord Lead 4. Longer flashes are indications that the MIDI messages are actually recognized. This applies to messages on MIDI channels that are in use, CC messages that will change Nord Lead 4 parameters, etc..

Continuous Morphs (Morph)

Continuous Morphs are used to gradually change one or several parameters with the Morph Controls - the keyboard velocity and the Modulation Wheel and Control pedal - while you are playing.

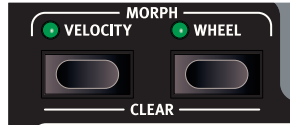

Hold a Morph button and turn a knob to set the connection between the Morph control, the parameter destination and the range of the Morph control.

Velocity

The Velocity Continuous Morph control use the striking force on the Nord Lead 4 keyboard or incoming MIDI messages to control one or several destinations.

- A key velocity of 0 represents the parameters original setting.
- A key velocity of 127 represents the parameters morphed setting.

Velocity Morph Destinations			
LFO1 Rate	LFO1 Amount	LFO1 Clk Division	
LFO2 Rate	LFO2 Amount	LFO2 Clk Division	
Glide	Mod Env Attack	Mod Env Dec/Rel	Mod Env Amount
Osc2 Semi/N Freq	Osc2 Fine/N Res	Osc Mod Amount	Osc Mix Amount
Amp Env Attack	Amp Env Decay	Amp Env Sustain	Amp Env Rel.
Filt Env Attack	Filt Env Decay	Filt Env Sustain	Filt Env Release
Filter Drive	Filter Freq	Filter Res	Filt Env Amount
Output Level	Arp Range	Arp Tempo	FX Amount
Rev/Del Dry/Wet	Delay Tempo	Reverb Bright.	

Modulation Wheel

The Modulation Wheel or a control pedal is an excellent Morph control, great for adding drastic or subtle, continuous parameter changes during a performance.

Incoming MIDI Control Change messages CC01 and CC11 will also act as a Modulation Wheel and pedal Morph control.

- The bottom position of the Modulation Wheel or control pedal represents the original setting of the parameter.
- The top position of the Modulation Wheel or Control Pedal represents the morphed setting of the parameter.

For a detailed description on how to set up a Morph scenario, please look at page 16.

Modulation Wheel Morph Destinations			
LFO1 Rate	LFO1 Amount	LFO1 Clk Division	
LFO2 Rate	LFO2 Amount	LFO2 Clk Div.	
Glide	Mod Env Attack	Mod Env Dec/Rel	Mod Env Amt
Osc2 Semi/N Freq	Osc2 Fine/N Res	Osc Mod Amount	Osc Mix Amount
Amp Env Attack	Amp Env Decay	Amp Env Sustain	Amp Env Release
Filt Env Attack	Filt Env Decay	Filt Env Sustain	Filt Env Release
Filter Drive	Filter Freq	Filter Res	Filt Env Amount
Output Level	Arp Range	Arp Tempo	Arp Clk Division
Delay Clk Div.	Delay Dry/Wet	Delay Tempo	Reverb Bright.
FX Type	FX Amount		

 There is a limit on how many Morph Destinations a program can use; 87 for the synth parameters and 24 for the FX/Reverb/Delay. If you reach this limit during the setup of a Morph, the green Morph LED next to a knob will not be lit. If a copy/paste procedure will exceed the available amount, the Display will show "FuL".

Clear Continuous Morphs

Hold Shift and press a Morph button to clear all assignments for that Morph control.

Program Dial

Turn the Program Dial to select programs or performances.



When any of the Menus are entered, the Program Dial is used to select menu functions and to change settings (Shift + turn).

The Program Dial is endless, though the array of parameter settings are not. Once you reach the first or last possible setting, turning the Program Dial further will have no effect.

 The Program Dial has an accelerator feature; when operated swiftly you scroll through values in larger increments.

LED Display

The LED Display will show which Program or Performance is active. Menu functions, menu settings, confirmation of executed actions and parameter values are also displayed when appropriate.



Performance Mode

Pressing the Perf Mode button will cycle between Program and Performance Mode. Programs are shown in the LED Display as a two or three digit number between 1. 1 and 4.99. This mode is typically used to play on one Slot, one program at a time.



Performances can use up to 4 slots with 4 simultaneous programs in various combinations - splits, layers, keyboard controlled and MIDI input. Performances are indicated by initial letters "A" or "b", followed by a number from 1 to 50.

Execute

Commands and actions - such as the Store command and actions that are found in the Menus - that needs confirmation will be indicated by flashing in the Display. Press Execute to confirm or to start the action or the process.

Store

Store is used when Program or Performance settings are to be stored in the Nord Lead 4 memory. Read more about the Store procedure on page 9.



Slot A - D buttons

The Nord Lead 4 has 4 Slots, labeled A to D. Each Slot can be loaded with one program. Slots can be used one by one in Program Mode or together in Performance Mode.

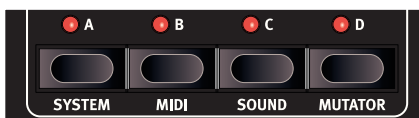

The Slot buttons can be used to quickly change from one program in one Slot A to another Program in another Slot.

Press and hold several Slot buttons to use them at the same time in a layer or split configuration. Any combination of the four slots is possible, by pressing two or more Slot buttons at the same time.

Hold a Slot button and turn the Program Dial to load another program in that Slot.

Double-click on an active Slot in a multi-slot selection to de-select all the other Slots. To turn off a selection where all four Slots are included, press all four Slot buttons again.

If several Slots are active, the slot with the flashing Slot LED has the Panel focus, the knobs and buttons on the panel will change the program in that Slot. Press an active Slot button to shift the Panel focus.

Multi Focus

Multi Focus allows you to change settings simultaneously on all the active Slots in a performance (or a multi-Slot scenario). Press Shift + KB Track and all the active Slot's LEDs will flash. Any parameter change you make on the panel will affect all the Slots. Active Multi Focus will be stored in a performance.

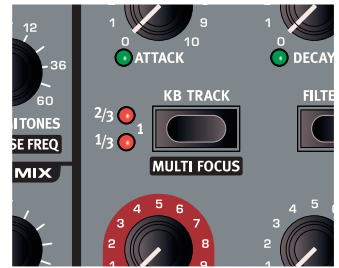

i Early versions of the Nord Lead 4 will not have the text Multi Focus printed on the panel.

System - MIDI - Sound - Mutator

Shift and the Slot A, B or C buttons enters the menus where global settings are made. Read more about the menu settings on page 43.

Shift + Slot D brings up the automatic program generator, the Mutator.

Hold

Use Hold together with Hold Enable to create notes and chords with infinite length, they will continue to sound when keys are released. This can be used to create drones or hold arpeggios.



Hold Enable

A program must have Hold Enable active to be held with the Hold feature. The separate Hold Enable feature makes it possible to Hold only selected programs in a performance.

Chord Memory

Chord Memory memorizes note intervals and automatically add these to notes that are played.

Chord Memory settings are stored in a Program.



Set Chord

Note intervals are set and Chord Memory will be activated by combining panel and keyboard actions.

1 Play and hold a chord while Chord Memory is Off, hold Shift and press the Chord Memory button.

i If you want chords that are bigger than Rachmaninov could reach, use the sustain pedal.

2 Release the Chord button first, then the chord. The LED will show: "Set".

The four lowest keys in the chord will be memorized and the Chord Memory function is activated. The lowest key in the chord will act as the root key.

Deactivating a Chord Memory

1 Press the Chord Memory button to deactivate the Chord Memory function.

Once deactivated, press at any time the chord button again to re-activate the previous Chord Memory.

- ⚠ *Several voices will be used in the Chord Memory function, this reduces the polyphony.*
- 💡 *Only the actual key(s) you play will output MIDI Note information - not the intervals included in the Chord Memory.*

Octave Shift

Transpose the sound in the focused Slot with the Octave Shift buttons.

Range: -24, -12, 0, +12, +24

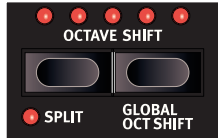

No octave shift is applied when the center LED is lit.

- LEDs to the right of the center LED will indicate a shift upwards.
- LEDs to the left of the center LED will indicate a shift downwards.
- 💡 *Keyboard messages from the Nord Lead 4's MIDI Out will not be transposed.*

Global Octave Shift

Global Oct Shift (Shift + Octave Shift down) transposes the keyboard in octaves for the entire instrument. This is not a programmable parameter, a setting will apply until you change it. The LEDs will be in an inverted state to indicate that you are in the Global Octave Shift mode.

- MIDI Note messages at the MIDI output will be transposed.
- ⚠ *A combination of extreme Octave Shift and OSC 2's Semi Tone setting can produce sounds that are outside the hearing range.*

Split

Split divides the keyboard in two halves. Slots C and D are controlled by the upper half, Slots A and B by the lower half.



Hold Shift + Split and press a key on the keyboard to set the split point. The key you press is indicated in the Display and will become the lowest key of the upper range.

Master Clock (Mst Clk)

Hold the Mst Clk button to set the tempo of the Master Clock with the Program Dial. The tempo can be set from 30 to 300 BPM.



Tap/Set

Tap the Mst Clk button to set a Master Clock tempo. You need four taps to make a change, more taps can be used after those initial four. The first tap will show the current tempo in the Display, the three taps after the first will present a dot that moves across the bottom of the display to indicate the position of the taps in the 4/4 beat.

Pattern

Hold Pattern (Shift + Mst Clk) and turn the Program Dial to select a Pattern. Patterns are categorized, this is indicated by an initial letter in the display, which is followed by a pattern number. Read more about Patterns on page 15.



- 💡 *The Pattern selection is a Morphable parameter. You can jump to a new pattern by pressing an Impulse Morph button.*

Copy

Copy settings to be pasted to new destinations, and to see individual parameter settings. Hold Copy and press a Morph or Slot button, or operate a knob to copy the setting(s) to a virtual clipboard.



Copies can be made from Continuous Morphs, Impulse Morphs and entire Slots (complete Programs), as well as single parameters. A copy can be pasted several times, the content of the clip board is kept until another copy is made or the Nord Lead 4 is turned off.

“Copy” (followed by a number or letter when appropriate) will be displayed in the Display when a Continuous Morph, Impulse Morph or a Slot is copied. A parameter's value is shown in the display when they are copied.

- 💡 *An active Impulse Morph can be copied and pasted to a Slot to create a new program, with all the parameter changes from the Impulse Morph. Hold the Impulse Morph button, press Copy. Paste the copied settings to a Slot (Shift + Paste + Slot button).*

Morph Lock

Lock the Morph to be able to lift your finger off the Morph Control button while setting up or adjusting a Morph. Press Morph Lock while holding a Morph Control button. The Morph Control indicator will flash, and any green Morph parameter LEDs that are associated with this control will be lit on the panel.

When a Morph is Locked, hold down Shift and operate a parameter knob to clear the parameter's Morph association

- 💡 *Press any of the other Morph Control buttons to exit Morph Lock.*

Paste

Hold Paste (Shift + Copy/Morph Lock) and select a destination to paste the copied data. “PSt” (or the value of a single parameter) will be displayed in the Display.



Impulse Morph 1 - 7

The Impulse Morphs are used to make instant changes to the settings of one or several parameters.

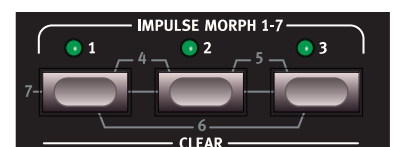

By combining two or all three buttons, you have a total of 7 Impulse Morphs available in each program. Impulse Morphs can control both continuous parameters and switch-type parameters. Read more about Impulse Morphs on page 17.

Impulse Morph destinations

Oct Shift	Mono Mode	Glide	LFO1 Wave
LFO1 Dest.	LFO1 Rate	LFO1 Amount	LFO1 Clk Division
LFO2 Wave	LFO2 Dest.	LFO2 Rate	LFO2 Amount
LFO2 Clk Division	Mod Env Attack	Mod Env Decay	Mod Env Amount
Mod Env Dest.	Osc1 Waveform	Osc1 Wavet. Sel	Osc2 Waveform
Osc2 Fine/N Res	Osc2 Semi/N Freq	Osc Mod Select	Osc Mod Amount
Osc Mix Amount	Amp Env Attack	Amp Env Decay	Amp Env Sustain
Amp Env Release	Filt Env Attack	Filt Env Decay	Filt Env Sustain
Filt Env Release	Filter Select	Filter KB Track	Filter Drive
Filter Freq	Filter Res	Filt Env Amount	Output Level
Voice Mode Unis.	Chord Enable	Arpeggio Run	Arp Range
Arp Direction	Arp Tempo	Arp Clk Division	Pattern Select
Delay Clk Div.	Delay Dry/Wet	Dly Feedback	Reverb Type
Reverb Bright.	Delay Tempo	FX Type	FX Amount

- Unison 1 adds one slightly de-tuned voice, slightly panned and with no decrease in polyphony.
- Unison 2 adds two extra voices, with increased de-tuning and panning, each key will use three voices of polyphony.
- Unison 3 adds three extra voices, with even more de-tuning and panning, each key will use four voices of polyphony.

Vibrato (Dly Vib, Whl)

The Dly Vib1 and Dly Vib2 settings adds a delayed vibrato, the delay time being 0.5 and 1.0 seconds.



When Whl is selected, the depth of the vibrato is manually controlled by the Modulation Wheel.

The vibrato rate and the depth of the delayed vibrato is set in the Sound Menu.

Pitch Stick

The Pitch Stick is used to bend notes. The range is set with the Bend Range parameter, see page 24.



Shift

Shift is used together with other buttons to access additional functions. The name of the additional functions are printed below the buttons.



Hold Shift and turn a knob, to change a parameter for all active Slots in a Performance at the same time. The individual relationship of the parameters will be retained. This also applies to Impulse and Continuous Morphs.

Mono

Mono makes the Slot monophonic, only one note at a time will be heard. The envelopes will be re-triggered for each new note you play.



Legato

Legato is another monophonic mode. The envelopes will not be triggered if you play legato, they will continue in their present phase.

Legato is when you play a key without releasing a previously played key.

Glide

Glide can be used to set the time interval for the pitch to glide from one note to a new note, when Mono or Legato is active. With a setting of zero the pitch will change instantly.

If Legato is active, Glide will only occur if you play legato.

Modulation Wheel

The Modulation Wheel can add vibrato if the Vibrato Voice Mode setting is set to "WHL" and/or act as a Morph Control, to control one or several parameters while you perform.

Voice Mode

Voice Mode parameters are used to stack voices on top of each other for a fatter sound, to set a monophonic behavior, and to add glide and vibrato.

Unison

Unison stacks de-tuned voices "on top of each other," in the same fashion as on the classic analog polyphonic synthesizers. Unison will position voices left and right with various strengths in the stereo panorama.



Bend Range

Bend Range can be set up to a maximum of +/- 4 octaves. There is also two settings with different ranges for the upward and downward bend.



Press Bend Range (Shift + Mono/Legato) repeatedly. The first press will display the current setting, each consecutive press will increase the bend range one step at a time.

Hold Bend Range and turn the Program Dial to scroll through the available settings.

Bend Range	Description
1 - 12, 24, 48	Pitch Bend range in semitones.
-12, -24	Pitch Bend range is 2 semitones for upward bends, and 12 or 24 semitones for downward bends.

Low Frequency Oscillators (LFO)

Low Frequency Oscillators (LFO) produce waveforms just like the ordinary oscillators, but with a few differences:

- LFOs are capable of generating waveforms with a very low frequency.
- LFOs are used for modulating other functions, like for example pulse widths, the pitch of the oscillators or the filter Cut Off Frequency.

There are two LFOs in the Nord Lead 4, with slightly different features.

i The LFOs in the Nord Lead 4 are monophonic.

LFO 1

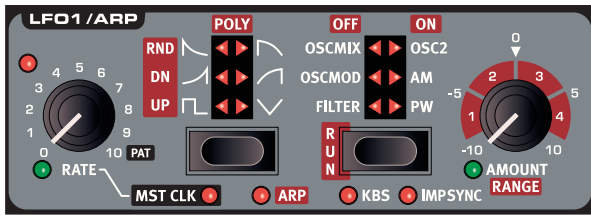

LFO 2

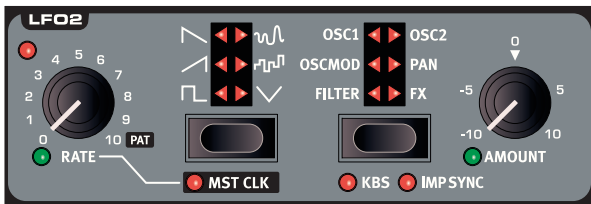

Rate

The Rate knob sets the frequency of the LFO.

Range: 0.03 to 523 Hz

The red LED to the upper left of the Rate knobs indicate the rate of the LFO.

Pat

If an LFO is synchronized to the Master Clock and the Rate knob is turned all the way to the right, the LFO cyclic waveform will be replaced by a Pattern. Read more about Patterns on page 15.

Waveform Selector

The two LFOs have different sets of available waveforms.

Waveform	Description	LFO1	LFO2
	Square Used for abrupt modulation changes, suitable for trills, distinct tremolos, etc.	✓	✓
	Sawtooth Used for linear ramp type modulations.		✓
	Inverted Sawtooth Inverted linear ramp.		✓
	Nonlinear Sawtooth 1 Ramp that drops faster than the linear.	✓	
	Nonlinear Inverted Sawtooth Ramp that "is speeding up".	✓	
	Nonlinear Sawtooth 2 Ramp that drops a bit slower.	✓	
	Inverted Nonlinear Sawtooth 2 Ramp that speeds up a bit slower.	✓	

Waveform	Description	LFO1	LFO2
	Triangle Suitable for natural vibrato effects and good for classic pulse width modulation.	✓	✓
	Stepped Random Creates a modulation with abrupt random changes.		✓
	Smooth Random Creates a smooth random modulation.		✓

LFO Destination Selector

Select the destination to be modulated by the LFO.

Destination	Description	LFO1	LFO2
Filter	Modulates the Filter Frequency.	✓	✓
OSC MOD	Modulates the Oscillator Modulation Amount.	✓	✓
OSC MIX	Modulates the Oscillator Mix Amount	✓	
OSC 1	Modulates the pitch of Osc 1.		✓
OSC 2	Modulates the pitch of Osc 2.	✓	✓
OSC 1 & 2	Modulates the pitch of both oscillators.		✓
AM	Modulates the amplitude.	✓	
Pan	Modulates the position in the stereo panorama.		✓
PW	Modulates the oscillator pulse width.	✓	
FX	Modulates the FX amount.		✓

Amount

This control sets the amount of the LFO modulation. At the center detented 12 o'clock position, the modulation is zero. Turn left to get negative modulation, turn right to get positive.



Range: -10 to +10

LFO Modulation Polarities

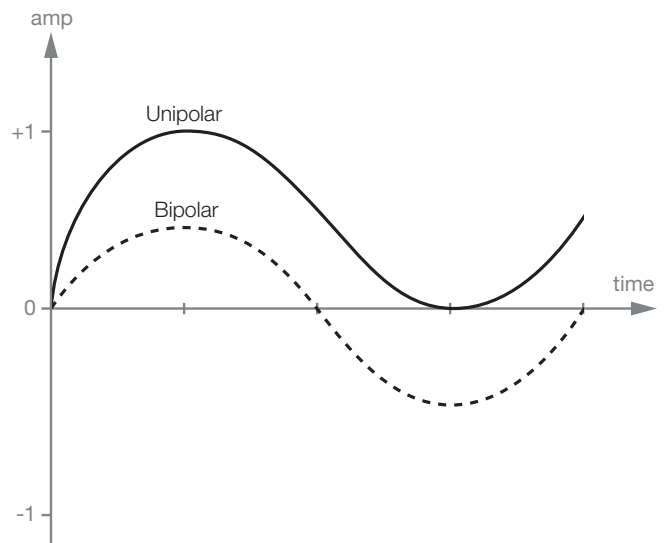

The modulation of the LFOs are unipolar, with a few exceptions. Pitch (OSC1, OSC2) and PW modulations with triangle, S&H and Random waveforms are bipolar. Pan modulation with all waveforms are bipolar.

Master Clock (Mst Clk)



Enable Mst Clk to synchronize the LFOs and Arpeggiator to the Master Clock. The LFO Rate knob will control the time division instead of the rate.

Division	Description
4b, 2b, 1, 2, 4, 8, 16, 32, 64	The straight divisions range from 4 bars to 1/64 notes.
4bt, 2bt, 1t, 2t, 4t, 8t, 16t, 32t	The t indicates the triplet divisions, from 4 bars to 1/32 notes.

Arpeggio (Arp)



LFO 1 can be exchanged for an arpeggiator. The arpeggio parameters with the red labels controls direction, range and speed of the arpeggio.

i When the Arpeggiator is active, LFO 1 is disabled.

Keyboard Sync (KBS)



When KBS is enabled the LFO cycle will be restarted when a key is pressed.

i All held keys must be released before a restart occurs.

Impulse Morph Sync (Imp Sync)



The LFO cycle will be restarted when any Impulse Morph button is pressed, if Imp Sync is enabled.

Arpeggiator

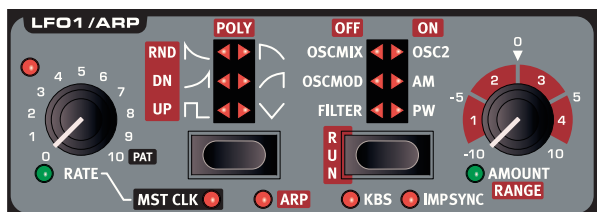

When the arpeggiator is activated, the controls in the LFO 1 section will be used for the arpeggio parameters, these are identified by the red background.

Rate

The tempo of the arpeggio is set by the Rate knob, the range is from 30 to 300 BPM. If the arpeggiator is locked to the Master Clock, Rate will select the divisions or activate the Pattern feature, if turned fully to the right.

Arpeggiator Divisions

Division	Description
2, 4, 8, 16, 32	The straight divisions range from 1/2 notes to 1/32 notes.
2t, 4t, 8t, 16t	The t indicates the triplet divisions.

Pat

When the arpeggiator is locked to the Master Clock and the rate knob is fully to the right, the "rhythm" in the arpeggio will be set by a pattern, instead of the repetitive cycle.

Arpeggio Directions

The arpeggio directions are: Up, Down, Up/Down, Rnd (random) and Poly. Poly will not break up a chord you play in single arpeggiated notes, it will arpeggiate the entire chord.

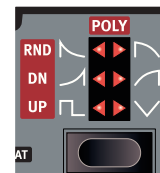

Arpeggio Run

Starts and stops the arpeggiator. The LFO 1 Destination LEDs will indicate Run or Stopped status.

Arpeggio Range

The arpeggiator has an range from 1 to 4 octaves.

i A Poly arpeggio range set to 2, 3 and 4 will play through the chord inversions.



Modulation Envelope



The polyphonic Modulation Envelope can be used to modulate functions in the Nord Lead 4. It is an Attack/Decay envelope that can be changed to Attack/Release operation. It will be triggered when you press a key, just like the Amp and Filter envelopes but it can also be triggered with the Impulse Morph buttons. The modulation can be positive or negative at the destination, this is determined by the Mod Env Amount control. The illustration below show a modulation envelope that modulates with a positive amount, with Attack and Decay parameters.

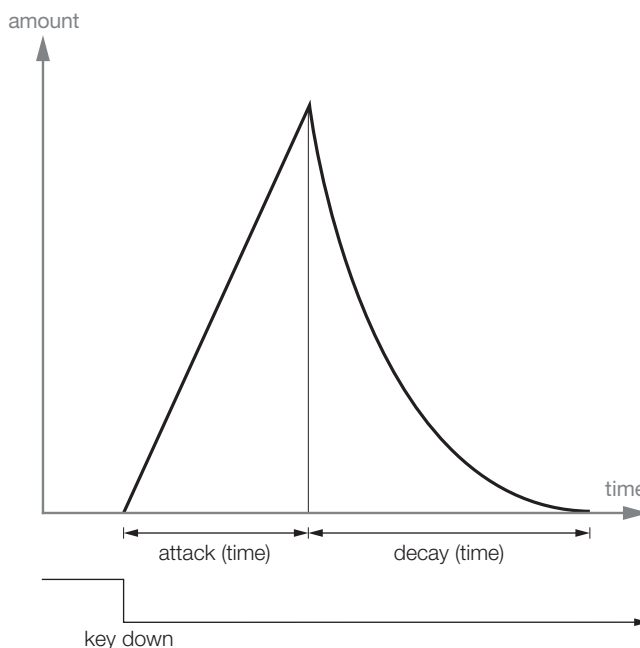

This is the modulation envelope in the AR (Attack and Release) mode.

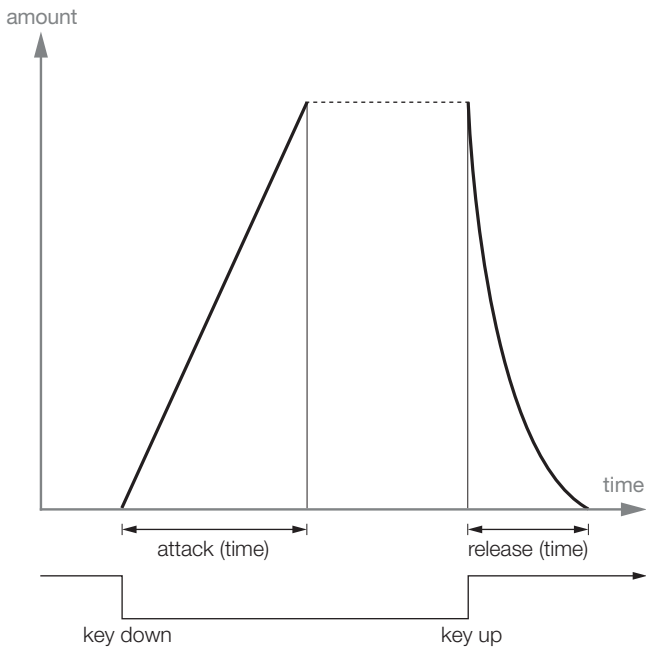

Attack

Attack is the time it takes for the modulation envelope to reach the maximum modulation level. This envelope phase begins when you press a key.

Range: 0.45 ms to 45 s



Decay/Release (Dec/Rel)

Decay begins after the attack phase is completed. It is the time it takes for the modulation envelope to fall back to zero modulation again. If A/R mode is active, the release phase will begin when the key is released.

If Dec/Rel is turned fully clockwise, the decay or release time will be infinite.

Infinite Decay or Release times acts a Sustain levels on all destinations with one exception: Osc 1 and Osc 2 pitches are not modulated at all by a Mod Envelope Release that is set to infinite.

Range: 3.0 ms to 45 s, Infinite

Destination selector

Select the destination for the modulation from the envelope. The modulation amount will be summed with any other modulation that occurs at the destination.

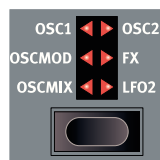

Panel	Description
OSCMIX	The Oscillator Mix parameter.
OSCMOD	The Oscillator Modulation Amount parameter.
OSC1	The pitch of oscillator 1.
OSC2	The pitch of oscillator 2.
OSC1 + OSC2	The pitch of both oscillators.
FX	The Amount of the FX.
LFO2	The Amount of LFO2.

The Modulation Envelope will be monophonic when FX is used as the modulation destination.

When the modulation envelope is used to modulate oscillator pitch in A(S)R-mode, the sustain phase of the envelope will be the nominal pitch of the oscillator.

AR mode

Selecting A/R changes the Attack/Decay envelope to a Attack/(Sustain)/Release envelope.

Impulse Morph Sync (Imp Sync)

The Modulation Envelope will be restarted when an Impulse Morph button is pressed if Impulse Sync is enabled.

Enabling Imp Sync makes the Modulation Envelope monophonic.

Amount

Amount sets the strength of the envelope modulation. At the center detented 12 o'clock position, the modulation is zero. Turn left to get negative modulation, turn right to get positive.

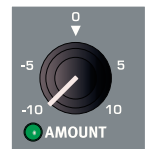

Oscillators

The oscillator is the foundation of the sound in a synthesizer. It produces the waveform with a harmonic content. This important property of the sound can be shaped and/or modulated later in the signal path.

There are two oscillators in the Nord Lead 4. You can mix the output of the two, and detune them for a fatter sound. One oscillator can also modulate the other, creating very complex and constantly changing harmonic structures.

Oscillator 1



Triangle

The triangle waveform is quite soft in its character with only odd numbered and not very strong harmonics.

Sawtooth

The sawtooth waveform produces a very rich sound that contains both even and odd numbered harmonics.

Pulse

The pulse waveform has a hollow character. At a 50% width it produces only odd numbered harmonics. If the width becomes narrower, more odd and even numbered harmonics will be present.

The pulse have three available settings, one with a 50% width that can be modulated by LFO 1 (PWM) and two fixed widths, 10% and 33%.

Wavetables (Wave)

The wavetables in Oscillator 1 are single cycle, digital waveforms that provides rich and interesting timbres, with various tonal characteristics.

There are 128 wavetables, organized in the following groups.

Group	Description
Analog	Analog style with additional harmonic structures.
Bells/Tines	Good for metallic, percussive sounds.
Classic	Harmonics inspired by acoustic instruments.
Digital	Digital synthesis waveforms.
Electric	Everything from subtle to nasty electrics.
Formants	Vocal sounds, quality/harmonics not affected by pitch.
Organs	Additive synthesis/Organ type waveforms.
Pianos	Piano type waveforms.

Sine

The sine waveform is pure, with no harmonics at all. It can be very effective in a Osc Mod setup where Oscillator 2 modulates the pitch of Oscillator 1.

Sound Init

Sound Init provides you with a neutral starting point for all parameters if you want to begin programming a sound from scratch.



Oscillator 2

Oscillator 2 has the same triangle, saw-tooth, pulse and sine waves as oscillator 1.



Noise

In addition, oscillator 2 can be set to produce a low pass filtered noise. The frequency/color and resonance of the noise can be adjusted with the Noise Freq and the Noise Res controls.

Keyboard Tracking (Kbt Off)

Disables the keyboard tracking of the pitch of the waveform or the noise in oscillator 2.



Fine tune - Noise Res

Fine tunes the pitch of oscillator 2 and controls the noise filter resonance if noise is selected.

Range: -50 to +50 cents

If you have an equal Osc Mix setting, and a Semi Tones setting of 0; slightly raising or lowering the fine tune value will produce a "richer" sound.



Semi Tones - Noise Freq

Semi Tones control the coarse tuning of oscillator 2, and controls the noise filter frequency when noise is selected.

Range: -60 to +60 (-/+ 5 octaves)

The red LED will be lit when the coarse tuning are set to even octaves, 12, 24, -12, -24 etc..



Oscillator Modulation (Osc Mod)

Oscillator Modulation is about having the waveform produced by oscillator 2 (or the extra sync oscillator) modulating oscillator 1. This produces a richer waveform with more harmonics from oscillator 1, the harmonics will increase as you apply more oscillator modulation.



There are two types of Oscillator Modulation: Frequency Modulation and Oscillator Sync.

Frequency Modulation (FM)

Frequency modulation generates a wider spectrum and the resulting sound is normally perceived as rawer and brighter. The harmonic content changes drastically depending on in what note range you play. By changing the frequency of oscillator 2, you change the harmonic content of oscillator 1 - not its frequency.

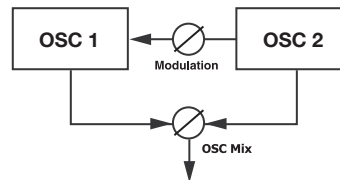

The waveform produced by oscillator 2 can be heard if you wish, by using the Osc Mix amount knob.

There are three different FM settings in the Nord Lead 4. The difference can be described as different levels of "keyboard tracking" of the amount of modulation. The harmonic content will be wider and more intense with FM 2 and wider still with FM 3, especially if you listen to notes played below C5.

Some notes can sound more or less out-of pitch using high amounts of frequency modulation; this behavior is considered to be normal.

Oscillator Sync (Sync)

When Sync is activated, an additional sync oscillator is routed to oscillator 1 (the main oscillator). Each period of this additional oscillator will restart/reset the waveform period in the main oscillator.

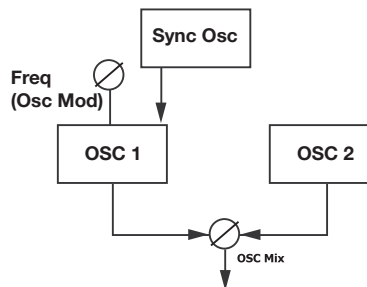

The output of the sync oscillator is not heard. The harmonic spectra of oscillator 1 is determined by the Osc Mod amount knob which sets the pitch of oscillator 1. By altering this, the harmonic content of oscillator 1's waveform is changed.

There are two types of Sync, hard and soft. In the Hard Sync setup, oscillator 1 is forced to reset with every cycle of the sync oscillator

regardless of the position of oscillators 1's waveform.

Soft Sync nudges and locks oscillator 1's frequency into the sync oscillator frequency. This creates a somewhat smoother, and in some cases, less detuned sound.

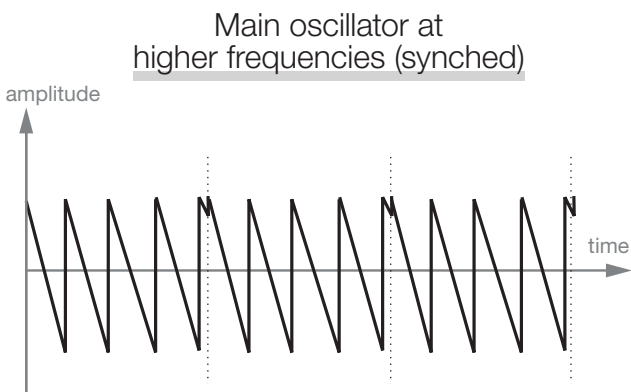
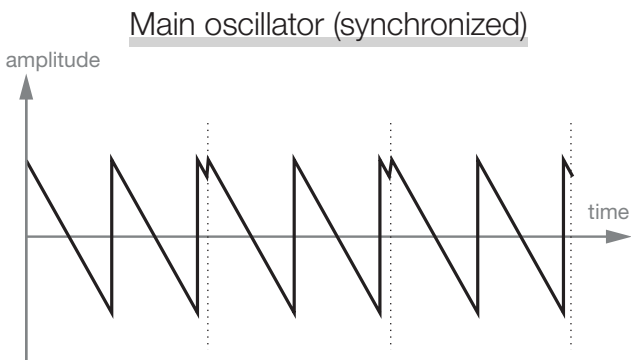
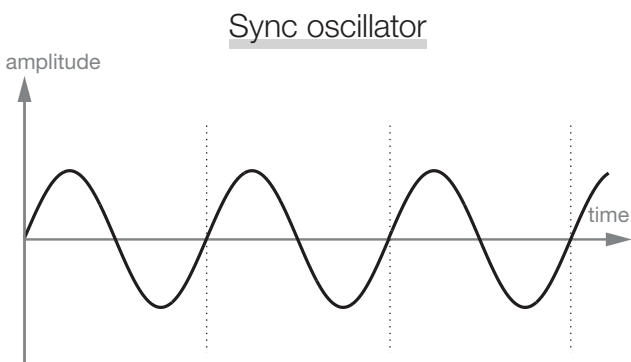
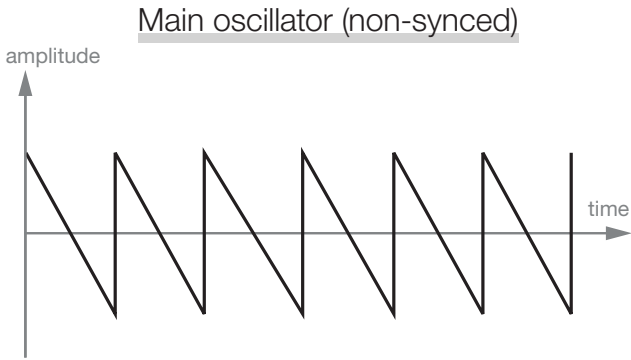

These illustrations shows what happens when a sawtooth waveform is synchronized to a sine waveform at two different sync frequencies. The sawtooth restarts its cycle every time the sine passes "zero".

Harmonic 1

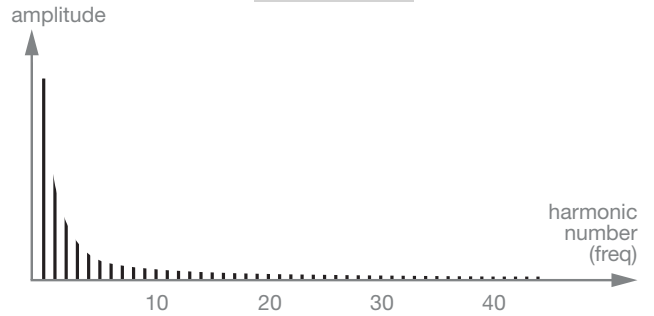

Harmonic 2

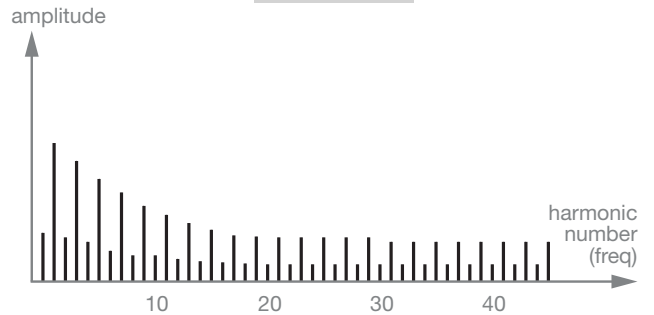

Harmonic 3

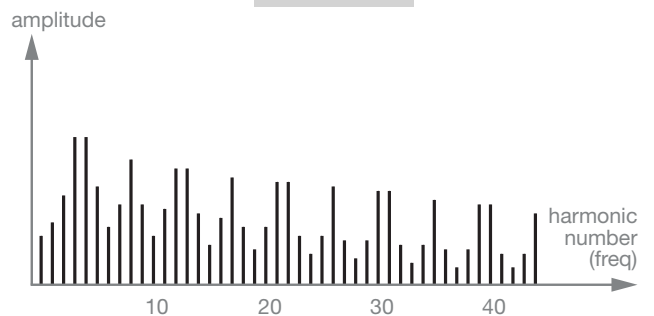

These images illustrates the harmonic content of the non-synchronized sawtooth waveform (1) compared to the synchronized sawtooth waveforms in our example (2 & 3).

Osc Mod Amount

The Amount knob controls the amount of modulation.



Type

Type activates and selects the type of oscillator modulation.

Settings: FM 1, FM 2, FM 3, H Sync, S Sync.

Panic

If notes would ever sustain indefinitely during a performance, press Panic. This will execute an internal All Notes Off command, and reset incoming MIDI CC messages.

Oscillator mix

Osc Mix

Oscillator Mix sets the balance in amplitude between oscillator 1 and oscillator 2.



Amp & Filter Envelopes

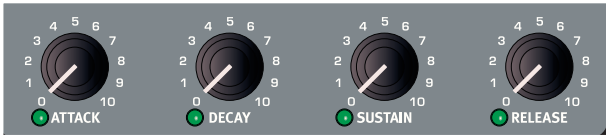

The Amp and Filter envelopes are used to control how the sound changes over time. By modulating the amplifier and/or the filter with an envelope, the sound can be given its basic “shape” and evolving tone character. In fact, the “volume shape” is one of the most important factors to how we identify the sound. By setting up a proper amplifier envelope you can make a sound “soft”, “hard”, “plucked” “static” etc.

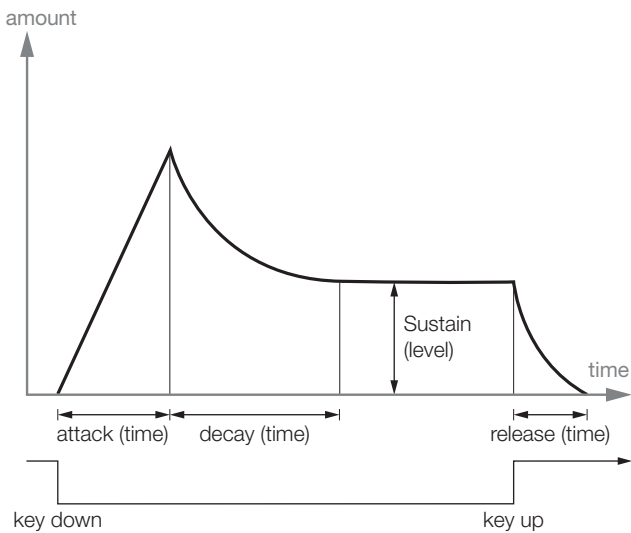

Attack

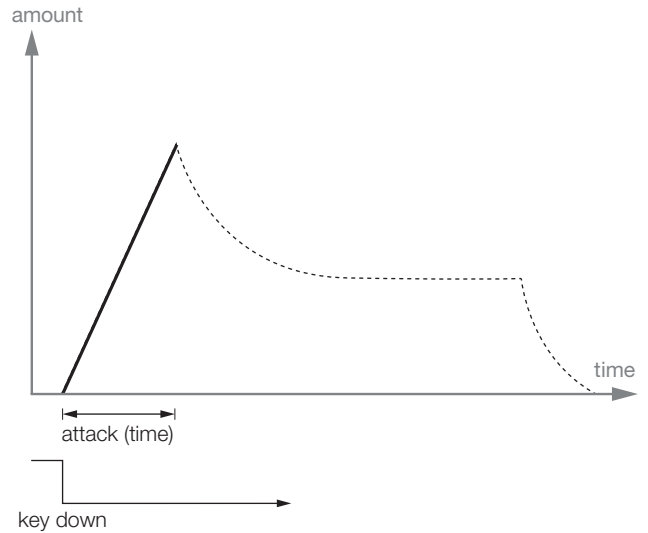

Attack is the time it will take for the envelope to go from zero to the maximum amplitude as soon as a key have been pressed.

Range: 0.5 ms to 45 s

💡 A very short attack time could produce a click in the beginning of the sound. To eliminate this, increase the attack time slightly.

Decay

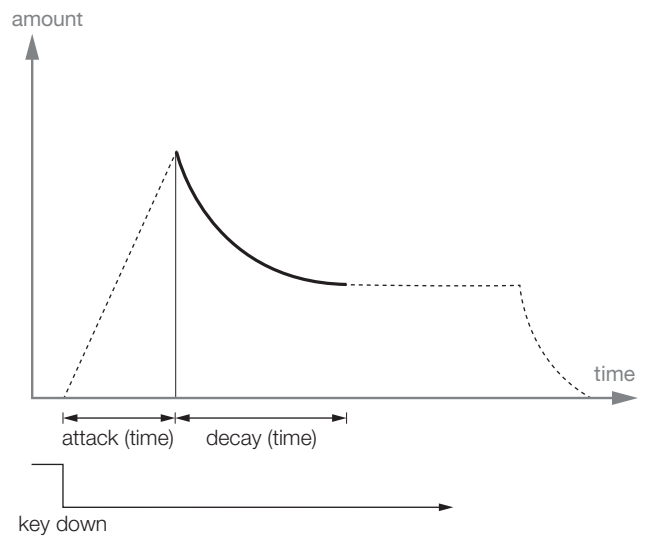

Decay is the time it takes for the envelope to drop down to the sustain level after the attack phase has been completed.

Range: 0.5 ms to 45 s

💡 If Sustain is set to the maximum level, a Decay time will have no effect since the envelope “is already” at the Sustain level.

Sustain

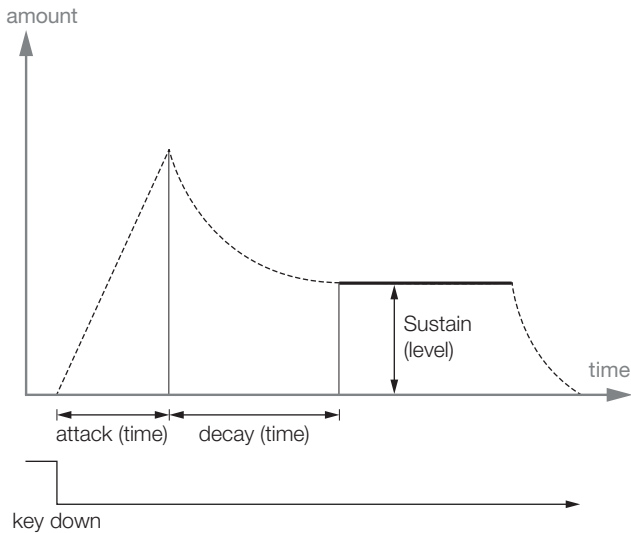

Sustain is the level the envelope will reach after the decay phase has been completed. When the envelope has decayed down to the sustain level, it will stay at this level until the key is released. With a sustain setting of zero the envelope will drop down to zero during the Decay phase of the envelope.

- The Sustain parameter is used to set a level, while Attack, Decay and Release parameters are all used to set times.

Release

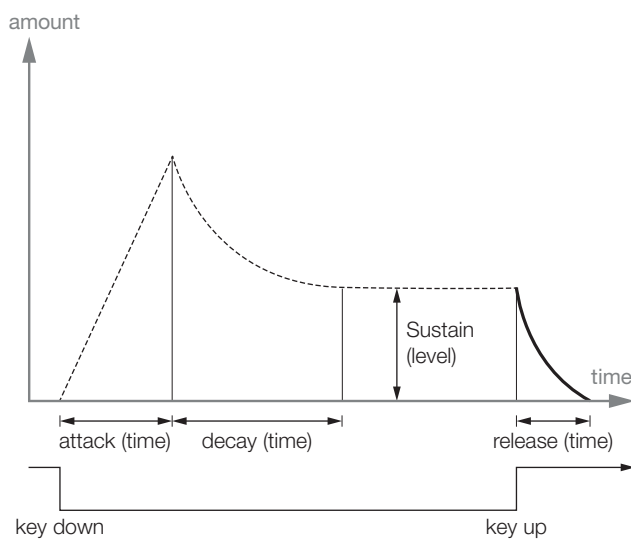

The Release phase of the envelope begins after you have released the key. This setting determines how long it should take for the envelope to drop to 0 after the key is released. The release phase may start anywhere during the envelope's other phases, it will begin as soon as a key is released.

Range: 3.0 ms to 45 s

- ⚠ A very short release time could produce a click in the end of the sound. This is a normal physical phenomenon. To eliminate such a click, increase the release time slightly.

Filter



The Filter is one of the most important components to create the overall timbre of the sound. The harmonic content that the oscillators produce can be shaped with the filter and the filter frequency response can be modulated with several functions. The Nord Lead 4 features a selection of traditional synthesizer low pass, band pass and high pass filters, a steep 48 dB low pass filter and two unique emulations of filters that are modeled from two vintage synthesizers, the Ladder M and the Ladder TB.

- ❗ The two vintage filters are not just an emulation of their characters, we have modeled the resonance, the internal distortion and the envelope characteristics of the original units as well.

The seven filters share the filter parameters: Freq controls the cutoff frequency, Resonance controls the filter resonance. Drive adds some overdrive distortion inside the actual filter and the Envelope Amount allows you to control how much the filter would be shaped by the Filter Envelope. In addition, the Envelope Amount can be controlled with velocity.

Filter Frequency (Freq)

Filter Frequency is used for setting the cutoff frequency point - where in the frequency range the filter begins to attenuate frequencies.

Range: 14 Hz - 35 kHz

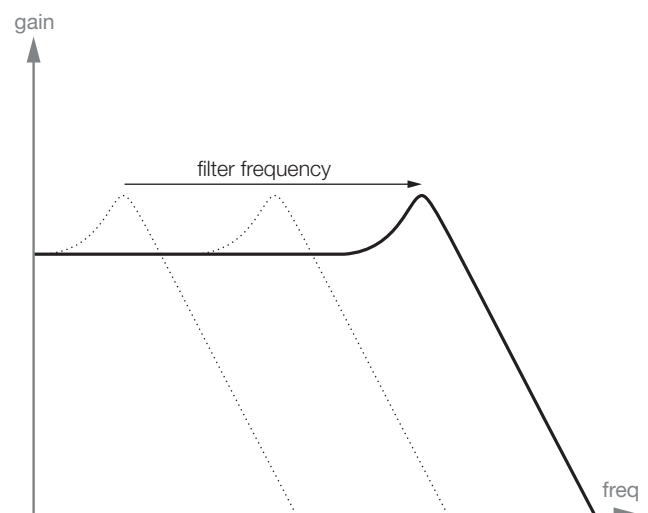

The Image above illustrates three different Filter Frequency settings using a low pass filter. The area to the right of the sloping line represents the part of the sound that is filtered out.

Filter Resonance

Filter Resonance is used to emphasize frequencies around the Filter Frequency. If you are using a low pass filter, increasing resonance will emphasize frequencies around the set Filter Frequency and de-emphasize the rest of the frequency spectrum.

Further raising the Filter Resonance will make the sound resonant to a point where the filter adds a ringing quality to the sound. Some of the filters will even start to oscillate at high resonance settings.

Drive

Drive adds a distortion inside the filter with a range that spans from gentle to quite rude.

Try the drive with high filter resonance settings.



Envelope Amount (Env Amt)

Env Amt controls how much the Filter Envelope should modulate the cutoff frequency. Positive and negative settings are possible, the envelope can open or close the filter. At the center detented 12 o'clock position, the modulation is zero.



Keyboard Tracking (KB Track)

Keyboard Tracking is used for adjusting the Filter Frequency cut-off point depending on where in the keyboard range you play.

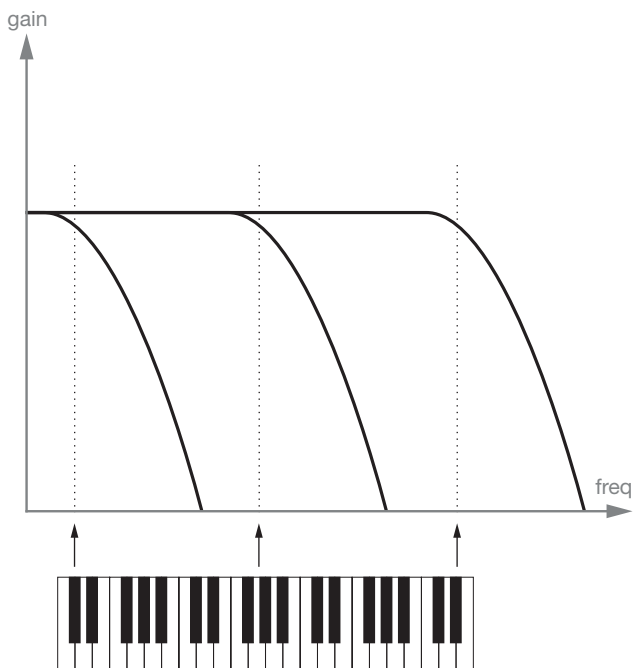
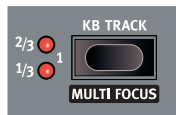

This is related to basic acoustics; if you raise the pitch of a waveform, the harmonics will also have their frequencies increased. If the filter cut-off frequency is constant, the sound will be perceived as getting duller the higher up the keyboard you play.

- With KB Track disabled, the Filter Frequency cutoff is fixed regardless of where on the keyboard you play.
- With KB Track enabled, the Filter Frequency cutoff will be higher for higher notes, and lower for lower notes. The point of reference is the key of C2.

- With KB Track at the 1/3 setting, the cutoff frequency will track the keyboard in a 1:3 relationship, play one octave higher and the cutoff frequency will move by 1/3 of an octave.

- With KB Track at the 2/3 setting, the cutoff frequency will track the keyboard in a 2:3 relationship, play one octave higher and the cutoff frequency will move by 2/3 of an octave.

- With KB Track at the maximum setting of 1, the cutoff frequency will track the keyboard in a 1:1 relationship.

Filter Type

Select one of the seven available filter types.

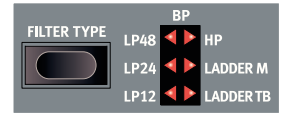

Low Pass 12, 24 & 48

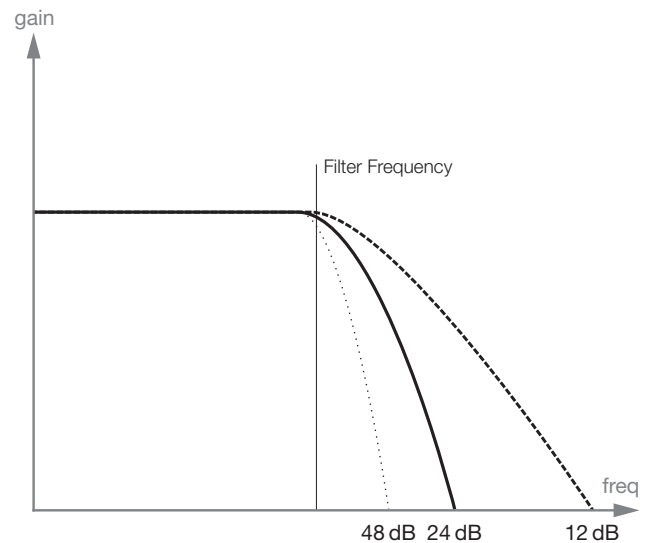

Frequencies above the filter frequency setting will be attenuated. The number indicates the slope, how steep the filter would become above the filter frequency. A 24 dB filter has a steeper slope than a 12 dB, the 48 dB has the steepest slope.

Band Pass

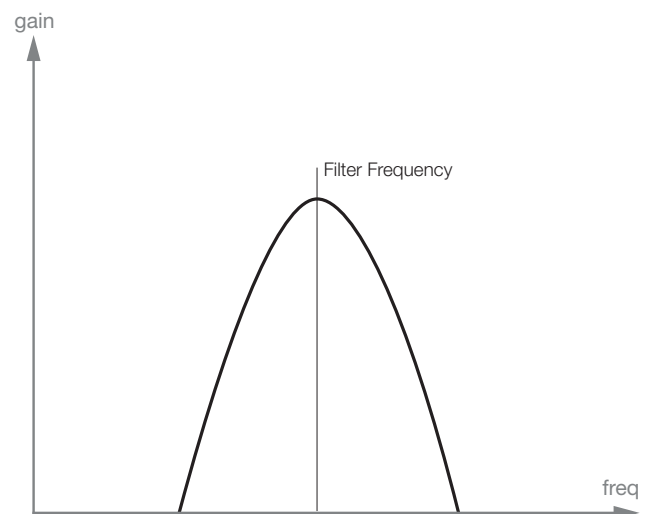

A band pass filter lets frequencies at the filter frequency to pass, while frequencies above and below the filter frequency will be attenuated.

High Pass

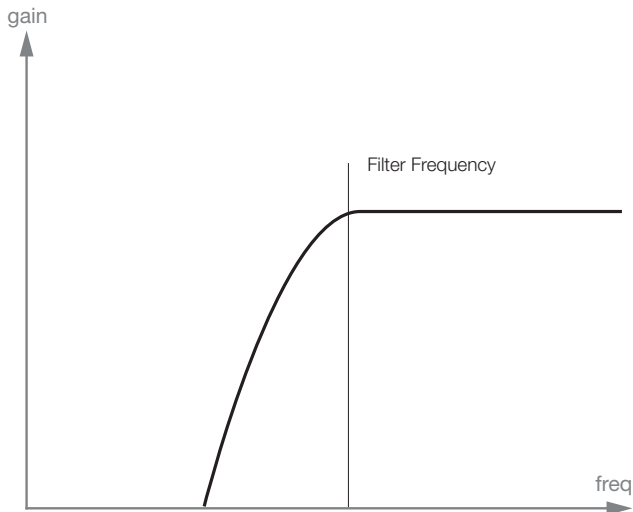

Frequencies below the filter frequency will be attenuated, frequencies above the cutoff will not be affected.

Ladder M

Ladder M is an emulation of an original transistor filter from the famous Mini. This groundbreaking and much-loved filter design was created and patented in the 1960's by Dr Robert A. Moog.

The Ladder M is a four-pole, 24 dB/octave, resonating low-pass filter. The resonance on the Ladder M is one detail that makes it stand out, leaving more of the low end of the signal than on a traditional 24 dB low-pass filter.

We have not only analyzed the frequency characteristics and the resonance, but the internal distortion and the envelope response (for both filter and amp envelopes) as well.

Ladder TB

Ladder TB is an emulation of the ladder filter from the vintage Roland TB unit from 1982. This is a low-pass, four-pole, 24 dB/octave design but it does not sound anything like the similarly spec'd Ladder M. The Ladder TB has a nice, quirky character to it and will not go into self-oscillation like the other low-pass filters, when resonance is turned up high. Another important feature in this filter is that a set resonance level will drop quite a bit if the filter frequency is lowered.

Velocity

Filter Velocity allows the filter envelope amount to be controlled with keyboard velocity.

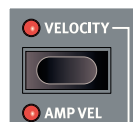

Amp Vel

Amp Velocity allows the loudness to be controlled with velocity.

Output

Level

Output Level sets the amplitude. The setting of this parameter is stored in the Program.



FX

The Nord Lead 4 has a collection of great effects that can add anything from very subtle or quite drastic changes to the sound. A unique feature in the Nord Lead 4 is the ability to modulate the FX amount with the Mod Envelope and/or LFO 2.



Crush

The bit Crusher creates a distortion by reducing the resolution of the digital audio signal. The resulting quantization noise may produce a gentle edge to the sound, or a dramatic destruction, depending on the amount.

Compressor

The compressor can reduce the dynamic range of the sound. Turn the Amount to increase the compression ratio, the output gain will be automatically compensated.

Drive

The tube-style overdrive creates that typical asymmetric soft clipping with the warm-sounding, even-order harmonics that sounds so nice on almost any sound.

Talk1, Talk2

The Talk effects can be described as how a synthesizer would sound if it was sounding from inside your mouth. The Talk effects are created by using a series of carefully implemented delay lines, and can create interesting vowel and cavity effects when modulated or when the amount control is operated.

Comb

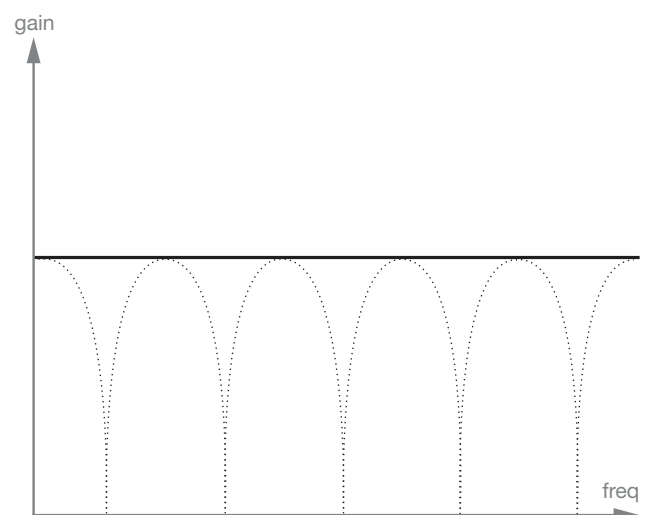

The FX Comb filter uses a delay line with feedback and a summing mixer to phase out frequencies of the original signal.

A gentle modulation of the FX amount will produce a classic phaser-type effect.

Note Trig

Press Shift + FX to trigger a note on the Nord Lead 4R. The actual note to be triggered can be selected by turning the Program Dial when holding this button combination.



Delay, Reverb

Delay or Reverb can put the finishing touches to a great synthesizer sound. Every program in the Nord Lead 4 can use either delay or reverb, even in the Performances when 4 programs can be active at the same time.

Delay

The Delay effect has 4 feedback levels, a Dry/Wet control and adjustable tempo. The Delay tempo can be set manually or synchronized to the Master Clock.

The Delay features an optional analog mode that behaves like an old school delay when changing the delay tempo on the fly.

Tempo

The Tempo knob sets the time interval between the repeats. If the Delay is synchronized to the Master Clock tempo, Tempo will set the divisions.

Range: 20 ms to 1400 ms



Division	Description
2, 4, 8, 16, 32, 64	The straight divisions range from half notes to 64ths.
4d, 8d, 16d	The "dotted" divisions will push the repeats "back" one half of the note value.
2t, 4t, 8t, 16t, 32t	The t indicates the triplet divisions.
4s, 8s, 16s,	The s indicates the swing divisions.

- i Divisions are grouped according to their perceived "tempo". This means that the "4d" will be ahead of "2t", "4s" is ahead of "4", and "4t" is after "4" etc..

Feedback

Feedback allows you to select the number of repeats. There are 4 settings to choose from, ranging from one repeat (no active LEDs), to several (both the 1 & 2 LEDs are lit).

- i Hold Shift and press the Feedback button to switch from delay to reverb functionality.

Dry/Wet

Sets the amount of the delay in the audio signal.

- i Dry/Wet is routed in a send configuration, it can for example be Morphed to "completely dry" without affecting already present delay repeats.

Sound Menu Delay Mode

The Sound Menu Delay Mode setting can be set to normal or analog. This determines if the delay should change the pitch on sounding repeats in the fashion of an analog delay, if the Delay Tempo is adjusted. When set to Normal, the pitch does not change.

On/Off

Turns the effect on or off.

Reverb

The Reverb effects simulates natural sound reflections in various acoustic environments.

Dry/Wet

The Dry/Wet knob controls the balance in amplitude between the unprocessed (dry) and processed (wet) signal.

Reverb Select

The Reverb button selects the type of reverb effect:

Setting	Description
Room	Small reverberation with room ambience and a fast decay.
Stage	Medium reverberation with stage ambience, medium decay and a bright character.
Hall	Full reverberation with a hall ambience, slow decay and a bright character.

9 Nord Sound Manager

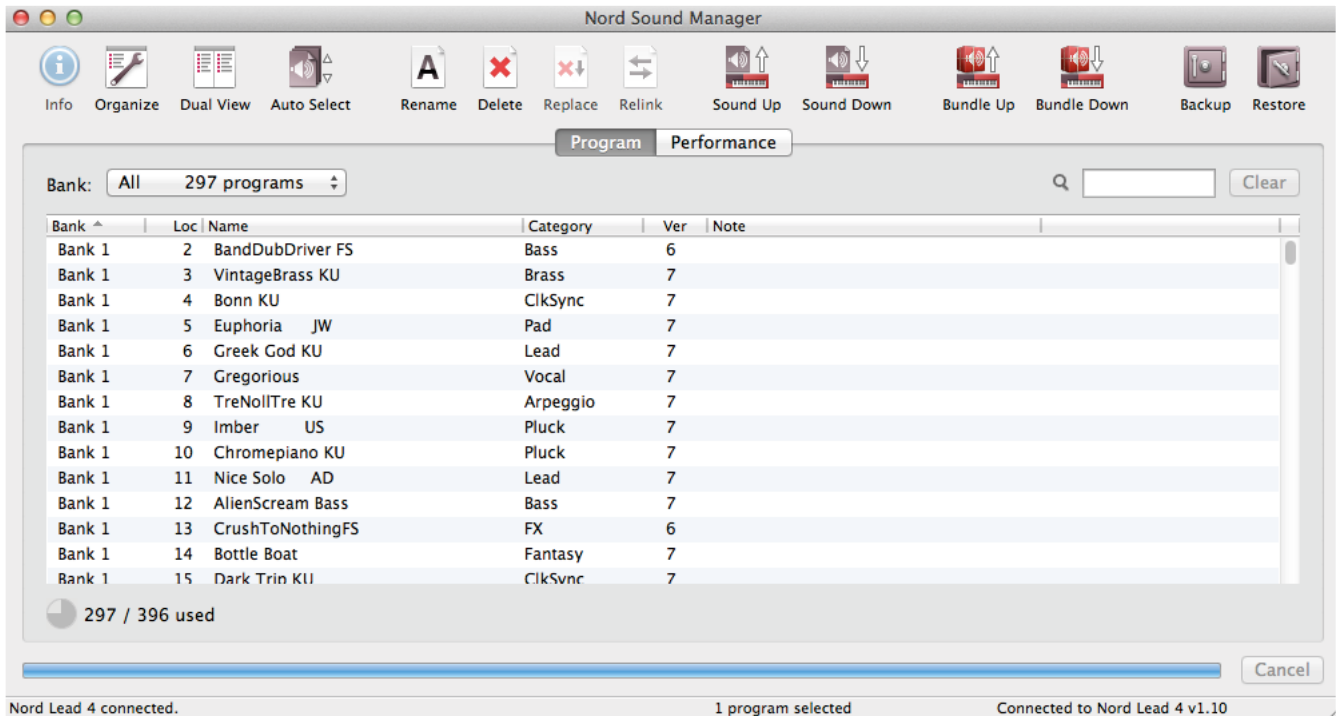

Nord Sound Manager is a free application that allows you to organize the various memory areas, the partitions in the Nord Lead 4. It is also used to download performances or programs to the Nord Lead 4 or to upload any of these items - called sounds - from the Nord Lead 4 memory to the computer hard drive. The Nord Sound Manager provides access to various methods to download the sounds to the Lead 4 and a function to backup and restore the entire Nord Lead 4 memory.

The Nord Sound Manager application and user manual is available on the www.nordkeyboards.com website, in the Download area,

System requirements

The Nord Sound Manager is compatible with computers running Mac OSX 10.4 or later, Windows XP, Vista, Windows 7 and Windows 8. If you run the Nord Sound Manager on a Windows computer, you also need a Clavia USB Driver of version 3.02 or later installed. This driver will be automatically installed with the Sound Manager. The Nord Lead 4 OS has to be v1.0 or later.

10 Synthesis Basics

Introduction

Subtractive synthesis is one of the oldest and most widely spread forms of synthesizing sounds. It is the method employed in classics as the Moog synthesizers, the Sequential Prophet-5 and 10, Arp synthesizers, most Oberheim synthesizers, the Roland Jupiter models, the TB-303 etc; the list is practically endless. Even new digital instruments such as workstations and sample playback devices employ many of the basic principles of subtractive synthesis.

With the first Nord Lead, Clavia introduced a new concept: a modern digital instrument that combined a faithful reproduction of the behavior of the old analog favorites with the convenience and stability of the newer designs. The Nord Lead 4 takes this concept even further, adding valuable new features and functionalities such as FM and Wavetables.

The purpose of this chapter is to give you a quick introduction to this world of subtractive synthesis as used in the Nord Lead 4 and its analog predecessors. If you'd like to know even more, there are number of text books or web based info that will expand on this subject.

The “building blocks”

Subtractive synthesis started its life in modular synthesizers, large cabinets housing separate electronic modules, connected via patch cords. With the advancement of technology, the functionality of many of these modules could be put onto one single circuit board. But functionality-wise, subtractive synthesizers are still built out of the same modules (or building blocks) as they were decades ago. The name “subtractive,” by the way, comes from the way a filter traditionally behaves: it subtracts harmonics from a waveform.

We will now take a closer look at these building blocks. Let's first talk about the three that actually create and process sound:

Oscillator

The Oscillator is actually the only thing in a synthesizer that actually produces any sound, (all the other modules only shape the sound from the oscillator). The oscillator is a bit like the string on a string instrument, it vibrates to create sound.

Filter

The signal from the oscillator is sent through the Filter which shapes the timbre of the sound to make it “bright”, “dull”, “thin”, etc.

Amplifier

The Amplifier shapes the volume of the sound making it “soft” or “hard”, “slow”, “plucked” or “short”.

Modulation

In addition to these main modules all synthesizers also have “modulators”, devices that can make the volume, timbre pitch and other qualities of sound vary continuously over time when you play a key.

It is these modulators that basically add animation to the sound, taking

it from a dull organ drone to a dynamic and interesting timbre. The two most common modulators are Envelopes and LFOs.

Envelopes

An envelope is used to give a sound a “shape”. If you apply an envelope to the amplifier (which controls the volume) you are able to make the sound for example slowly fade in and then fade out when you press and hold a key.

LFOs

LFO is an abbreviation for Low Frequency Oscillator. It is used for repeating variations in a sound, such as vibrato or tremolo.

Connections

The below diagram shows a basic way the NL4's modules can be interconnected (there are many more possibilities):

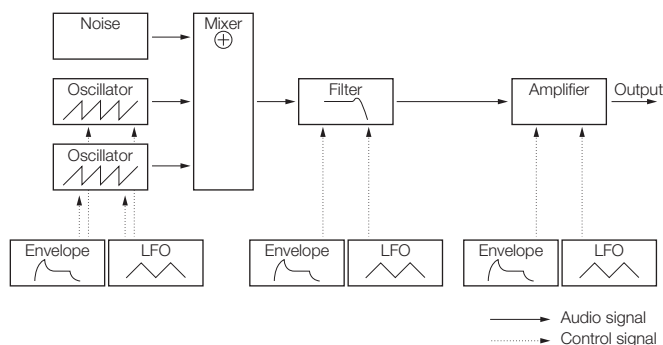

Note that the horizontal lines indicate the way the sound travels. The vertical lines indicate control signals.

The envelopes for example only modulate (control) the oscillator, filter and amplifiers; they do not affect the sound directly.

Oscillators and waveforms

The two basic qualities of an oscillator are its waveform and its pitch.

Pitch

The picture of the sawtooth on the Nord Lead 4 front panel displays a sawtooth during one period of sound. During this time, the wave raises gradually up to maximum level and then instantly drops back to minimum level.

The length of the period determines the pitch (frequency) of the sound. The shorter the period, the higher the pitch.

If you for example make the oscillator play at a frequency of 440Hz, there will be 440 periods of identical Sawtooth waves generated per second.

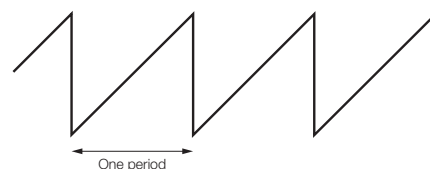

Normally there are three ways to change the frequency of an oscillator:

- By making settings on the front panel. On the Nord Lead 4 for example, you have an “Oct Shift” that will affect both oscillators and separate Semitone and Fine Tune adjustments for Oscillator 2.
- By playing the keyboard. The keyboard is of course connected to the oscillator, pressing different keys produces different pitches.
- By Modulation. Modulation allows you to make the pitch vary “automatically.” The most common example is to use an LFO to make pitch go up and down, to create a vibrato. But you can also put the pitch under envelope control, or make the pitch vary with your striking force (velocity).

Waveform

The waveform of the oscillator affects its harmonic content and thereby its “sound quality” (timbre). The three most common waveforms are sawtooth, pulse wave and triangle.

Looking at the shape of a waveform tells very little about how it sounds. Instead, there’s a better way to draw or visualize it, called a spectrum. Let’s introduce some quick theory:

Mathematically, all periodic waveforms can be considered as built from a number of harmonics added together.

Each of the harmonics represents a sine wave, the purest and simplest waveform there is (a sine wave has no harmonics at all). In other words, if you add a number of sine waves together, each one with its own pitch (frequency) and volume (amplitude), then you can build any waveform you like.

The lowest harmonic is called the fundamental. The fundamental determines the basic pitch of the sound.

If the fundamental has a frequency of 440Hz, we will perceive the entire sound as having a pitch of 440Hz.

Other harmonics are then added to the fundamental, called overtones. The first overtone appears at a frequency twice the fundamental (in our example 880 Hz). The next harmonic appears at a frequency three times the fundamental (in our example 1320Hz) and so on.

In a spectral display of a waveform you can see the frequency (pitch) of each harmonic and its amplitude (level). This is done by drawing each harmonic as a line raising up from a horizontal scale.

Each line’s position on this scale indicates the harmonic’s frequency. The line furthest to the left is the fundamental, the next is the first harmonic etc. To make life easier, one usually doesn’t label the horizontal scale with frequency in Hz, but rather with the number of the harmonic.

The height of each line represents the amplitude of each harmonic.

If you understand the principle, you also understand that if the harmonics with high numbers have a high amplitude, the sound will be perceived as bright.

Let’s take a look at some common waveforms and their spectra.

In the illustrations below, only some of the first harmonics are displayed. In reality, waveforms like these have an infinite amount of harmonics.

Sawtooth

The Sawtooth wave has a simple spectrum. All harmonics are present in the wave, in proportional values.

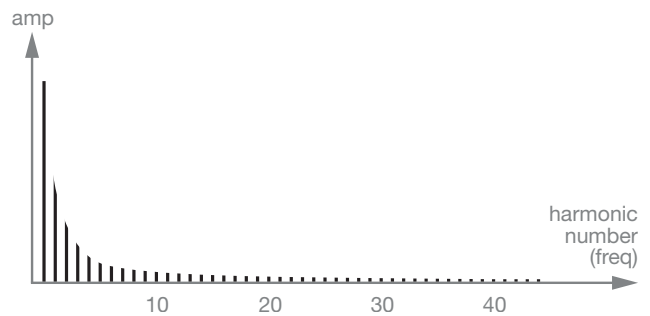
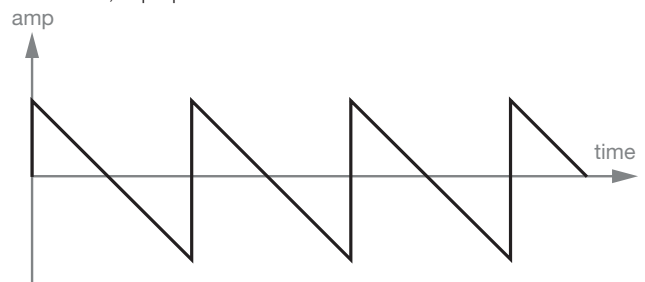

As you can see, the high harmonics have a fairly high amplitude, which makes this waveform sound bright.

Triangle

The triangle wave does not have very strong harmonics. Furthermore they only appear at odd harmonic numbers.

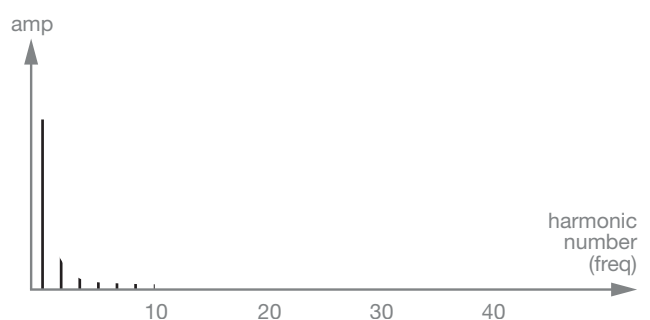
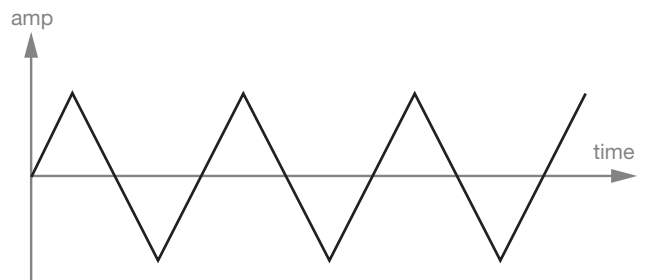

The first fact makes the tone pure, a bit like a flute, and the second fact gives the sound a slightly “hollow” character.

Pulse wave

The pulse wave is slightly more complicated, because it is not one waveform, it is many different ones. A pulse wave is a waveform that during one period jumps once between full positive amplitude and full negative and then back. The thing that can be varied is where within the period you jump from maximum to minimum amplitude. Let’s look at two examples.

In the first example, the jump happens 1% in from the beginning of the period. This is referred to as a pulse wave with a 1% pulse width (sometimes called duty cycle).

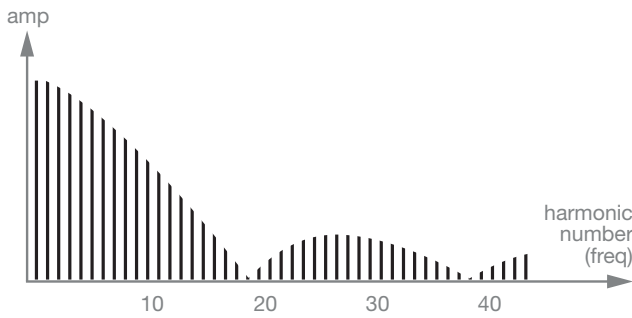
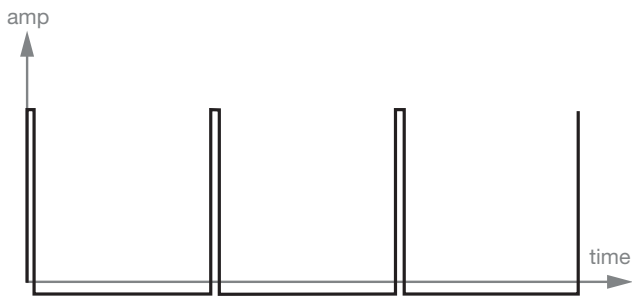

The second example has a pulse width of 50%.

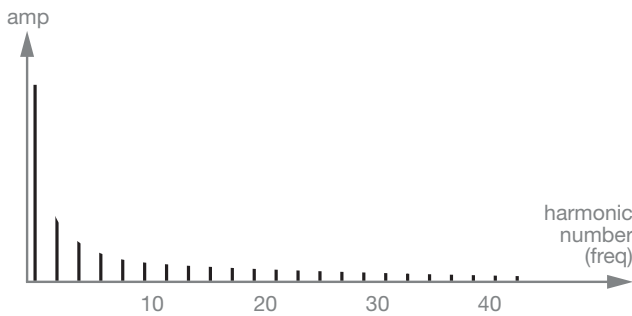
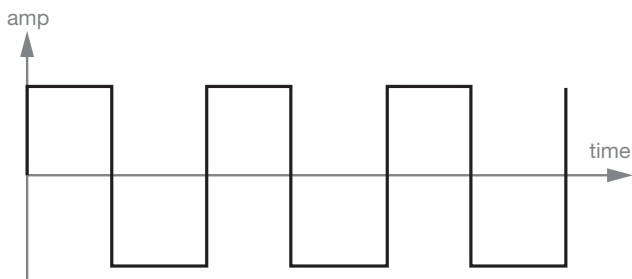

This second example is a special case of the pulse wave, called a square wave, and this has one peculiarity, it only contains odd number harmonics, which gives it a "hollow" quality.

On many synthesizers (including the Nord Lead 4) the pulse width can be adjusted, to set the timbre of the pulse wave. The more narrow the pulse width, the more "thin" the sound will be.

You can also have the pulse width vary continuously, for example from an LFO or envelope. This is referred to as pulse width modulation. Modulating pulse widths from an LFO creates a rich, chorus-like effect often used in "string" sounds.

About in-harmonic spectra

We have only discussed spectra where the overtones appear at perfect harmonics so far. While this is true for the basic waveforms discussed above, it is definitely not true for all sound. If, for example, you use the frequency modulation (FM) capabilities in the Nord Lead 4, with

the two oscillators set to an "unusual" interval (not octaves or fifths, for example), you will get a spectrum where the overtones appear at frequencies somewhere between the perfect harmonics. This results in an in-harmonic sound, which often sounds "metallic".

Sync

On some synthesizers, one oscillator can be synchronized to another. If you for example synchronize oscillator 2 to oscillator 1, oscillator 2 will start over with a new period of the waveform, each time oscillator 1 does so. If oscillator 2 then has a higher frequency than 1, it will get a complex waveform that depends both on its own pitch and on that of the other oscillator.

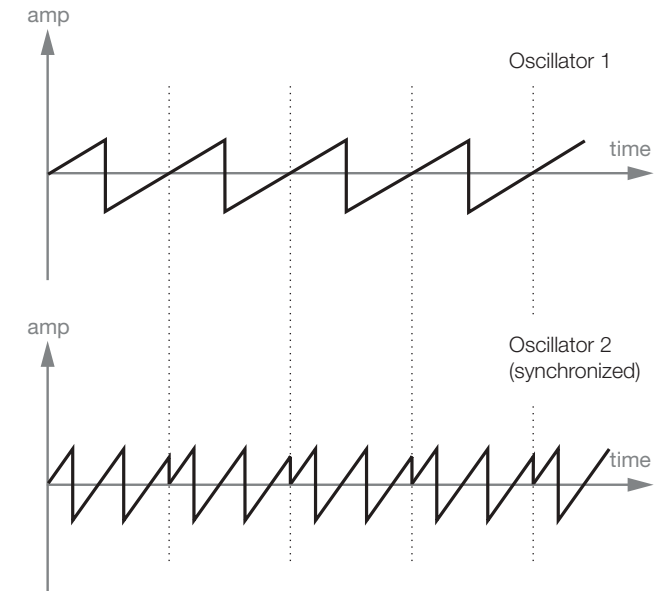

When sync is applied, the basic pitch of Oscillator 2 is locked to that of Oscillator 1. If you change the pitch of Oscillator 1 you will affect the basic pitch of both oscillators. Furthermore, when you vary the pitch of the synchronized oscillator (Oscillator 2), this will be perceived as a change in timbre, rather than in pitch.

This leads to a spectrum with deep resonances at Osc2's harmonics, like this:

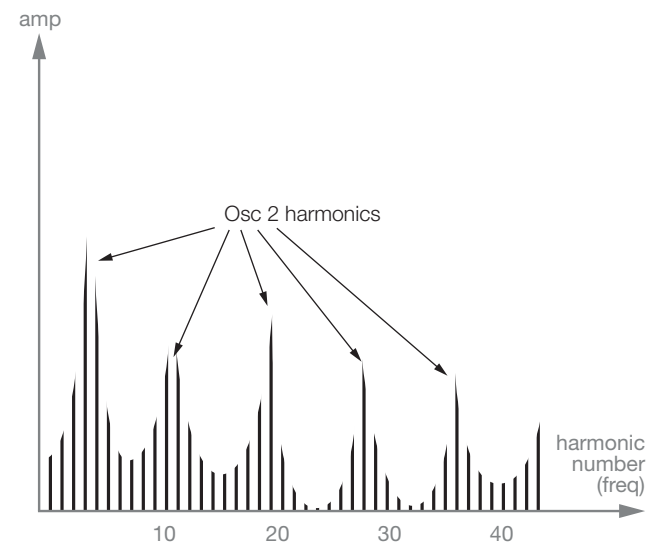

If you go even further and let the pitch of the synchronized oscillator vary continuously, for example from an LFO or envelope, you will change the harmonic content of the sound in an interesting and very characteristic way.

Filter

The filter in a synthesizer is used to remove or emphasize frequencies in a spectrum. A filter is a bit like an amplifier (a volume control) that is applied differently to different parts of the spectrum. For example, a filter might make low frequencies louder, while at the same time making high frequencies weaker. Applying such a filter would make a sound have more bass and less treble.

Let's imagine a sound with a spectrum where all harmonics are available at full level. It would look like this:

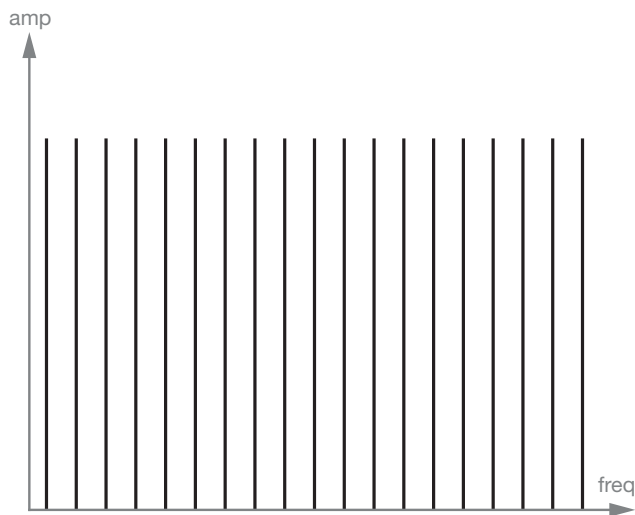

Let's now pass this spectrum through a lowpass filter (this type of filter is discussed in more detail below).

The filter has a characteristic, which can be drawn as a curve:

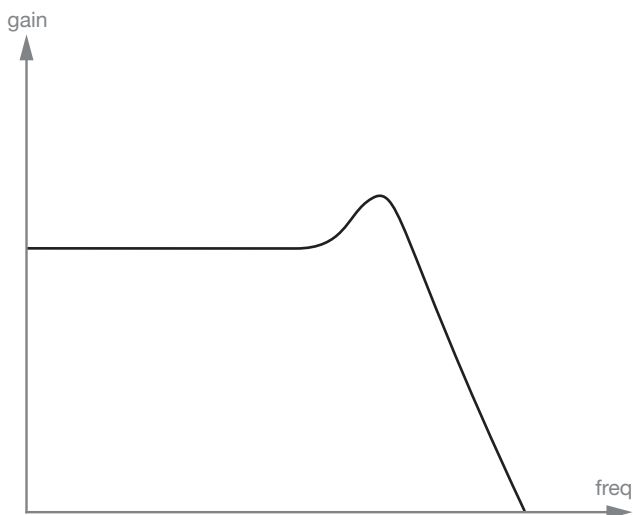

As you can see the curve is flat in the low register (which means it doesn't affect this part of the spectrum at all) and then, at a certain point, gradually starts falling.

When applied to the example wave, this filter cuts away some of the high frequency material in the wave, like this:

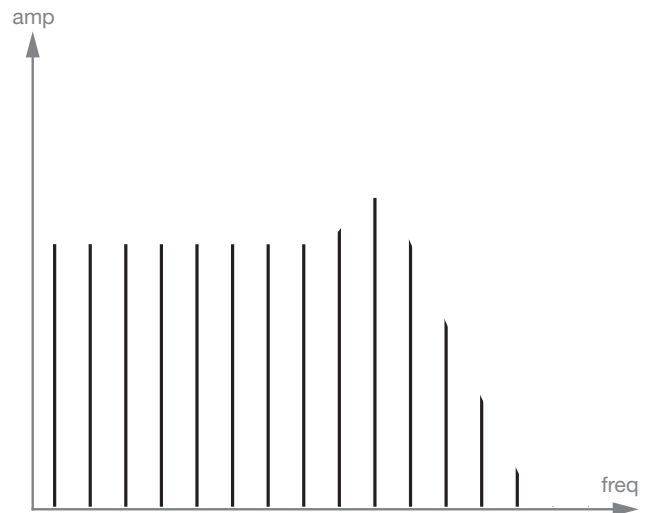

Filter types

There are many types of filters, all with their different purposes. Let's discuss the three most common ones that are found in the Nord Lead 4. As you may already have noticed, the filters are explained in detail in the Panel Reference chapter

Lowpass filter

The lowpass filter dampens high frequencies and allows low frequencies to pass through unaffected, as in the example above. It is the most common synthesizer filter, since it can be used to "round off" the sharp sound of sawtooth waves and pulse waves.

Highpass filter

This is the opposite of the lowpass filter. It allows the high frequencies of the sound to pass through and cuts off the low frequencies. This removes "bass" from a sound, without affecting the high end.

Bandpass filter

This allows frequencies in a certain range of the spectrum (the band) to pass through while dampening frequencies both below and above this range. This accentuates the mid-range of a sound.

Slope

Filters of one and the same type (lowpass, highpass etc) can have different characteristics. One of the factors determining the exact filter curve is the roll-off, which is measured in dB/Octave (“decibels per octave”) or poles. The simplest possible filter has a roll-off of 6dB/octave, which is referred to as “1 pole”.

The next step up is 12dB (2 poles), 18db (3 poles) etc.

The most common synth filters are the 12dB and 24dB lowpass filters. The difference between the two can be studied in the graph below. The 12dB filter let’s more of the high frequency pass through which gives the sound a brighter and “buzzer” character than the 24dB filter does.

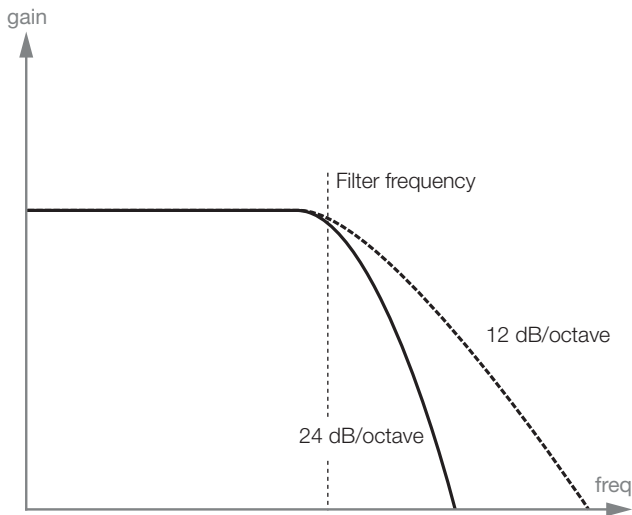

In the Nord Lead 4, the lowpass filter can be switched between 12, 24 and 48 dB modes.

Cutoff frequency

The most important parameter for a filter is its cutoff frequency, which is the setting that determines where in the frequency material it should start cutting. If the cutoff frequency in a low pass filter is set to a very low value, only the lowest harmonics (the bass) will pass through. If you raise the cutoff all the way up, all frequencies will be let through, as the figure below illustrates.

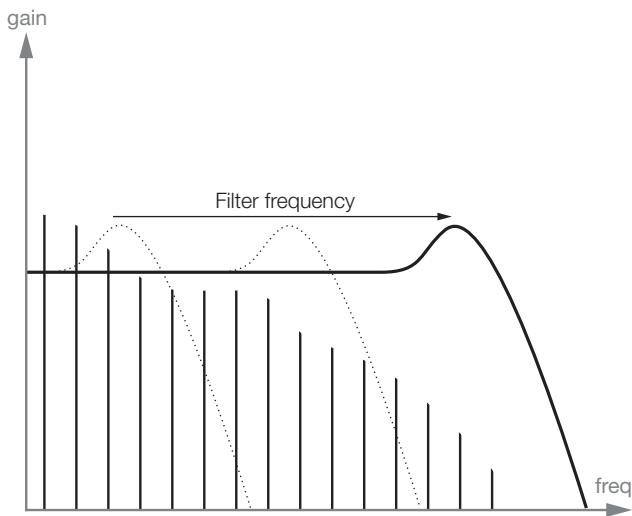

Changing the cutoff frequency is often referred to as “sweeping the filter”. This is probably one of the most important ways of shaping the timbre of a synthesizer sound. By using an envelope you can for example have a high cutoff at the beginning of a sound which is then gradually lowered (the filter “closes” as the sound decays). This would emulate the way most plucked string sound (piano, guitar etc) behave; the amplitude of the harmonics decreases as the sound decays.

Keyboard tracking

When you play different pitches, the oscillators produce different frequencies. This means that the overtones in the waveform appear at different frequencies. The cutoff frequency of the filter however, is fixed.

This means that different overtones will be cut off at different pitches. To be more precise, the further up the keyboard you play, the muddier the sound will be.

To remedy this problem many synthesizers have a parameter called Filter Keyboard Tracking. When this is activated, the filter Cutoff Frequency varies with which key you play, just as the oscillator frequency does. This ensures a constant harmonic spectrum for all keys.

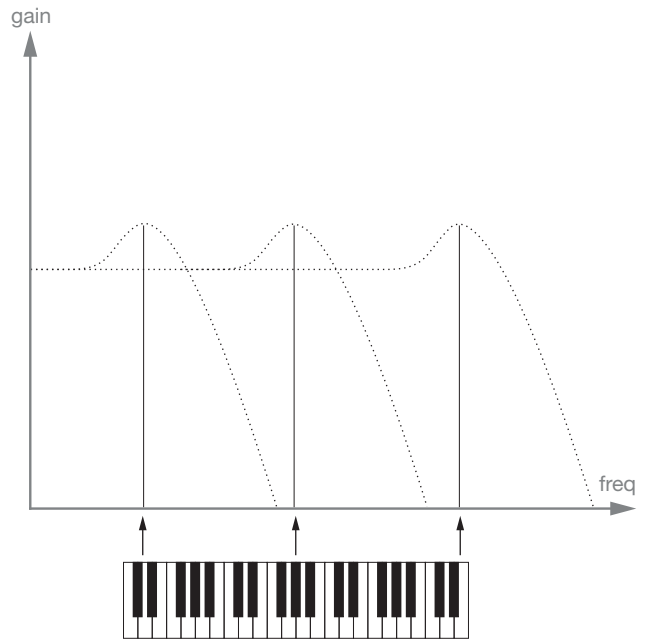

Resonance

Resonance in a filter is created by increasing the routing of the output from the filter to its own input. The amount of feedback is then controlled with a Resonance function on the front panel of the instrument.

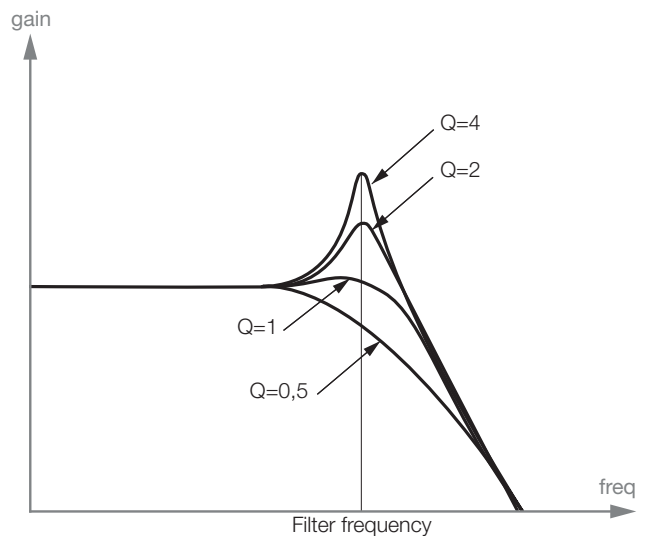

When you apply resonance, the frequencies just around the cutoff point of the filter will be emphasized (louder). As you increase the resonance further and further, the filter will start to behave more and more like a bandpass filter, where only the frequencies around the cutoff point are let through. The filter will start to “ring”, which means it almost sounds like it is adding frequencies to the sound.

If the Resonance is then raised even further (on some synthesizers) the filter will start to self-oscillate, that is produce sound of its own, just like an oscillator.

High resonance values are also visible in the waveform. They appear as a “superimposed” waveform with a frequency equivalent to the filter’s cutoff frequency.

If you add resonance to a sound and then vary the Cutoff frequency (for example with an envelope) you will get a very typical synthesizer sound.

Amplifier

An amplifier is most often used at the final stage of a synthesizer signal chain, to control volume. By modulating the amplifier with an envelope, the sound can be given its basic “shape”. In fact, the “volume shape” is one of the most important factors to how we identify the sound. By setting up a proper volume envelope you can make a sound “soft”, “hard”, “plucked” “static” etc.

Envelopes

ADSR-envelope

Envelopes are used to modulate pitch, amplitude, filter cutoff and other parameters in a sound. This is used to give the sound a varying character from the moment the key is pressed to the moment it is released.

The classic synthesizer envelope has four parameters, Attack, Decay, Sustain and Release, and is therefore often referred to as an “ADSR-envelope”.

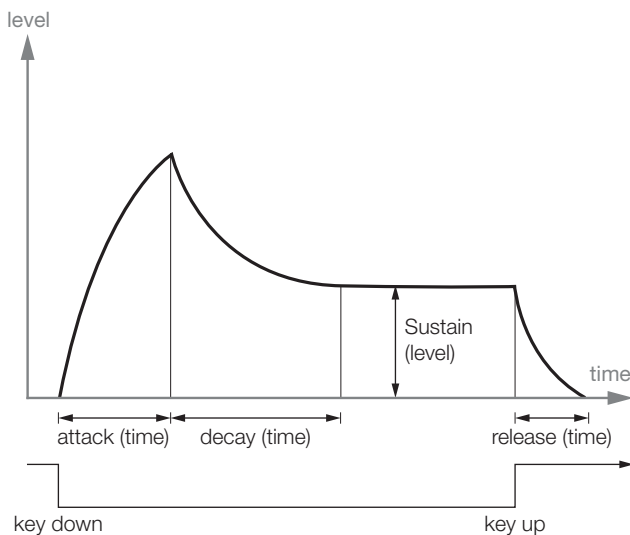

When you press a key, the envelope is triggered. This means it starts from zero and rises to the maximum level.

The Attack setting defines how much time it will take for the level to go from zero to max. If the Attack time is set to “0”, the envelope will instantly reach full level. If the attack time is higher it will take longer.

If you for example have an envelope controlling volume, raising the attack will give the sound a “softer” character. If you have the envelope routed to the filter, it might give the sound a “wah” type of start.

After the envelope has reached full level, it starts to fall back again. The Decay parameter defines how much time it takes for the level to fall from the maximum to the Sustain level.

The level of the envelope does not necessarily have to fall all the way back to zero level at the end of the Decay. Instead, the ADSR-envelope has a Sustain setting used to determine the level the envelope should rest at, after the Decay.

If you for example want to create a flute sound, you would have a fairly high Sustain setting on your amplifier envelope, since a flute tone basically stays at a steady level for as long as you blow it. On the other hand, for a piano sound, you would want a Sustain level of “0”, since a piano sound decays to silence if you hold the key long enough.

Please note that the Sustain parameter represents a level, but all other envelope parameters represent times.

As described above, the envelope stays at the Sustain level until the key is released. It then falls back to zero level. The time it should take for this to happen is set with the Release parameter, which works just as the Decay, but it is not applied until you lift your finger off the keys.

- If you set Sustain to full level, the Decay setting is of no importance since the volume of the sound is never lowered until the key is released:
- If you set Sustain to 0, the sound will become silent after the Decay phase is finished. With short Attacks moderate Decay times, this can be used to simulate the behavior of a plucked string instrument (guitar, piano etc) where the sound always decays to silence after a while:
- If you release a key before the envelope has reach its sustain, it will immediately “jump” to the Release.

The effect of this can be studied in the illustration below:

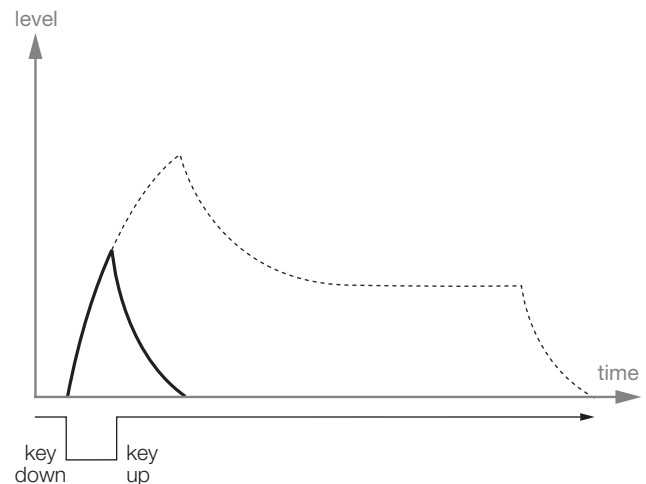

Often envelope amounts can be made to vary with how hard you play the keys. This is used to make a sound vary with your playing style, for example to make the sound brighter (filter envelope) or louder (amplifier envelope).

AD-envelope

A simpler form of envelope has Attack and Decay parameters only, and is therefore called an AD-envelope. A version of this has attack and release parameter, an AR-envelope.

In effect, the AD-envelope behaves like an ADSR-envelope with Sustain set to 0 (see the picture at the top of this page). This type of envelope, often with amount and inversion controls, is suitable when you want to affect the start of the sound only.

On the Nord Lead 4, the Modulation Envelope can be set as either an AD or an AR type.

LFOs

An LFO is an oscillator, just like the ones that produce the sound in a synthesizer, but with two main differences:

- The LFO produces very low frequencies, often below the hearing range.
- The LFO is not used to produce sound, instead it is connected to other modules to provide modulation of parameters. If you for example route an LFO to pitch, you get a vibrato. If you route it to the amplifier you get a tremolo.

The three basic parameters for an LFO are Waveform, Rate (frequency) and Amount:

- The waveform determines the type of modulation, for example “regular” (triangle or sine), ramp (sawtooth) or random.
- The Rate determines the speed of the modulation.
- The Amount controls the degree to which the LFO affects its destination.

11 The Menus

Any settings that you change in the System, MIDI, Sound or Mutator menu will take immediate effect on a global basis, and will be stored until you change them the next time. Enter the menus by pressing and holding Shift and the System, MIDI, Sound or Mutator button (Slot A - D buttons), the A-D LED above the buttons will start blinking. Select a function by turning the Program Dial and change the setting by holding Shift and turn the Program Dial at the same time. Exit the menus by pressing a second time on the Slot button.

System Menu

1 - Memory Protect – On, Off

The Memory Protect setting determines if Programs and Performance can be stored to the Nord Lead 4 memory or not. The setting is On when the Nord Lead 4 leaves the factory.

- ❗ *System, MIDI and Sound menu settings are not protected.*

Range: On (default), off

2 - Transpose

This setting can transpose the pitch of the Nord Lead 4 up or down in semitone steps.

- ❗ *The MIDI output will not be transposed.*

Range: +/- 6 semitones (default = 0).

3 - Fine Tune

This setting fine tunes the pitch of the Nord Lead 4.

Range: +/- 50 cent (default = 0).

4 - Sustain Pedal Polarity

Change the polarity of a connected sustain pedal, in case the functionality of the pedal is reversed. The Auto setting will determine what polarity a connected pedal has.

Range: Auto (default), CL - Close, OP - Open.

5 - Ctrl Pedal Type

Different models of control pedals have different specifications (resistance, offset and linearity). The most commonly used pedals are pre-configured in the Nord Lead 4, select the type you use.

Range: R5 (Roland EV-5, default), R7 (Roland EV-7), Y7 (Yamaha FC-7), K0 (Korg EXP-2 & XVP-10), Ft (Fatar & Studiologic VP/25)

6 - Ctrl Pedal Mode

A connected Control pedal can be used to control the Nord Lead 4 volume or as a Continuous Morph Controller.

Range: c1 Volume (default), c2 Wheel Morph.

7 - Ctrl Pedal Gain

Add some gain to the output of a connected Control pedal if it does not reach the maximum level. Operating a connected control pedal will display the output level from 0 to 100.

Range: 1 - 10.

8 - Impulse Morph Protect

This is a protection feature for the Impulse Morphs. When this is On, Impulse Morphs have to be locked for any adjustments to stick or new Morph settings will be discarded as soon as you release the Impulse button(s).

Clear Impulse Morph is disabled when Impulse Morph Protect is On, except if the Morph is locked.

Range: On, Off

A B C D - Slot Output Routing

Route the Slots to the audio outputs of the Nord Lead 4. Slots can be routed to output pairs (1-2 and 3-4), or single outputs.

- ⚠ *Outputs 1 & 2 are routed to the headphones.*

Range: 12 (default), 34, 1, 2, 3, 4.

MIDI Menu

G - Global Channel

The Global MIDI Channel transmits all keyboard, pedal and panel actions. It can also be used as a receiving channel.

Range: 1 ~ 16, Off

A, B, C, D - Slot Channel

Set individual MIDI Channels for the Slots when they should respond to MIDI events on certain incoming MIDI Channels.

Range: 1 ~ 16, Off

t - Soft Thru Channel

Incoming MIDI note on/off messages that are received at either the 5-pin or the USB MIDI on the Soft Thru Channel, will be re-routed to the 5-pin MIDI OUT connector.

Range: 1 ~ 16, Off

1 - MIDI Interface

Choose to use the MIDI interface on the 5-pin DIN connectors or the USB-MIDI functionality.

Range: P - 5-PIN DIN MIDI ports, U - USB-MIDI (default)

2 - Local Control

Local disables or enables the connection between the keyboard and panel and the actual Lead 4 synthesizer. Local On is the default setting. Local Off is useful when an external sequencer is used and the keyboard and panel is only used to transmit MIDI, which the sequencer then routes back to the synthesizer.

Range: On (default), Off

- ❗ *Local defaults back to On every time the Nord Lead 4 is powered on.*

3 - Control Change (CC) Mode

Control Change Mode specifies how the front panel's knobs and buttons are handled in the MIDI communication with MIDI Control Change messages. The options are either send or receive, or both, or if these messages should be ignored.

Range: Sr (send & receive - default), r (receive only), S (send only), Off

4 - Program Change Mode

Program Change Mode specifies how the Nord Lead 4 handles MIDI Program Change messages.

Range: Sr (send & receive - default), r (receive only), S (send only), Off

5 - Pitch Bend Mode

Pitch Bend Mode specifies how the Nord Lead 4 handles the Pitch Bend stick and incoming pitch bend MIDI messages.

Range: Sr (send & receive - default), r (receive only), S (send only), Off

6 - Send CC

Dump all Program parameters of the currently active Program as MIDI Control Change messages. Press Execute to begin the transmission.

7 - Dump One

Dump One makes a MIDI System Exclusive transmission of all the parameters of the currently active Program or Performance. Press Execute to begin the transmission.

8 - Dump Program Bank

Dump Program Bank makes a MIDI System Exclusive transmission of all the parameters, for all of the 99 Programs or Performances in the current Bank. Press Execute to begin the transmission.

In the MIDI chapter on page 47, there is a description on how the Nord Lead 4 receives a Sys Ex dump.

Sound Menu

1 - Mst Clk Kbd Sync

Master Clock Keyboard Sync On will reset the Master Clock when a key is played. The Soft option is a more gentle approach, depending on when in the beat, the key is played.

Range: Off, Soft (default), On

2 - Delay Mode

Delay Mode Analog will change the pitch on sounding repeats, when the Tempo is adjusted with the Delay Tempo knob. When set to Normal, the pitch will not change.

Range: Normal, Analog (default)

3 - Vibrato Rate

The rate of the Vibrato.

Range: 4.00 - 8.00 Hz (Default 4.80 Hz)

4 - Vibrato Amount

The amount of the Vibrato when the delayed vibrato modes are used.

Range: 0 - 50 cent (Default value is 10 cent)

5 - Impulse Morph Merge

Impulse Morph Merge will merge Morph settings that have been made to Impulse Morphs 1, 2 and 3, to create Impulse Morphs 4 to 7. Press Execute to merge.

 *If any of the Impulse Morphs 1, 2 and/or 3 share a parameter, this parameter will not be included in the merged results.*

Mutator

The Mutator is an automatic program generator with three different methods of generating programs. The A and B process will use the current Program as a starting point. The strength setting (1-5) will determine how "different" the result will be. The differences between A and B will be applied if you execute another Mutation after the first:

The A process will look again at the current Program as the origin and create another mutation. Use this process to create new variations based on one existing sound.

The B process will instead use the result of the first mutation and interpolate an evolution. Use this process to create a set of variations that gradually progress from one existing sound to another.

The Rnd option is a random process that does not consider any current or previous Programs. Use this to create completely random sound variations.

 *Hold Copy and turn the Dial counter clockwise to undo the last executions.*

Range: A1-A5, b1-b5, RnD

12 MIDI

Nord Lead 4 MIDI operation

The Nord Lead 4 is designed to be very flexible in a MIDI setup. You can use it as a keyboard to control its internal sounds and other hardware or software sound sources. It can also be used as a set of individual sound engines to be played/controlled by external MIDI units such as a sequencer.

There are two fundamental methods of operation when using the Nord Lead 4 in a MIDI setup. You can use the Global MIDI Channel or individual Slot MIDI Channels. These methods differs a little bit in their flexibility and in what you can achieve.

Lead 4	MIDI IN	MIDI OUT
Global MIDI	✓	✓
Slot MIDI	✓	

Keys you play on a Nord Lead 4 keyboard, and any tweaks that you do on the Lead 4 panel will generate MIDI messages on the Global Channel.

A Slot MIDI Channel is only receiving MIDI messages, with one exception: Program Change messages will be transmitted if you change programs for the Slot that is in focus.

- ❗ *Whenever the text in this manual refers to a “keyboard”, the meaning in the description is also relevant for a external MIDI controller, if you are for example using a Nord Lead 4R.*

MIDI Settings

MIDI Channel selections, settings on how the Lead 4 should handle Program Change, Pitch Bend, Control Change messages and other MIDI related settings are made in the MIDI Menu.

Global MIDI Channel

By using the Global MIDI Channel, all MIDI notes and Control Change messages can be transmitted and/or received on a single MIDI channel.

MIDI that enters the Nord Lead 4 on the Global MIDI channel will play all the Slots that are active. If a Performance includes layers and/or splits, or actions with the Morph controls, those aspects will be reproduced in the same way as if you played on the keyboard itself.

Slot MIDI Channels

By using the individual Slot MIDI Channels in the Nord Lead 4, you have individual control of the Slots, for notes as well as for parameters. This can for example be used as a multitimbral setup, controlling 4 individual sound sources from a sequencer.

A Slot does not have to be active in a Performance, it will always respond to incoming MIDI on its MIDI Channel. This makes it possible to control selected Slots from the keyboard, and other Slots from other external sources.

Sequencing: Global MIDI Channel

Connect the Nord Lead USB connection (or the 5-pin MIDI In and Out) to a computer/MIDI interface/sequencer. Set the sequencer track to all Channels or MIDI Channel 1, which is the default Global MIDI channel in the Nord Lead 4.

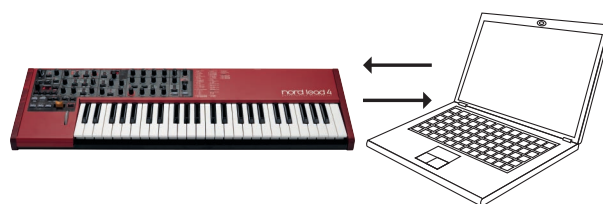

Play on the keyboard and record the performance. Any controllers that you use – Continuous Morphs, Impulse Morphs, pedals etc. – will also be transmitted as MIDI messages.

Recording parameter changes

There are more parameters available in the Nord Lead 4 Slots than there are available MIDI Control Change numbers. This means that the Slot buttons on the panel will be used to set the transmitting and receiving Slot focus of panel generated CC messages. This allows you to record and receive parameter changes on the Global MIDI Channel.

If you want to make parameter changes on more than one Nord Lead 4 Slot at the same time, the Slot MIDI Channel approach will be more suitable.

Sequencing: Slot MIDI Channels

Program or record the notes to tracks in the sequencer, tracks that are set to the Slot MIDI Channels. Keyboard and panel actions from the Nord Lead 4 will be transmitted on the Global MIDI Channel. Local may be turned Off, to avoid double triggered sounds.

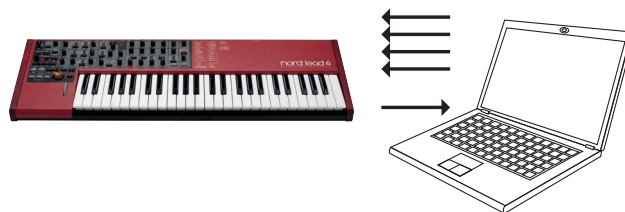

Overdub tracks to record any parameter changes by making these on the Nord Lead 4 panel, or from other MIDI devices set to control the Nord Lead 4.

Continue with the next track, set to another Slot's MIDI Channel.

Control Slots with another keyboard

Use a Performance with some of the Slots controlled from the Lead 4 itself and other Slots from an external keyboard or sequencer, set to corresponding Slot MIDI channel(s).

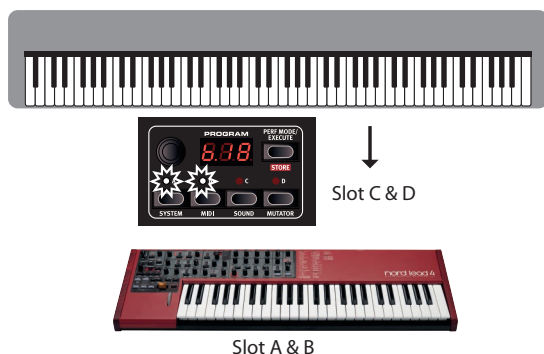

Message types

Program Changes and Bank Select

Program Change messages are transmitted on the Global MIDI channel and are recognized on the Global and/or the Slot MIDI Channels.

Bank Select messages (CC00, CC32) are used to select between the 4 program banks or the two performance banks.

Bank Select messages should be immediately followed by a Program Change message when you wish to select a bank from an external unit.

The Slots will respond to incoming Program Change messages on their individual Slot MIDI Channels. Incoming Program Change messages on the Global MIDI Channel will change the performance, if Performance Mode is enabled.

Incoming Program Change on the Global MIDI Channel will change programs on the focused Slot if Performance Mode is not enabled.

If you do not want the Nord Lead 4 to transmit or respond to Program Change messages, this can be turned off in the MIDI Menu.

Control Change messages

Most of the parameters on the Nord Lead 4 panel will generate a CC message if operated, and the reception of these messages will change the parameter accordingly. A full list of the parameters and their Control Change number is on page 48.

If you do not want the Nord Lead 4 to transmit or respond to Control Change messages, this can be turned off in the MIDI Menu.

Pedal Control Change

A Control pedal transmits CC7 if it is set to volume in the System Menu and CC11 if it is set to be a Morph source. The sustain pedal transmits CC64.

Volume

The output level of an Performance or an individual Slot can be set by transmitting CC7 to the Nord Lead 4 on the Global, or any of the Slot MIDI Channels.

Pan CC

The position of an Performance or a individual Slot in the stereo panorama can be set by transmitting CC10 to the Nord Lead 4 on the Global Channel, or any of the Slot MIDI Channels.

MIDI Local

If a sequencer is set to echo back incoming MIDI data, this can cause double triggered notes if the Nord Lead 4 keyboard is used. If this occurs, set MIDI Local to Off.

MIDI Thru

A Soft Thru Channel can be set in the MIDI Menu. By doing this, incoming note messages on that channel from the USB MIDI or the 5-pin MIDI Input, will be re-routed through the 5-pin MIDI Out connector.

MIDI Clock

The Nord Lead 4 Master Clock will automatically sync to incoming MIDI Clock.

i *The Nord Lead 4 does not transmit MIDI Clock messages. If you want to synchronize several units including the Nord Lead 4, an external MIDI Clock source should be used.*

USB MIDI

If you use a computer running Windows XP, Vista, Windows 7 or Windows 8, install the Nord v3.x USB driver to be able to use the MIDI via USB functionality. This driver is available through Windows Update by just connecting the computer to the Internet with the Nord Lead 4 connected at one of the USB ports. The USB driver can also be installed from the CDROM that accompanied the unit or downloaded from the www.nordkeyboards.com website.

Computers running Mac OSX have a native USB MIDI support for the Nord units. No driver installation is necessary.

Panic

If notes get stuck during a performance, press Panic. This will reset incoming CC messages and send an All Notes Off message to all Slots.



MIDI Dumps

Transmit settings

Complete Program and Performance settings can be transmitted through MIDI as Controller Change or System Exclusive messages. The transmissions are executed in the MIDI Menu.

A Control Change transmission contains the settings of the single Program in focus and can be used to initialize a sequencer track with Program parameters.

Use System Exclusive to store a Program or a complete Performance on a computer or in a sequencer. A System Exclusive transmission can also contain all the Programs or Performances in a Bank.

Receive Programs or Banks

Make sure that the MIDI Channel on the transmitting device matches the Global (or Slot) MIDI Channel on the Nord Lead 4 and start the transmission on the computer/sequencer.

Single Programs will be placed in the Nord Lead 4 edit buffer, you need to Store these if you want to keep them.

The currently active Program Bank in the Nord Lead 4 will be overwritten if a System Exclusive package of a complete Bank is received.

MIDI Controller list

These are the MIDI Control Change numbers used for the Nord Lead 4 parameters.

- Buttons that control “on/off” functions have a Controller value of “0” at the “off” position and a value of “127” at the “on” position.
- Buttons that step through various possibilities start with a Controller value of “0” for the “lowest” setting and then increment for each step upwards. The size of the increments depends on how many possible settings there are.

Nord Lead 4 parameter	MIDI CC
Voice Mode Unison	16
Pitch Bend Range	118
Vib Select	56
Glide Rate	5
Mono Selector	15
Hold	58
Hold Enable	54
Chord Enable	112
Octave Shift	17
Impulse Morph Buttons	70
LFO 1 Rate	19
LFO 1 Waveform	20
LFO 1 Destination	21
LFO 1 Amount	22
LFO 1 Mst Clk	2
LFO 1 Clk Divisions	3
LFO 1 KBS	83
LFO 1 Impsync	59
LFO1/Arp On/Off	91
Arp Tempo	9
Arp Mst Clk	86
Arp Clk Division	87
Arp Direction	89
Arp Run	90
Arp Range	88
Arp KBS	92
Arp Impsync	93
LFO 2 Rate	23
LFO 2 Waveform	85
LFO 2 Destination	24
LFO 2 Amount	25
LFO 2 Mst Clk	18
LFO 2 Clk Divisions	14
LFO 2 KBS	12
LFO 2 Impsync	13
Mod Env Attack	26
Mod Env Decay	27
Mod Env Destination	28
Mod Env Amount	29
Mod Env Rel Mode	109

Nord Lead 4 parameter	MIDI CC
Mod Env Impsync	6
Osc 1 Waveform	30
Osc 1 Wavetable Selection	49
Osc 2 Waveform	31
Osc 2 Semi Tones	78
Osc 2 Fine Tune	33
Osc 2 KBT	34
Osc 2 Noise Res	61
Osc 2 Noise Freq	62
Osc 2 Noise KBT	63
Osc Mod Amount	69
Osc Mod Select	105
Osx Mix	8
Amp Env Attack	73
Amp Env Decay	36
Amp Env Sustain	37
Amp Env Release	72
Amp Velocity	35
Filt Env Attack	38
Filt Env Decay	39
Filt Env Sustain	40
Filt Env Release	41
Filt Keyb Tracking	46
Filter Type	44
Filt Velocity	45
Filter Frequency	74
Filter Resonance	42
Filter Drive	47
Filter Envelope Amount	43
Output Level	71
FX Selection	53
FX On/Off	52
FX Amount	55
Delay Tempo	77
Delay Clk Division	57
Delay Feedback	79
Delay/Reverb Amount	76
Delay Mst Clk	51
Delay / Reverb selection	50
Reverb Bright	94
Reverb Model	96
Delay/Reverb On Off	97
Pattern selection	117
Slot Focus	119
Slot Enable	115
Pan	10
Volume Pedal (if set in System menu)	7
Ctrl Pedal (if set in System menu)	11
Mod Wheel	1
Sustain Pedal	64
Bank Select MSB	0
Bank Select LSB	32

MIDI Implementation Chart

Function		Transmitted	Recognized	Remarks
Basic Channel Default Channel		1 - 16 1 - 16	1 - 16 1 - 16	Indiv. channels for Slot A, B, C & D
Mode	Default Message Altered	Mode 1, 3 X *****	Mode 1, 3 X	
Note Number	True Voice	0-127	0-127	
Velocity	Note ON Note Off	O, v= 1 - 127 X	O, v= 1 - 127 X	
After Touch	Key's Channel	X X	X X	
Pitch Bender		O	O	
Control Change		O	O	See MIDI CC on page 48
Program Change True#		O, 0-98	O, 0-98	Bank Sel: CC00, CC32
System Exclusive		O	O	
System Common	Song Pos Song Sel Tune	X X X	X X X	
System Realtime	Clock Commands	X X	O	
Aux Message	Local on/off All notes off Active Sense Reset			
Number	True Voice			

Mode 1: Omni On, Poly - Mode 2: Omni O, Mono - Mode 3: Omni Off,
Poly - Mode 4: Omni Off, Mono - O = Yes - X = No

13 Appendix

Specifications

General

- 4 octave (49-keys) velocity sensitive keyboard.
- 20 voices.
- Wooden Pitch Stick (n/a on Nord Lead 4R).
- Programmable pitch bend +/- 48 semitones.
- Modulation Wheel (n/a on Nord Lead 4R).
- Master Level Control.
- 2 Morph Sources (Modulation Wheel / Control Pedal, Note Velocity).
- 3 Impulse Morph buttons, with up to 7 combinations per program.

Synth Section

- 4 part multitimbral synth section:
- OSC1: Triangle, Saw, Square, Pulse, PWM, 128 wavetables.
- OSC2: Triangle, Square, Saw, Noise, Sine. Transpose and Fine Tune.
- Oscillator 1 Modulation: Frequency Modulation, Soft and Hard sync with Amount Control.
- Filter: 7 different types of filters with Frequency, Resonance, Keyboard Tracking, Drive and ADSR bipolar (+/-) Envelope control.
- Amplifier Envelope: ADSR controls.
- Modulation Envelope: selectable AD or AR, attack decay/release and bipolar (+/-) Amount controls.
- LFO 1 Waveforms: Square, inverted Saws, Saws & Triangle. Bipolar (+/-) Amount control.
- LFO 1 Destinations: Filter, Osc Mod, Osc Mix, Osc 2 Pitch, Amplitude, Pulse width.
- LFO 2 Waveforms: Square, Inverted Saw, Saw, Random, Sample & Hold, Triangle. Bipolar (+/-) Amount control.
- LFO 2 Destinations: Filter, Osc Mod, Osc 1 & Osc 2 Pitch, Pan, FX.
- Mono Mode: Mono or Legato with Glide-function.

Program Section

- 396 program locations, 4 Banks with 99 Programs.
- 100 Performances, 2 banks with 50 performances.
- Four slots A, B, C & D.
- Octave Shift.

Effect Section

- Crush (bit reduction), Compressor, Drive, Talk 1, Talk 2, Comb filter.
- Delay, synchronizable to master clock. Maxdelay time, 1400 ms.
- Reverb with 3 algorithms and brightness control.

Connections

- 4 Line Level Audio Outputs.
- Stereo Headphone Output.
- Sustain Pedal input.
- Control Pedal input.
- USB-interface with MIDI capabilities.
- MIDI in & out.

Dimensions and weight

Nord Lead 4

- 864 x 94 x 272 mm (34.0 x 3.7 x 10.7 inches).
- 5,3 kg, 11.7 lbs.

Nord Lead 4R

- 466 x 115 x 169 mm (18.3 x 4.5 x 6.6 inches).
- 3,35 kg, 6.6 lbs.



Audio Connections

Headphones

A 1/4" stereo connector for headphones.

⚠ *Playing at a high volume level can result in hearing impairments such as permanent hearing loss.*

ⓘ *Only Slots that are routed to outputs 1 & 2 are present at the headphone output.*

1, 2, 3 & 4 Outputs

Unbalanced line level outputs with 1/4" connectors to connect the Nord Lead 4 to an sound system or recording equipment.

General guide on audio connections

- Make all the connections before you turn on the power to your amplifier.
- Turn **on** the power to your amplifier **last**.
- Turn **off** the power to your amplifier **first**.

The routing of the audio signals to the outputs are made in the System Menu.

MIDI Connections

MIDI OUT

MIDI connection used for transmitting MIDI from the Nord Lead 4 to other units such as sound modules, sequencers or computers.

MIDI IN

MIDI connection used to receive MIDI from other units such as keyboards, sequencers and computers.

USB Connection

The USB connection connects the Nord Lead 4 to a personal computer. The computer can run the Nord Sound Manager application or be used if the Nord Lead 4 operating system needs to be updated.

USB MIDI

The USB connection on the Nord Lead 4 can also transmit and receive MIDI messages.

⚠ *Computers running Microsoft Windows operating systems need a driver for the USB connection to function. The driver can be found on the enclosed Nord Lead 4 CD, or at the Nord web site.*

Pedal Connections

There are two pedal inputs; one for a sustain pedal and one for a control pedal.

Sustain pedal

1/4" connector for a switch type pedal. When a connected pedal is operated, the notes you play will be sustained.

Two kinds of pedal polarities can be used, open or closed. Select the type that applies to your sustain pedal, in the System menu.

Control pedal

1/4" stereo connector for pedals of potentiometer type (also know as expression pedals). This can be used as a source for the Morph function or to control the overall volume.

An expression pedal connected to to the Control Pedal input, must use a stereo connector (Tip-Ring-Sleeve).

The most common pedal models (Roland, Yamaha, Korg and Fatar) are pre-configured in the Nord Lead 4. Select the type of pedal that you use in the System menu.

Display Messages

Message	Description
	Storing
<i>PrO</i>	Memory Protected.
	Mst Clk Tempo
<i>E.C.L</i>	Master Clock is synchronized to external MID Clock, tempo cannot be manually set on the Nord Lead 4.
	Copy and Paste related
<i>CP.x</i>	Copy Slot, where x is a, b, c or D.
<i>PS.x</i>	Pasting a copied Slot to a destination Slot (a, b, c or D).
<i>CP.x</i>	Copy Impulse Morph, x is 1 - 7.
<i>PS.x</i>	Pasting a copy to a destination Impulse Morph (1 - 7).
<i>CPY</i>	Copy Velocity/Wheel Morph.
<i>PSt</i>	Pasting a Velocity/Wheel Morph.
<i>5.0</i>	Copy (and Paste) a setting with value 5.0 (0.0 - 10.0).
<i>FuL</i>	The number of available Morphs in the program was exceeded when pasting.
<i>PrO</i>	Pasting is not possible, Impulse Morph is Protected.
	System Exclusive related
<i>E.Su</i>	Read/Write Error.
<i>E.Si</i>	Size Error.
<i>E.uE</i>	Version Error.
<i>E.Ch</i>	Check Sum Error.
<i>PrO</i>	Memory Protected.

14 Index

A

Arpeggio 26
 Arpeggio directions 26
 Arpeggio range 26
 Attack 30
 Audio Connections 51

B

Band Pass 32
 Bend Range 14

C

Chord Memory 22
 Comb filter 33
 Compressor 33
 Control Change Mode 44
 Control Pedal 51
 Control Pedal Mode 43
 Control Pedal Type 43
 Copy 23
 Crush 33
 Ctrl Pedal Gain 43

D

Decay 30
 Delay 34
 Feedback 34
 On/Off 34
 Delay Mode 45
 Dial 21
 Display 22
 Dly Vib 24
 Drive 33
 Dry/Wet
 Reverb 34
 Dump One 44
 Dump Program Bank 44

E

Envelope Amount 32
 Execute 22
 Expression pedal 51

F

Filter 31
 Drive 32
 Frequency 31
 Resonance 32
 Filter Velocity 33
 Fine Tune 28, 43
 FM 28
 Focus 10
 Freq 31
 FX 33

G

Glide 24
 Global Channel 44
 Global Octave Shift 23

H

Headphones 51
 High Pass 33
 Hold 22
 Hold Enable 22

I

Imp Sync 26, 27
 Impulse Morph 23
 Impulse Morph Protect 43

K

Kbd Sync 45
 Kbt Off 28
 KB Track 32
 Keyboard Note 21
 Keyboard Tracking 32
 Key Click Level 45

L

Ladder M 33
 Ladder TB 33
 Layer 10
 LED Display 22
 Legato 24
 Level 33
 LFO 25
 Amount 25
 Destination Selector 25
 Rate 25
 Waveform Selector 25
 Local 44
 Low Pass 32

M

Master Clock 14, 23
 Master Level 7, 21
 Memory Protect 43
 MIDI 44
 Connections 51
 Controller 48
 LED 21
 MIDI Channel 44
 MIDI Interface 44
 Mod Env
 Amount 27
 Attack 27
 Dec/Rel 27
 Mod Wheel 24
 Mono 24
 Morph 21
 Mode 18
 Range 18
 Morph destinations 21
 Morphing 16
 Morph Lock 23
 Morph Merge 45
 Morph Sources 16
 Mst Clk 23
 Multi Focus 22
 Mutator Menu 45

N

Noise Freq 28
 Noise Res 28
 Note Trig 34

O

Octave Shift 23
 Oscillator 27
 Mix 30
 Osc Mod 28
 Amount 29
 Type 29
 Output 33
 Connections 51
 Output Routing 43

P

Panic 29
 Paste 23
 Pattern 23
 Pedal Connections 51
 Performance Mode 22
 Pitch Bend Mode 44
 Poly arpeggio 26
 Program Change 44
 Program Dial 21
 Programs 9
 Pulse 27

R

Release 31

S

Sawtooth 27
 Selector buttons 8
 Semi tones 28
 Send CC 44
 Shift 24
 Shift Button 8
 Slot Channel 44
 Slot Output 43
 Slots 10, 22
 Soft Thru 44
 Sound Init 28
 Specifications 50
 Split 10, 23
 Store Button 22
 Storing 9
 Sustain 31
 Sustain pedal 51
 Sustain Pedal 43
 Sync 28
 System Menu 43

T

Talk 33
 Tempo 23
 Transpose 43
 Triangle 27
 Type 32

U

Undo 20
 Unison 24
 USB Connection 51

V

Vibrato Amount 45
 Vibrato Rate 45
 Voice Mode 24

W

Wavetable 28
 Wheel 16

FCC Information (U.S.A.)

1. IMPORTANT NOTICE: DO NOT MODIFY THIS UNIT!

This product, when installed as indicated in the instructions contained in this manual, meets FCC requirements. Modifications not expressly approved by Clavia may void your authority, granted by the FCC, to use the product.

2. IMPORTANT: When connecting this product to accessories and/ or another product use only high quality shielded cables. Cable/s supplied with this product **MUST** be used. Follow all installation instructions. Failure to follow instructions could void your FCC authorization to use this product in the USA.

3. Note: This equipment has been tested and found to comply with the limits for a Class B digital device, pursuant to Part 15 of the FCC Rules. These limits are designed to provide reasonable protection against harmful interference in a residential installation. This equipment generates, uses, and can radiate radio frequency energy and, if not installed and used in accordance with the instructions, may cause harmful interference to radio communications. However, there is no guarantee that interference will not occur in a particular installation. If this equipment is found to be the source of interference to radio or television reception, which can be determined by turning the equipment off and on, the user is encouraged to try to correct the interference by one or more of the following measures:

- Reorient or relocate the receiving antenna.
- Increase the separation between the equipment and receiver.
- Connect the equipment into an outlet on a circuit different from that to which the receiver is connected.
- Consult the dealer or an experienced radio/TV technician for help.

This device complies with Part 15 of the FCC Rules. Operation is subject to the following two conditions:

- (1) this device may not cause harmful interference, and
- (2) this device must accept any interference received, including interference that may cause undesired operation.

Unauthorized changes or modification to this system can void the users authority to operate this equipment.

This equipment requires shielded interface cables in order to meet FCC class B Limit.

For Canada

NOTICE

This Class B - digital apparatus complies with Canadian ICES-003.

AVIS

Cet appareil numérique de la classe B - est conforme à la norme NMB-003 du Canada.

DECLARATION OF CONFORMITY Compliance Information Statement

Model Name: Nord Lead 4, Nord Lead 4R

Type of Equipment: Digital Synthesizer

Responsible Party: Clavia DMI AB

Address: P.O. BOX 4214. SE-102 65 Stockholm Sweden

Telephone: +46-8-442 73 60

